



VALVES AND ACTUATORS CATALOG



For the latest product updates, visit us online at johnsoncontrols.com



HVAC Products & Controls



Valve & Damper Actuators



HVAC Valves & Ball Valves

Valves and Actuators Catalog

Electric Damper Actuators	V-17
Pneumatic Damper Actuators	V-94
Threaded Ball Valves and Actuators	V-105
Pressure Independent Valves	V-206
Threaded Globe Valves and Actuators	V-212
Zone and Fan Coil Valves	V-272
Flanged Globe or Ball Valves and Actuators	V-283
Butterfly Valves and Actuators	V-310
Other Valves and Actuators	V-354
Valve Sizing and Cross-Reference	V-389

Valves and Actuators Products Catalog

Table of Contents

Electric Damper ActuatorsV-17

M9102-AGA-2S, -3S and M9104-xxA-2S, -3S Series Electric Non-Spring Return Actuators	V-17
M9104-AGx-2N Electric Non-Spring-Return Actuators	V-20
M9106-xGx-2 Series Electric Non-Spring-Return Actuators	V-22
M9106-AGx-2N0x Series Electric Non-Spring-Return Actuators	V-25
M9109-xGx-2 Series Electric Non-Spring-Return Actuators	V-28
M9116, M9124, and M9132 Series Electric Non-Spring-Return Actuators	V-31
M9203-xxx-2(Z) Series Electric Spring-Return Actuators	V-35
M9208-xxx-x Series Electric Spring-Return Actuators	V-41
M9220 Series Electric Spring-Return Actuators	V-47
M9300 Series Electric Non-Spring Return Actuators	V-52
M9000-3xx Series Weather Shield Enclosures	V-63
Rotary Actuator Accessories	V-65

Pneumatic Damper Actuators . . .V-94

D-3031 Pneumatic Piston Damper Actuator	V-94
D-3062 Pneumatic Piston Damper Actuator	V-95
D-3153, D-3244, D-3246 Pneumatic Actuators for VF Series Butterfly Valves	V-97
D-4070 Pneumatic Piston Damper Actuator	V-98
D-4073 Pneumatic Piston Damper Actuator	V-99
DS-3062 High-Temperature Pneumatic Piston Damper Actuator	V-101
DS-3153 High-Temperature Pneumatic Piston Damper Actuator	V-102

D-9502 Pneumatic Damper Actuator Positioner	V-103
Hardware for Pneumatic Damper Actuators	V-104

Threaded Ball Valves and ActuatorsV-105

PP1 Series Piping Packages for VG1000 Series Ball Valves	V-105
VG1000 Series Two-Way, Stainless Steel Trim, NPT End Connections Ball Valves with Spring-Return Electric Actuators without Switches	V-109
VG1000 Series Two-Way, Plated Brass Trim, NPT End Connections Ball Valves with Non-Spring Return Electric Actuators	V-113
VG1000 Series Three-Way, Plated Brass Trim, NPT End Connections Ball Valves with Non-Spring Return Electric Actuators	V-116
VG1000 Series Two-Way, Plated Brass Trim, NPT End Connections Ball Valves with Spring-Return Electric Actuators without Switches	V-119
VG1000 Series Two-Way, Plated Brass Trim, NPT End Connections Ball Valves with Spring-Return Electric Actuators with Switches	V-122
VG1000 Series Three-Way, Plated Brass Ball and Stem, NPT End Connections Ball Valve Assemblies with End Switches	V-125
VG1000 Series Three-Way, Plated Brass Trim, NPT End Connections Ball Valves with Spring-Return Electric Actuators without Switches	V-128
VG1000 Series Two-Way, Stainless Steel Trim, NPT End Connections Ball Valves with Non-Spring Return Electric Actuators	V-131
VG1000 Series Three-Way, Stainless Steel Trim, NPT End Connections Ball Valves with Non-Spring Return Electric Actuators	V-136
VG1000 Series Two-Way, Stainless Steel Trim, NPT End Connections Ball Valves with Spring-Return Electric Actuators with Switches	V-141

Table of Contents

VG1000 Series Three-Way, Stainless Steel Trim, NPT End Connections Ball Valves with Spring-Return Electric Actuators without Switches	V-145
VG1000 Series Three-Way, Stainless Steel Trim, NPT End Connections Ball Valves with Spring-Return Electric Actuators with Switches	V-149
VG1000 Series Forged Brass Ball Valves for Assembly in the Field	V-153
VG1000 Smart Ball Valves	V-157
VG1000 Smart Ball Valves with FX-PCV Programmable VAV Box Controller Series	V-161
VG1000 Series Sweat End Connection Plated Brass Trim Ball Valves	V-165
VG1000 Series Sweat End Connection Stainless Steel Trim Ball Valves	V-168
VG1000 Series Press End Connection Stainless Steel Trim Ball Valves	V-171
VA9905 Series Actuators - VG1600 Series 270° Six-Way Ball Valves	V-174
VA9104 Series Electric Non-Spring Return Valve Actuators	V-177
VA9203-xxx-xx Series Electric Spring-Return Actuators	V-179
VA9208-xxx-xx Series Electric Spring-Return Actuators	V-183
VA9300 Series Electric Non-Spring Return Valve Actuators	V-188
M9000-700 Universal Ball Valve Linkage Kit	V-195
M9000-51x Series Ball Valve Linkage Kits	V-204
Pressure Independent Valves	V-206
VP140 1/2 Inch to 2 Inch (DN15-DN50) Pressure Independent Control Valve	V-206
Threaded Globe Valves and Actuators	V-212
VG7000 Series Brass Trim Globe Valves with VA-715x Series Electric Actuators	V-212
VG7000 Series Brass Trim Globe Valves with VA-4233 Series Spring-Return Electric Actuators	V-215
VG7000 Series Brass Trim Globe Valves with VA7800 Series Electric Actuators	V-219
VG7000 Series Stainless Steel Trim Globe Valves with VA-715x Series Electric Actuators	V-221
VG7000 Series Stainless Steel Trim Globe Valves with VA-4233 Series Spring-Return Electric Actuators	V-223
VG7000 Series Stainless Steel Trim Globe Valves with VA7800 Series Electric Actuators	V-225
VG7000 Series Brass Trim Globe Valves with V-3801 Compact Pneumatic Actuators	V-227
VG7000 Series Brass Trim Globe Valves with V-3000 Pneumatic Actuators	V-230
VG7000 Series Brass Trim Globe Valves with MP82 Series Pneumatic Actuators	V-236
VG7000 Series Stainless Steel Trim Globe Valves with V-3000 Pneumatic Actuators	V-238
VG7000 Series Stainless Steel Trim Globe Valves with MP82 Series Pneumatic Actuators	V-240
VG7000 Series Stainless Steel Trim Globe Valves with MP84 Series Pneumatic Actuators	V-242
VG7000 Series Bronze Globe Valves for Assembly in the Field	V-244
VA-715x Series Electric Valve Actuator	V-250
VA-748x Electric Valve Actuators	V-251
VA-4233 Series Electric Valve Actuators	V-253
VA-720x Series Electric Valve Actuator	V-255
VA-7700 Series Electric Non-Spring Return Actuators	V-256
VA7800 Series Electric Valve Actuators	V-258
V-3801-8001 Pneumatic Valve Actuator	V-262
V-3000-8012, V-3000-8003 Pneumatic Valve Actuators	V-263
MP8000 Series Pneumatic Valve Actuators	V-264
Repair Parts and Replacement Diaphragms for V-3000 Series Actuators	V-266

Table of Contents

VG7000 Series Bronze Globe Valves, Maintenance and Repair	V-267
V-9502 Series Pneumatic Valve Actuator Positioners	V-269
Zone and Fan Coil Valves	V-272
J Series Electric Zone Valves — Two-Way Spring Open (Normally Open), On/Off Control	V-272
J Series Electric Zone Valves — Two-Way Spring Closed (Normally Closed), On/Off Control	V-274
J Series Electric Zone Valves — Two-Way Spring Open (Normally Open), Modulating Control	V-276
J Series Electric Zone Valves — Three-Way Spring Return, On/Off Control	V-277
J Series Electric Zone Valves for Assembly in the Field	V-279
Flanged Globe or Ball Valves and Actuators	V-283
VG1000 Series Flanged Ball Valves	V-283
VG1000 Series Flanged Ball Valves for Assembly in the Field	V-290
VG2000 Series Electric Cast Iron Flanged Globe Valves	V-292
VG2000 Series Pneumatic Cast Iron Flanged Globe Valves	V-297
VG2000 Series Cast Iron Flanged Globe Valves for Assembly in the Field	V-300
VA-3100 Series Electric Valve Actuators	V-305
VA-6100 Series Electric Valve Actuators	V-306
M9000-53x Series Cast Iron Flanged Valve Linkage Kits	V-307
VG2000 Series Cast Iron Flanged Globe Valves, Maintenance and Repair	V-309
Butterfly Valves and Actuators .V-310	
M9000 Electrically Actuated, Standard-Pressure, Standard-Temperature, Two-Way Butterfly Valves (without Weather Shield)	V-310
M9000 Electrically Actuated, Standard-Pressure, Standard-Temperature, Two-Way Butterfly Valves (with Weather Shield)	V-313
VF Series Two-Way, Industrial-Grade, Non- Spring Return, VA-907x Series Electric Actuated, Standard-Pressure, Standard- Temperature Butterfly Valve Assemblies	V-315
Two-Way, Spring-Return, Low-Pressure D-3000 Series Pneumatically Actuated, Standard-Pressure, Standard-Temperature Butterfly Valve Assemblies	V-317
Two-Way, Industrial-Grade, Spring-Return, V-919x Series High-Pressure Pneumatically Actuated, Standard-Pressure, Standard-Temperature Butterfly Valve Assemblies	V-319
Two-Way, Industrial-Grade, Non-Spring-Return, V-909x Series High-Pressure Pneumatically Actuated, Standard-Pressure, Standard-Temperature Butterfly Valve Assemblies	V-321
Two-Way, Industrial-Grade, Manually Operated, Standard-Pressure, Standard-Temperature Butterfly Valve Assemblies	V-323
M9000 Series Electrically Actuated, Standard-Pressure, Standard-Temperature, Three-Way Butterfly Valves (without Weather Shield)	V-325
M9000 Series Electrically Actuated, Standard-Pressure, Standard-Temperature, Three-Way Butterfly Valves (with Weather Shield)	V-327
VF Series Three-Way, Industrial-Grade, Non-Spring-Return, VA-907x Series Electric Actuated, Standard-Pressure, Standard-Temperature Butterfly Valve Assemblies	V-330
Three-Way, Spring-Return, Low-Pressure D-3000 Series Pneumatically Actuated, Standard-Pressure, Standard-Temperature Butterfly Valve Assemblies	V-332

Table of Contents

Three-Way, Industrial-Grade, Spring-Return, V-919x Series High-Pressure Pneumatically Actuated, Standard-Pressure, Standard-Temperature Butterfly Valve Assemblies	V-334	V-4000-1 Small Pneumatic Actuator for Small Control Valves	V-362
Three-Way, Industrial-Grade, Non-Spring-Return, V-909x Series High-Pressure Pneumatically Actuated, Standard-Pressure, Standard-Temperature Butterfly Valve Assemblies	V-336	Repair Parts for Use with V-9502 Pneumatic Valve Actuator Positioner	V-363
VF Series Two-Way, Industrial-Grade, Non-Spring Return, VA-907X Series Electric Actuated, High-Pressure, High-Temperature Butterfly Valve Assemblies	V-338	Repair Parts for Use with Electric or Pneumatic VT Series Terminal Unit Valves 1/2 in., Two-Way and Three-Way	V-364
Two-Way, Industrial-Grade, Non-Spring-Return, V-909x Series High-Pressure Pneumatically Actuated, High-Pressure, High-Temperature Butterfly Valve Assemblies	V-340	Repair Parts for 1/2 in. Flare Valves for Use with V-3766, V-3966, V-4332, VB-3766, VB-3966, VB-4332, AV-8050, AV-8051, and AV-8052 (Flare Valve Assemblies)	V-365
Two-Way, Industrial-Grade, Spring-Return, V-919x Series High-Pressure Pneumatically Actuated, High-Pressure, High-Temperature Butterfly Valve Assemblies	V-342	Repair Parts for Use with V-4334 5/8 in. Flare Valve	V-366
Two-Way, Manually Operated, High-Pressure, High-Temperature Butterfly Valve Assemblies	V-344	Repair Parts for Use with V-4440 Water Valve 1/2 and 5/8 in. for Three- and Four-Pipe Systems	V-367
VA-9070 Series Electric Rotary Actuators for Two-Position and Modulating Service	V-346	Repair Parts for Cage Trim Valve for Use with V-3754 with Actuator and VB-3754 without Actuator (Including 1/2 in.)	V-368
V-9000 Series Rotary Motion Rack and Pinion Pneumatic Actuators for Butterfly Valves	V-349	Repair Parts for Use with V-4324 with Actuator and VB-4324 without Actuator (Including 1/2 in.)	V-369
V-9000-500 Positioner	V-353	Repair Parts for Use with V-3854 with Oval Top Actuator	V-370
Other Valves and Actuators	V-354	Repair Parts for Use with V-5254, V-5464, and V-5844 with V-5252 Size 4R Actuators	V-371
V-3766, V-3966, and V-4332 Brass Pneumatic Flare Valves, 1/2 in. Two-Way and Three-Way	V-354	Repair Parts for Use with V-3974 with Actuator and VB-3974 without Actuator (Including 1/2 in.)	V-372
V-3802-1 Oval Top Actuator	V-356	Repairs Parts for Cast Iron Flanged Globe Valves (2-1/2 through 6 in.) for Use with V-5252 and VB-3752	V-373
V-4334 Flare Valve	V-357	Repairs Parts for Cast Iron Flanged Globe Valves (2-1/2 through 6 in.) for Use with V-5462 and VB-3970	V-374
V-4440 Series Water Valve 1/2 and 5/8 in. for Three- and Four-Pipe Systems	V-358	Repairs Parts for Cast Iron Flanged Globe Valves (2-1/2 through 6 in.) for Use with V-5842 and VB-4322	V-375
VB-3766, VB-3966, VB-4332 Series Brass Flare Valve Bodies, 1/2 in. Two-Way and Three-Way	V-359	Repair Parts for Use with V-7216 Two-Way Normally Open Steam or Water Valve	V-376
V-3000 Series Pneumatic Actuator	V-361	Repair Parts for Use with V-7416 Two-Way Normally Closed Steam or Water Valve	V-377

Table of Contents

Repair Parts for Use with V-3752 Normally Open Valves	V-378	Inner Valve Reconditioning Kits: 3/4 to 2 in.	V-387
Repair Parts for Use with V-3755 Normally Open Valves, 1/2 through 2 in.	V-379	Inner Valve Reconditioning Kits: 2-1/2 to 6 in.	V-388
Repair Parts for Use with VB-3752 Normally Open Steam and Water Valves	V-380	Valve Sizing and Cross-Reference.	V-389
Repair Parts For Use with V-3800 Normally Open Valves 1/2 and 3/4 in.	V-381	Sizing Water Valves	V-389
Repair Parts for Use with V-5210 High-Pressure Normally Open Valve 2-1/2 through 4 in. Cast Iron 250 lb ANSI Raised Flanges	V-382	Valve Sizing Steam Applications	V-401
Repair Parts for Use with V-5410 High-Pressure Normally Closed Valves 2-1/2 through 4 in. Cast Iron 250 lb ANSI Raised Flanges.	V-383	Cross-Reference of VT Series Threaded (NPT) Valves to VG7000 Series Valves	V-405
Valve Spring Kits Sorted by Valve Code Number	V-384	Cross-Reference of VT Series Union End Valves to VG7000 Series Valves	V-407
Inner Valve Reconditioning Kits: 1/2 to 5/8 in.	V-386	Cross-Reference of Cage Trim Valves to VG7000 Series Valves	V-412
		Cross-Reference of V-7x16 Series Valves to VG7000 Series Valves	V-414

Table of Contents

Code Number Index

D			M		
D-3031-3	V-94	JM2323	V-276	M9000-530	V-307
D-3031-4	V-94	JM2327	V-276	M9000-531	V-307
D-3062-1	V-95	JM2413	V-276	M9000-532	V-307
D-3062-2	V-95	JM2417	V-276	M9000-533	V-307
D-3062-3	V-95	JM2427	V-276	M9000-534	V-307
D-3062-4	V-95	JM2517	V-276	M9000-535	V-307
D-3062-41	V-95	JS2211	V-272, V-274	M9000-536	V-307
D-3153-5120	V-97	JS2212	V-272, V-274	M9000-537	V-307
D-3153-5130	V-97	JS2213	V-272, V-274	M9104-AGA-2N	V-20
D-3244-5100	V-97	JS2221	V-272, V-274, V-275	M9104-AGS-2N	V-20
D-3244-5110	V-97	JS2222	V-272, V-274, V-275	M9106-AGA-2	V-22
D-3246-5100	V-97	JS2223	V-272, V-274, V-275	M9106-AGA-2N01	V-25
D-3246-5110	V-97	JS2312	V-272, V-274	M9106-AGA-2N02	V-25
D-4070-1	V-98	JS2313	V-272, V-274	M9106-AGC-2	V-22
D-4070-2	V-98	JS2322	V-272, V-274, V-275	M9106-AGF-2	V-22
D-4070-6001	V-98	JS2323	V-272, V-274, V-275	M9106-AGS-2N02	V-25
D-4070-6002	V-98	JS2343	V-272, V-274, V-275	M9106-GGA-2	V-22
D-4073-1	V-99	JS2417	V-272, V-274	M9106-GGC-2	V-22
D-4073-2	V-99	JS2427	V-272, V-274, V-275	M9106-IGA-2	V-22
D-4073-3	V-99	JS2517	V-272, V-274	M9106-IGC-2	V-22
D-4073-4	V-99	JS3213	V-277	M9109-AGA-2	V-28
D-4073-5	V-99	JS3223	V-277	M9109-AGC-2	V-28
D-4073-6	V-99	JS3315	V-277	M9109-GGA-2	V-28
D-4073-6001	V-99	JS3325	V-277	M9109-GGC-2	V-28
D-4073-6002	V-99	JS3343	V-277	M9116-AGA-2	V-31
D-4073-6003	V-99	JS3417	V-277	M9116-AGC-2	V-31
D-4073-7	V-99	JS3427	V-277	M9116-AGD-2	V-31
D-9502-12	V-103	JS3517	V-277	M9116-AGE-2	V-31
D-9502-5	V-103	JT2211	V-272, V-274	M9116-GGA-2	V-31
D-9502-8	V-103	JT2212	V-272, V-274	M9116-GGC-2	V-31
D-9502-9	V-103	JT2213	V-272, V-274	M9116-HGA-2	V-31
DS-3062-1	V-101	JT2221	V-272, V-274, V-275	M9116-HGC-2	V-31
DS-3153-1	V-102	JT2222	V-272, V-274, V-275	M9116-JGA-2	V-31
DS-3153-2	V-102	JT2223	V-272, V-274, V-275	M9116-JGC-2	V-31
DS-3153-4	V-102	JT2312	V-272, V-274	M9124-AGA-2	V-32
DS-3153-5	V-102	JT2313	V-272, V-274	M9124-AGC-2	V-32
		JT2322	V-272, V-274, V-275	M9124-AGD-2	V-32
		JT2323	V-272, V-274, V-275	M9124-AGE-2	V-32
		JT2343	V-272, V-274, V-275	M9124-GGA-2	V-32
		JT2417	V-272, V-274	M9124-GGC-2	V-32
		JT2427	V-272, V-274, V-275	M9124-HGA-2	V-32
		JT2517	V-272, V-274	M9124-HGC-2	V-32
		JT3213	V-277	M9124-JGA-2	V-32
		JT3223	V-277	M9124-JGC-2	V-32
		JT3315	V-277	M9132-AGA-2	V-32
		JT3325	V-277	M9132-AGC-2	V-32
		JT3343	V-277	M9132-AGE-2	V-32
		JT3417	V-277	M9132-GGA-2	V-32
		JT3427	V-277	M9132-GGC-2	V-32
		JT3517	V-277		

Note: Page numbers in *italics* denote pages where the product code number appears, but not as the main part.

Code Number Index

V-4334-1002	V-357	V-9502-23	V-269	VA9208-BDC-3	V-184
V-4440-1001	V-358	V-9502-3	V-269	VA9208-BGA-3	V-184
V-4440-1002	V-358	V-9502-4	V-269	VA9208-BGC-3	V-184
V-4440-1003	V-358	V-9502-5	V-269	VA9208-GGA-2	V-184
V-4440-1004	V-358	V-9502-6	V-269	VA9208-GGA-3	V-184
V-4440-1005	V-358	V-9502-76	V-269	VA9208-GGC-3	V-184
V-4440-1008	V-358	V-9502-8033	V-269	VB-3766-1	V-354, V-359
V-4440-1009	V-358	V-9502-90	V-269	VB-3766-2	V-354, V-359
V-4440-1011	V-358	V-9502-91	V-269	VB-3766-3	V-354, V-359
V-9092-1	V-349	V-9502-95	V-269	VB-3966-1	V-354, V-359
V-9093-1	V-349	VA-3100-AGA	V-305	VB-3966-2	V-354, V-359
V-9094-1	V-349	VA-3100-AGC	V-305	VB-4332-4	V-354, V-359
V-9094-2	V-349	VA-3100-HGC	V-305	VB-4332-5	V-354, V-359
V-9096-1	V-349	VA-4233-AGA-2	V-253	VFC-020HB	V-317, V-319, V-321
V-9097-1	V-349	VA-4233-AGC-2	V-253	VFC-024ZE	V-342
V-9098-1	V-349	VA-4233-BGA-2	V-253	VFC-025HB	V-317, V-319, V-321
V-9193-12	V-349, V-350	VA-4233-BGC-2	V-253	VFC-025VE	V-340, V-342
V-9193-13	V-349, V-350	VA-4233-GGA-2	V-253	VFC-025ZE	V-340
V-9193-14	V-349, V-350	VA-4233-GGA-2MP	V-253	VFC-030HB	V-317, V-319, V-321
V-9193-16	V-349, V-350	VA-4233-GGC-2	V-253	VFC-030VE	V-340, V-342
V-9194-12	V-349, V-350	VA-6100-AGC	V-306	VFC-030ZE	V-340, V-342
V-9194-13	V-349, V-350	VA-6100-HGC	V-306	VFC-040HB	V-317, V-319, V-321
V-9194-14	V-349, V-350	VA-7150-1001	V-250	VFC-040LB	V-317, V-319, V-321
V-9194-15	V-349, V-350	VA-7152-1001	V-250	VFC-040VE	V-340, V-342
V-9194-16	V-349, V-350	VA-7153-1001	V-250	VFC-040ZE	V-340, V-342
V-9194-22	V-349, V-350	VA-7200-1001	V-255	VFC-050HB	V-317, V-319, V-321
V-9194-23	V-349, V-350	VA-7202-1001	V-255	VFC-050LB	V-317, V-319, V-321
V-9194-24	V-349, V-350	VA-7203-1001	V-255	VFC-050VE	V-340, V-342
V-9194-25	V-349	VA7810-ADC-2	V-258	VFC-050ZE	V-340, V-342
V-9194-26	V-349	VA7810-AGA-2	V-258	VFC-060HB	V-317, V-319, V-321
V-9195-13	V-349, V-350	VA7810-AGC-2	V-258	VFC-060LB	V-317, V-319, V-321
V-9195-15	V-349, V-350	VA7810-HGA-2	V-258	VFC-060VE	V-340, V-342
V-9196-12	V-350	VA7810-HGC-2	V-258	VFC-060ZE	V-340, V-342
V-9196-13	V-350	VA7820-HGA-2	V-258	VFC-080HB	V-317, V-319, V-321
V-9196-14	V-350	VA7820-HGC-2	V-258	VFC-080LB	V-317, V-319, V-321
V-9196-15	V-350	VA7830-HGA-2	V-258	VFC-080VE	V-340, V-342
V-9196-16	V-350	VA7830-HGC-2	V-258	VFC-080ZE	V-340, V-342
V-9197-12	V-350	VA9203-AGA-2Z	V-179	VFC-100HB	V-319, V-321
V-9197-13	V-350	VA9203-AGB-2Z	V-179	VFC-100LB	V-317, V-319, V-321
V-9197-14	V-350	VA9203-BGA-2	V-179		
V-9197-15	V-350	VA9203-BGB-2	V-179		
V-9197-16	V-350	VA9203-BUA-2	V-179		
V-9198-12	V-350	VA9203-BUB-2	V-179		
V-9198-13	V-350	VA9203-GGA-2Z	V-179		
V-9198-14	V-350	VA9203-GGB-2Z	V-179		
V-9198-15	V-350	VA9208-AGA-2	V-184		
V-9198-16	V-350	VA9208-AGA-3	V-184		
V-9502-1	V-269	VA9208-AGC-3	V-184		
V-9502-15	V-269	VA9208-BAA-3	V-184		
V-9502-16	V-269	VA9208-BAC-3	V-184		
V-9502-2	V-269	VA9208-BDA-3	V-184		

Note: Page numbers in *italics* denote pages where the product code number appears, but not as the main part.

Code Number Index

VFC-100VE . . . V-340, V-342	VFM-025VE V-344	VG1241BL . . V-113, V-119, V-120, V-122, V-123
VFC-100ZE . . . V-340, V-342	VFM-025ZE V-344	VG1241BN . . V-113, V-119, V-120, V-122, V-123
VFC-120HB . . . V-319, V-321	VFM-030HB V-323	VG1241CL . . V-113, V-119, V-120, V-122, V-123
VFC-120LB . . . V-319, V-321	VFM-030VE V-344	VG1241CN . . V-113, V-119, V-120, V-122, V-123
VFC-120VE . . . V-340, V-342	VFM-030ZE V-344	VG1241CP . . V-113, V-119, V-120, V-122, V-123
VFC-120ZE . . . V-340, V-342	VFM-040HB V-323	VG1241DN . . V-119, V-120, V-122, V-123
VFC-140HC . . . V-319, V-321	VFM-040VE V-344	VG1241DP . . V-119, V-120, V-122, V-123
VFC-140LC . . . V-319, V-321	VFM-040ZE V-344	VG1241DR . . V-119, V-120, V-122, V-123
VFC-140VE . . . V-340, V-342	VFM-050HB V-323	VG1241EP . . V-119, V-120, V-122, V-123
VFC-140ZE V-340	VFM-050VE V-344	VG1241ER . . V-119, V-120, V-122, V-123
VFC-160HC . . . V-319, V-321	VFM-050ZE V-344	VG1241ES . . V-119, V-120, V-122, V-123
VFC-160LC . . . V-319, V-321	VFM-060HB V-323	VG1241FR . . V-119, V-120, V-122, V-123
VFC-160VE V-340	VFM-060VE V-344	VG1241FS . . V-119, V-120, V-122, V-123
VFC-180HC . . . V-319, V-321	VFM-060ZE V-344	VG1241FT . . V-119, V-120, V-122, V-123
VFC-180LC . . . V-319, V-321	VFM-080HB V-323	VG1245AD . . V-109, V-110, V-111, V-131, V-132, V-141, V-142, V-143
VFC-200HC . . . V-319, V-321	VFM-080VE V-344	VG1245AE . . V-109, V-110, V-111, V-131, V-132, V-141, V-142, V-143
VFC-200LC . . . V-319, V-321	VFM-080ZE V-344	VG1245AF . . V-109, V-110, V-111, V-131, V-132, V-141, V-142, V-143
VFD-020HB . . . V-332, V-334, V-336	VFM-100HB V-323	VG1245AG . . V-109, V-110, V-111, V-131, V-132, V-141, V-142, V-143
VFD020HB V-325	VFM-100VE V-344	VG1245AL . . V-109, V-110, V-111, V-131, V-132, V-141, V-142, V-143
VFD-025HB . . . V-332, V-334, V-336	VFM-100ZE V-344	VG1245AN . . V-109, V-110, V-111, V-131, V-132, V-141, V-142, V-143
VFD025HB V-325	VFM-120HB V-323	VG1245BG . . V-109, V-110, V-111, V-131, V-132, V-141, V-142, V-143
VFD-030HB . . . V-332, V-334, V-336	VFM-120VE V-344	
VFD030HB V-325	VFM-120ZE V-344	
VFD-040HB . . . V-332, V-334, V-336	VFM-140HC V-323	
VFD040HB V-325	VFM-140VE V-344	
VFD-040LB . . . V-332, V-334, V-336	VFM-140ZE V-344	
VFD040LB V-325	VFM-160HC V-323	
VFD-050HB . . . V-332, V-334, V-336	VFM-180HC V-323	
VFD-050LB . . . V-332, V-334, V-336	VFM-200HC V-323	
VFD050LB V-325	VFN020HB . . . V-310, V-311	
VFD-060HB . . . V-332, V-334, V-336	VFN025HB . . . V-310, V-311	
VFD-060LB . . . V-332, V-334, V-336	VFN030HB . . . V-310, V-311	
VFD060LB V-325	VFN040HB . . . V-310, V-311	
VFD-080HB . . . V-334, V-336	VFN040LB . . . V-310, V-311	
VFD-080LB . . . V-332, V-334, V-336	VFN050HB V-311	
VFD-100HB . . . V-334, V-336	VFN050LB . . . V-310, V-311	
VFD-100LB . . . V-334, V-336	VFN060LB V-311	
VFD-120HB . . . V-334, V-336	VG1241AD . . . V-113, V-119, V-120, V-122, V-123	
VFD-120LB . . . V-334, V-336	VG1241AE . . . V-113, V-119, V-120, V-122, V-123	
VFM-020HB V-323	VG1241AF . . . V-113, V-119, V-120, V-122, V-123	
VFM-025HB V-323	VG1241AG . . . V-113, V-119, V-120, V-122, V-123	
	VG1241AL . . . V-113, V-119, V-120, V-122, V-123	
	VG1241AN . . . V-113, V-119, V-120, V-122, V-123	
	VG1241BG . . . V-113, V-119, V-120, V-122, V-123	

Note: Page numbers in *italics* denote pages where the product code number appears, but not as the main part.

Code Number Index

VG1245BL . . V-109, V-110, V-111, V-131, V-132, V-141, V-142, V-143	VG1275BG . . V-168, V-169	VG1841ER . . V-125, V-126, V-128, V-129
VG1245BN . . V-109, V-110, V-111, V-131, V-132, V-141, V-142, V-143	VG1275BL . . . V-168, V-169	VG1841ES . . V-125, V-126, V-128, V-129
VG1245CL . . V-109, V-110, V-111, V-131, V-132, V-141, V-142, V-143	VG1275BN . . . V-168, V-169	VG1841FR . . V-125, V-126, V-128, V-129
VG1245CN . . V-109, V-110, V-111, V-131, V-132, V-141, V-142, V-143	VG1275CL . . . V-168, V-169	VG1841FS . . V-125, V-126, V-128, V-129
VG1245CP . . V-109, V-110, V-111, V-131, V-132, V-141, V-142, V-143	VG1275CN . . . V-168, V-169	VG1841FT . . V-125, V-126, V-128, V-129
VG1245DN . . V-109, V-110, V-111, V-141, V-142, V-143	VG1275CP . . . V-168, V-169	VG1845AD . . V-136, V-137, V-145, V-146, V-147, V-149, V-150, V-151
VG1245DP . . V-109, V-110, V-111, V-141, V-142, V-143	VG1295AD . . . V-171, V-172	VG1845AE . . V-136, V-137, V-145, V-146, V-147, V-149, V-150, V-151
VG1245DR . . V-109, V-110, V-111, V-141, V-142, V-143	VG1295AE . . . V-171, V-172	VG1845AF . . V-136, V-137, V-145, V-146, V-147, V-149, V-150, V-151
VG1245EP . . V-109, V-110, V-111, V-141, V-142, V-143	VG1295AF . . . V-171, V-172	VG1845AG . . V-136, V-137, V-145, V-146, V-147, V-149, V-150, V-151
VG1245ER . . V-109, V-110, V-111, V-141, V-142, V-143	VG1295AG . . . V-171, V-172	VG1845AL . . V-136, V-137, V-145, V-146, V-147, V-149, V-150, V-151
VG1245ES . . V-109, V-110, V-111, V-141, V-142, V-143	VG1295AL . . . V-171, V-172	VG1845AN . . V-136, V-137, V-145, V-146, V-147, V-149, V-150, V-151
VG1245FR . . V-109, V-110, V-111, V-141, V-142, V-143	VG1295AN . . . V-171, V-172	VG1845BG . . V-136, V-137, V-145, V-146, V-147, V-149, V-150, V-151
VG1245FS . . V-109, V-110, V-111, V-141, V-142, V-143	VG1295BG . . . V-171, V-172	VG1845BL . . V-136, V-137, V-145, V-146, V-147, V-149, V-150, V-151
VG1245FT . . V-109, V-110, V-111, V-141, V-142, V-143	VG1295BL . . . V-171, V-172	VG1845BN . . V-136, V-137, V-145, V-146, V-147, V-149, V-150, V-151
VG1271AD . . . V-165, V-166	VG1295BN . . . V-171, V-172	VG1845CL . . V-136, V-137, V-145, V-146, V-147, V-149, V-150, V-151
VG1271AE . . . V-165, V-166	VG1295CL . . . V-171, V-172	VG1845CN . . V-136, V-137, V-145, V-146, V-147, V-149, V-150, V-151
VG1271AF . . . V-165, V-166	VG1295CN . . . V-171, V-172	VG1845CP . . V-136, V-137, V-145, V-146, V-147, V-149, V-150, V-151
VG1271AG . . . V-165, V-166	VG1295CP . . . V-171, V-172	VG1845DN . . V-145, V-146, V-147, V-149, V-150, V-151, V-152
VG1271AL . . . V-165, V-166	VG1841AD . . . V-116, V-125, V-126, V-128, V-129	
VG1271AN . . . V-165, V-166	VG1841AE . . . V-116, V-125, V-126, V-128, V-129	
VG1271BG . . . V-165, V-166	VG1841AF . . . V-116, V-125, V-126, V-128, V-129	
VG1271BL . . . V-165, V-166	VG1841AG . . . V-116, V-125, V-126, V-128, V-129	
VG1271BN . . . V-165, V-166	VG1841AL . . . V-116, V-125, V-126, V-128, V-129	
VG1271CL . . . V-165, V-166	VG1841AN . . . V-116, V-125, V-126, V-128, V-129	
VG1271CN . . . V-165, V-166	VG1841BG . . . V-116, V-125, V-126, V-128, V-129	
VG1271CP . . . V-165, V-166	VG1841BL . . . V-116, V-125, V-126, V-128, V-129	
VG1275AD . . . V-168, V-169	VG1841BN . . . V-116, V-125, V-126, V-128, V-129	
VG1275AE . . . V-168, V-169	VG1841CL . . . V-116, V-125, V-126, V-128, V-129	
VG1275AF . . . V-168, V-169	VG1841CN . . . V-116, V-125, V-126, V-128, V-129	
VG1275AG . . . V-168, V-169	VG1841CP . . . V-116, V-125, V-126, V-128, V-129	
VG1275AL . . . V-168, V-169	VG1841DN . . . V-125, V-126, V-128, V-129	
VG1275AN . . . V-168, V-169	VG1841DP . . . V-125, V-126, V-128, V-129	
	VG1841DR . . . V-125, V-126, V-128, V-129	
	VG1841EP . . . V-125, V-126, V-128, V-129	

Note: Page numbers in *italics* denote pages where the product code number appears, but not as the main part.

Code Number Index

VG1845DP . . . V-145, V-146, V-147, V-149, V-150, V-151, V-152	VG1875AG . . . V-168, V-169, V-170	VG2231UN . . . V-298, V-300
VG1845DR . . . V-145, V-146, V-147, V-149, V-150, V-151, V-152	VG1875AL . . . V-168, V-169, V-170	VG2231VM . . . V-292, V-293, V-294, V-295, V-298, V-300, V-301, V-302, V-303
VG1845EP . . . V-145, V-146, V-147, V-149, V-150, V-151, V-152	VG1875AN . . . V-168, V-169, V-170	VG2231VN . . . V-298, V-300, V-303
VG1845ER . . . V-145, V-146, V-147, V-149, V-150, V-151, V-152	VG1875BG . . . V-168, V-169, V-170	VG2231WM . . . V-293, V-294, V-303
VG1845ES . . . V-145, V-146, V-147, V-149, V-150, V-151, V-152	VG1875BL . . . V-168, V-169, V-170	VG2231WN . . . V-292, V-295, V-298, V-300, V-301, V-302
VG1845FR . . . V-146, V-147, V-149, V-150, V-151, V-152	VG1875BN . . . V-168, V-169, V-170	VG2231YN . . . V-292, V-295, V-298, V-300, V-301, V-303
VG1845FS . . . V-146, V-147, V-149, V-150, V-151, V-152	VG1875CL . . . V-168, V-169, V-170	VG2431TM . . . V-298, V-300
VG1845FT . . . V-146, V-147, V-149, V-150, V-151, V-152	VG1875CN . . . V-168, V-169, V-170	VG2431UM . . . V-298, V-300
VG1871AD . . . V-165, V-166, V-167	VG1875CP . . . V-168, V-169, V-170	VG2431UN . . . V-298, V-300
VG1871AE . . . V-165, V-166, V-167	VG1895AD . . . V-171, V-172, V-173	VG2431VM . . . V-298, V-300
VG1871AF . . . V-165, V-166, V-167	VG1895AE . . . V-171, V-172, V-173	VG2431VN . . . V-298, V-300
VG1871AG . . . V-165, V-166, V-167	VG1895AF . . . V-171, V-172, V-173	VG2431WN . . . V-298, V-300
VG1871AL . . . V-165, V-166, V-167	VG1895AG . . . V-171, V-172, V-173	VG2431YN . . . V-298, V-300
VG1871AN . . . V-165, V-166, V-167	VG1895AL . . . V-171, V-172, V-173	VG2831TM . . . V-292, V-293, V-294, V-295, V-298, V-300, V-301, V-302, V-303
VG1871BG . . . V-165, V-166, V-167	VG1895AN . . . V-171, V-172, V-173	VG2831UM . . . V-292, V-293, V-294, V-295, V-298, V-300, V-301, V-302, V-303
VG1871BL . . . V-165, V-166, V-167	VG1895AL . . . V-171, V-172, V-173	VG2831UN . . . V-298, V-300
VG1871BN . . . V-165, V-166, V-167	VG1895AN . . . V-171, V-172, V-173	VG2831VM . . . V-292, V-293, V-294, V-295, V-298, V-300, V-301, V-302, V-303
VG1871CL . . . V-165, V-166, V-167	VG1895BG . . . V-171, V-172, V-173	VG2831VN . . . V-298, V-300, V-302
VG1871CN . . . V-165, V-166, V-167	VG1895BL . . . V-171, V-172, V-173	VG2831WM V-303
VG1871CP . . . V-165, V-166, V-167	VG1895BN . . . V-171, V-172, V-173	VG2831WN . . . V-292, V-293, V-294, V-295, V-298, V-300, V-301, V-302
VG1875AD . . . V-168, V-169, V-170	VG1895CL . . . V-171, V-172, V-173	VG2831YN . . . V-292, V-293, V-294, V-295, V-298, V-300, V-301, V-302, V-303
VG1875AE . . . V-168, V-169, V-170	VG1895CN . . . V-171, V-172, V-173	VG7241CS V-227
VG1875AF . . . V-168, V-169, V-170	VG1895CP . . . V-171, V-172, V-173	VG7241CT . . . V-212, V-215, V-217, V-230, V-232
	VG2231TL . . . V-298, V-300	VG7241ES V-227
	VG2231TM . . . V-292, V-293, V-294, V-295, V-298, V-300, V-301, V-302, V-303	VG7241ET . . . V-212, V-215, V-217, V-230, V-232
	VG2231UL . . . V-298, V-300	VG7241GS V-227
	VG2231UM . . . V-292, V-293, V-294, V-295, V-298, V-300, V-301, V-302, V-303	VG7241GT . . . V-212, V-215, V-217, V-230, V-232

Note: Page numbers in *italics* denote pages where the product code number appears, but not as the main part.

Code Number Index

VG7241NT . . V-212, V-215, V-217, V-219, V-230, V-232, V-236	VG7251RT . . . V-213, V-232, V-234	VG7441LT . . V-215, V-217, V-230, V-232
VG7241PT . . V-212, V-215, V-217, V-219, V-230, V-232, V-236	VG7271CS V-227	VG7441NT . . V-215, V-217, V-219, V-230, V-232, V-236
VG7241RT . . V-212, V-219, V-230, V-232, V-236	VG7271CT . . . V-213, V-216, V-217, V-231, V-233	VG7441PT . . V-215, V-217, V-219, V-230, V-232, V-236
VG7241ST . . V-212, V-219, V-230, V-232, V-236	VG7271ES V-227	VG7441RT . . V-219, V-230, V-232, V-236
VG7243CT . . V-221, V-223, V-224, V-225, V-238, V-239, V-240	VG7271ET . . . V-213, V-216, V-217, V-231, V-233	VG7441ST . . V-219, V-230, V-232, V-236
VG7243ET . . V-221, V-223, V-224, V-225, V-238, V-239, V-240	VG7271GS V-227	VG7443CT . . V-223, V-224, V-226, V-238, V-239, V-240
VG7243GT . . V-221, V-223, V-224, V-225, V-238, V-239, V-240	VG7271GT . . . V-213, V-216, V-217, V-231, V-233	VG7443ET . . V-223, V-224, V-226, V-238, V-239, V-240
VG7243LT . . . V-221, V-223, V-224, V-225, V-238, V-239, V-240	VG7281CS V-227	VG7443GT . . V-223, V-224, V-226, V-238, V-239, V-240
VG7243NT . . V-221, V-223, V-224, V-225, V-238, V-239, V-240	VG7281CT . . . V-212, V-215, V-217, V-231, V-233	VG7443LT . . V-223, V-224, V-226, V-238, V-239, V-240
VG7243PT . . V-221, V-223, V-224, V-225, V-238, V-239, V-240	VG7281ES V-227	VG7443NT . . V-223, V-224, V-226, V-238, V-239, V-240
VG7243RM V-242	VG7281ET . . . V-212, V-215, V-217, V-231, V-233	VG7443PT . . V-223, V-224, V-226, V-238, V-239, V-240
VG7243RT . . V-221, V-225, V-240	VG7281GT . . . V-212, V-215, V-217, V-231, V-233	VG7443RM V-242
VG7243SM V-242	VG7281GS V-227	VG7443RT . . . V-226, V-240
VG7243ST . . V-221, V-225, V-240	VG7281GT . . . V-212, V-215, V-217, V-231, V-233	VG7443SM V-242
VG7251CS V-228	VG7281LS V-227	VG7443ST . . . V-226, V-240
VG7251CT . . V-213, V-232, V-234	VG7281LT . . . V-212, V-215, V-217, V-231, V-233	VG7451CS V-228
VG7251ES V-228	VG7281NT . . . V-212, V-215, V-217, V-231, V-233	VG7451CT . . . V-232, V-234
VG7251ET . . V-213, V-232, V-234	VG7281PT . . . V-212, V-216, V-217, V-231, V-233	VG7451ES V-228
VG7251GS V-228	VG7281RT . . . V-212, V-231, V-233	VG7451ET . . . V-232, V-234
VG7251GT . . V-213, V-232, V-234	VG7281ST . . . V-212, V-231, V-233	VG7451GS V-228
VG7251LS V-228	VG7291CS V-228	VG7451GT V-234
VG7251LT . . . V-213, V-232, V-234	VG7291CT . . . V-213, V-216, V-218, V-231, V-234	VG7471CS V-228
VG7251NT . . V-213, V-232, V-234	VG7291ES V-228	VG7471CT . . V-216, V-217, V-231, V-233
VG7251PT . . V-213, V-232, V-234	VG7291ET . . . V-213, V-216, V-218, V-231, V-234	VG7471ES V-228
	VG7291GS V-228	VG7471ET . . V-216, V-217, V-231, V-233
	VG7291GT . . . V-213, V-216, V-218, V-231, V-234	VG7471GS V-228
	VG7441CS V-227	VG7471GT . . V-216, V-217, V-231, V-233
	VG7441CT . . . V-215, V-217, V-230, V-232	VG7481CS V-227
	VG7441ES V-227	VG7481CT . . V-216, V-217, V-231, V-233
	VG7441ET . . . V-215, V-217, V-230, V-232	VG7481ES V-227
	VG7441GS V-227	VG7481ET . . V-216, V-217, V-231, V-233
	VG7441GT . . . V-215, V-217, V-230, V-232	VG7481GS V-227
	VG7441LS V-227	VG7481GT . . V-216, V-217, V-231, V-233

Note: Page numbers in *italics* denote pages where the product code number appears, but not as the main part.

Code Number Index

VG7481LS	V-227	VG7842GT . . .	V-212, V-215, V-217, V-230, V-233	VG7872ET . .	V-213, V-216, V-218, V-231, V-233
VG7481LT . . .	V-216, V-217, V-231, V-233	VG7842LS	V-227	VG7872GS	V-228
VG7481NT . .	V-216, V-217, V-231, V-233	VG7842LT . . .	V-212, V-215, V-217, V-230, V-233	VG7872GT . .	V-213, V-216, V-218, V-231, V-233
VG7481PT . .	V-216, V-217, V-231, V-233	VG7842NT . . .	V-212, V-215, V-217, V-219, V-230, V-233, V-236	VG7882CS	V-227
VG7481RT . . .	V-231, V-233	VG7842PT . . .	V-212, V-215, V-217, V-219, V-230, V-233, V-236	VG7882CT . .	V-213, V-216, V-217, V-231, V-233
VG7481ST . . .	V-231, V-233	VG7842ST . . .	V-212, V-219, V-230, V-233, V-236	VG7882ES	V-227
VG7491CS	V-228	VG7844CT . . .	V-221, V-223, V-224, V-225, V-226, V-238, V-239, V-240	VG7882ET . .	V-213, V-216, V-217, V-231, V-233
VG7491CT . .	V-216, V-218, V-231, V-234	VG7844ET . . .	V-221, V-223, V-224, V-225, V-226, V-238, V-239, V-240	VG7882GS	V-227
VG7491ES	V-228	VG7844GT . . .	V-221, V-223, V-224, V-225, V-226, V-238, V-239, V-240	VG7882GT . .	V-213, V-216, V-217, V-231, V-233
VG7491ET . .	V-216, V-218, V-231, V-234	VG7844LT . . .	V-221, V-223, V-224, V-225, V-226, V-238, V-239, V-240	VG7882LS	V-227
VG7491GS	V-228	VG7844NT . . .	V-221, V-223, V-224, V-225, V-226, V-238, V-239, V-240	VG7882LT . .	V-213, V-216, V-217, V-231, V-233
VG7491GT . .	V-216, V-218, V-231, V-234	VG7844PT . . .	V-221, V-223, V-224, V-225, V-226, V-238, V-239, V-240	VG7882NT . .	V-213, V-216, V-217, V-231, V-233
VG7551CS	V-228	VG7844RM	V-242	VG7882PT . .	V-213, V-216, V-217, V-231, V-233
VG7551CT . .	V-213, V-232, V-234	VG7844RT . . .	V-221, V-225, V-226, V-240	VG7882RT . .	V-213, V-231, V-233
VG7551ES	V-228	VG7844SM	V-242	VG7882ST . . .	V-231, V-233
VG7551ET . .	V-213, V-232, V-234	VG7844ST . . .	V-221, V-225, V-226, V-240	VG7892CS	V-228
VG7551GS	V-228	VG7872CS	V-228	VG7892CT . .	V-213, V-216, V-218, V-232, V-234
VG7551GT . .	V-213, V-232, V-234	VG7872CT . . .	V-213, V-216, V-218, V-231, V-233	VG7892ES	V-228
VG7551LS	V-228	VG7872ET . . .	V-213, V-216, V-218, V-231, V-233	VG7892ET . .	V-213, V-216, V-218, V-232, V-234
VG7551LT . . .	V-213, V-232, V-234	VG7872ES	V-228	VG7892GS	V-228
VG7551NT . .	V-213, V-232, V-234			VG7892GT . .	V-213, V-216, V-218, V-232, V-234
VG7551PT . .	V-213, V-232, V-234			VWD020HB	V-327
VG7551RT . .	V-213, V-232, V-234			VWD025HB	V-327
VG7842CS	V-227			VWD030HB	V-327
VG7842CT . .	V-212, V-215, V-217, V-230, V-233			VWD040LB	V-327
VG7842ES	V-227			VWN020HB . .	V-313, V-314
VG7842ET . .	V-212, V-215, V-217, V-230, V-233			VWN025HB . .	V-313, V-314
VG7842GS	V-227			VWN030HB . .	V-313, V-314
				VWN040HB . .	V-313, V-314
				VWN040LB	V-313
				VWN050HB	V-314
				VWN050LB . . .	V-313, V-314
				VWN060LB	V-314

Note: Page numbers in *italics* denote pages where the product code number appears, but not as the main part.

M9102-AGA-2S, -3S and M9104-xxA-2S, -3S Series Electric Non-Spring Return Actuators

Description

The M9102 and M9104 Series Actuators are direct-mount, non-spring return electric actuators that operate on AC 24 V or 100 to 240 VAC power. These motor-driven actuators provide floating control (AGA), floating control with automatic shutoff (IGA), proportional control with selectable 0-10 or 2-10 VDC (GGA), and line voltage power supply (IUA). The -2S models are equipped with plenum cables, and the -3S models are equipped with terminal blocks.

All models are compact in size and are easily installed on VAV boxes, Variable Air Volume and Temperature (VVT) two-position zone dampers with a round shaft up to 1/2 in. (13 mm) in diameter or a 3/8 in. (10 mm) square shaft.

The M9102 Series Electric Non-Spring Return Actuators provide a running torque of 18 lb-in (2 N·m), and the nominal travel time is 30 seconds at 60 Hz (36 seconds at 50 Hz) for 90° of rotation. The M9104 Series Electric Non-Spring Return Actuators provide a running torque of 35 lb-in (4 N·m), and the nominal travel time is 60 seconds at 60 Hz for 90° of rotation.

Refer to the *M9102-AGA-2S, -3S and M9104-xGA-2S, -3S Series Electric Non-Spring-Return Actuators Product Bulletin (LIT-1201742)* for important product application information.

Features

- Two Torques Available: 18 and 35 lb-in (2 and 4 N·m)
- Short 30-Second Travel Time Available
- 35 dBA Maximum Audible Noise Rating at 1 Meter
- Synchronous Drive (AGA, IGA, GGA models)
- 100,000 Cycle Rating
- Direct Shaft Mounting with Single-Screw Coupler
- Magnetic Clutch
- Manual Gear Release
- Plenum Cable or Screw Terminal Electric Connections
- Floating, Floating with Timeout, and Proportional 0(4) to 10 VDC Control Inputs Available
- Small, Compact Design

Applications

The M9102 and M9104 Series Electric Non-Spring Return Actuators are designed to position balancing, control, round, and zone dampers in HVAC systems. These electric actuators are also designed to position blades in a VAV box, or they can be used in VVT two-position zone applications.

Each actuator mounts directly to the surface in any convenient orientation using a single No. 10 standard sheet metal screw (included with the actuator). No additional linkages or couplers are required. Electrical connections on the actuator are clearly labeled to simplify installation.

Repair Information

If the M9102 or M9104 Series Electric Non-Spring Return Actuator fails to operate within its specifications, replace the unit. For a replacement electric actuator, contact the nearest Johnson Controls® representative.



M9102 Series Electric Non-Spring Return Actuator

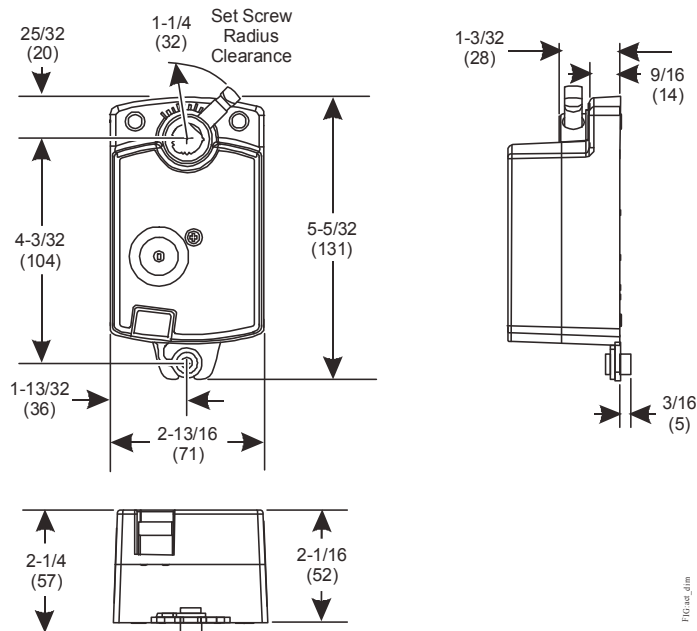

M9102/M9104 Series Electric Non-Spring Return Actuator Dimensions, in. (mm)

M9102-AGA-2S, -3S and M9104-xxA-2S, -3S Series Electric Non-Spring Return Actuators (Continued)

Selection Chart

Code Number	Control Type	Running Torque	Travel Time	Power Supply (VA rating)	Electrical Connections
M9102-AGA-2S	Floating	18 lb·in (2 N·m)	30 Seconds at 60 Hz 36 Seconds at 50 Hz	2.5	48 in. (1.2 m) UL 444 Type CMP Plenum Rated cable with 19 AWG (0.75 mm ²) conductors and .25 in. (6 mm) ferrule ends
M9102-AGA-3S	Floating	18 lb·in (2 N·m)	30 Seconds at 60 Hz 36 Seconds at 50 Hz	2.5	M3 Screw Terminals
M9104-AGA-2S	Floating	35 lb·in (4 N·m)	60 Seconds at 60 Hz 72 Seconds at 50 Hz	2.1	48 in. (1.2 m) UL 444 Type CMP Plenum Rated cable with 19 AWG (0.75 mm ²) conductors and .25 in. (6 mm) ferrule ends
M9104-AGA-3S	Floating	35 lb·in (4 N·m)	60 Seconds at 60 Hz 72 Seconds at 50 Hz	2.1	M3 Screw Terminals
M9104-IGA-2S	Floating or On/Off	35 lb·in (4 N·m)	60 Seconds at 60 Hz 72 Seconds at 50 Hz	3.0	48 in. (1.2 m) UL 444 Type CMP Plenum Rated cable with 19 AWG (0.75 mm ²) conductors and .25 in. (6 mm) ferrule ends
M9104-IGA-3S	Floating or On/Off	35 lb·in (4 N·m)	60 Seconds at 60 Hz 72 Seconds at 50 Hz	3.0	M3 Screw Terminals
M9104-GGA-2S	Proportional	35 lb·in (4 N·m)	60 Seconds at 60 Hz 72 Seconds at 50 Hz	2.9	48 in. (1.2 m) UL 444 Type CMP Plenum Rated cable with 19 AWG (0.75 mm ²) conductors and .25 in. (6 mm) ferrule ends
M9104-GGA-3S	Proportional	35 lb·in (4 N·m)	60 Seconds at 60 Hz 72 Seconds at 50 Hz	2.9	M3 Screw Terminals
M9104-IUA-2S	Floating or On/Off	35 lb·in (4 N·m)	60 Seconds at 50/60 Hz	7.5 (0.07A)	48 in. (1.2 m) UL 444 Type CMP Plenum Rated cable with 18 AWG (1.02 mm ²) conductors for 3/8 in. (10 mm) flexible metal conduit

Accessories

Code Number	Description
DMPR-KC003 ¹	7 in. (178 mm) blade pin extension without bracket for Johnson Controls direct-mount damper applications
DMPR-KR003 ¹	Sleeve pin kit for Johnson Controls round dampers with a 5/16 in. (8 mm) diameter shaft
M9000-200	Commissioning tool that provides a control signal to drive 24 V on/off, floating, proportional, and/or resistive electric actuators
M9104-100	Connector for 3/8 in. (10 mm) flexible metal conduit

1. Furnished with the damper and may be ordered separately.

M9102-AGA-2S, -3S and M9104-xxA-2S, -3S Series Electric Non-Spring Return Actuators (Continued)

Technical Specifications

Power Requirements	M910x-AGA-xS	AC 24 V +25%/-20% at 50/60 Hz, 2.1 VA, Class 2, Safety Extra-Low Voltage (SELV)
	M9104-IGA-xS	AC 24 V +25%/-20% at 50/60 Hz, 3.0 VA, Class 2, SELV
	M9104-GGA-xS	AC 24 V +25%/-20% at 50/60 Hz, 2.9 VA, Class 2, SELV
	M9104-IUA-2S	AC 100 to 240 V (-15%+10%) at 60 Hz, 0.07A, and 7.5 VA Supply
Control Type	M910x-AGA-xS	Floating Control without Timeout
	M9104-IGA-xS	Floating or On/Off Control with Timeout
	M9104-GGA-xS	Proportional Control
	M9104-IUA-2S	Floating or On/Off Control with Timeout
Input Signal	M910x-AGA-xS	AC 24 V +25%/-20% at 50/60 Hz, Class 2, SELV without Timeout
	M9104-IGA-xS	AC 24 V +25%/-20% at 50/60 Hz, Class 2, SELV with Timeout
	M9104-GGA-xS	0(2) to 10 VDC or 0(4) to 20 mA with Field-furnished 500 ohm Resistor
	M9104-IUA-2S	AC 100 to 240 V (-15%+10%) at 50/60 Hz, and 7.5 VA Supply
Feedback Signal	M9104-GGA-2S	0 VDC to 10 VDC or 2 VDC to 10 VDC for 90° (10 VDC at 1 mA) Corresponds to Input Signal Span Selection
Motor Input Impedance		200 ohms Nominal
Running Torque	M9102 Series	18 lb·in (2 N·m)
	M9104 Series	35 lb·in (4 N·m)
Travel Time	M9102 Series	30 Seconds at 60 Hz (36 Seconds at 50 Hz) for 90° of Rotation
	M9104 Series	60 Seconds at 60 Hz (72 Seconds at 50 Hz) for 90° of Rotation
	M9104 (IUA)	60 Seconds at 50/60 Hz for 90° of Rotation
Rotation Range		93° ±3°, CW or CCW
Cycles		100,000 Full Stroke Cycles; 2,500,00 Repositions at Rated Running Torque
Audible Noise Rating		35 dBA at 39-13/32 in. (1 m) Maximum
Electrical Connections	M9102-AGA-2S M9104-xxA-2S	48 in. (1.02 m) UL 444 Type CMP Plenum Rated Cable with 18 AWG (1.02 mm) Conductors and 1/4 in. (6 mm) Ferrule Ends
	M9102-AGA-3S M9104-xGA-3S	M3 Screw Terminals
	M9104-IUA-2S	48 in. (1.2 mm) with 18 AWG (1.02 mm ²) Conductors and Connector for 3/8 in. (10 mm) Flexible Metal Conduit
		Up to 1/2 in. (13 mm) Diameter Round Damper Shaft or 3/8 in. (10 mm) Square Damper Shaft
Mechanical Connections	M9102-AGA-2S M9104-xxA-2S	NEMA 1, IP42
	M9102-AGA-3S M9104-xxA-3S	NEMA 1, IP40
Enclosure	Operating	-4°F to 140°F (-20°C to 60°C); 90% RH Maximum, Noncondensing
	Storage	-20°F to 150°F (-29°C to 66°C); 90% RH Maximum, Noncondensing
Ambient Conditions	United States	UL Listed, CCN XAPX, File 27734 Plenum rated, UL2043, suitable for use in other environmental spaces (plenums) in accordance with section 300.22.(c) of the National Electrical Code
	Canada	cUL Listed, CCN XAPX7, File 27734 Plenum Rated Per CSA 22.2 No. 236/UL 1995, Heating and Cooling Equipment
	Europe	Johnson Controls declares that this product is in compliance with the essential requirements and other relevant provisions of the EMC Directive 2004/108/EC and the Low Voltage Directive 2006/95/EC.
	Australia and New Zealand	C-Tick Mark, Australia/NZ Emissions Compliant
Shipping Weight		1.0 lb (0.5 kg)

M9104-AGx-2N Electric Non-Spring-Return Actuators

Description

The M9104-AGA-2N synchronous motor-driven actuator provides floating (three-wire) control and is easily installed on a VAV box or a small- to medium-sized damper with a round shaft up to 1/2 in. (13 mm) in diameter or a 3/8 in. (10 mm) square shaft. This compact, non-spring-return actuator has a 35 lb-in (4 N·m) running torque and 40 lb-in (4.5 N·m) minimum stall torque in a compact, easy-to-install package. It has a nominal 90-second travel time for 90° of rotation at 60 Hz (108 seconds at 50 Hz) for 90° of rotation.

The M9104-AGS-2N Actuator/Transmitter combines an M9104-AGA-2N with a pre-wired DPT-2015 Differential Pressure Transmitter that has a 0 in. to 1.5 in. water column (W.C.) (0 Pa to 374 Pa) differential pressure range.

Refer to the *M9104-AGx-2N Electric Non-Spring-Return Actuators Product Bulletin (LIT-2681121)* for important product application information.

Features

- 30 dBA rating meets audible noise requirements for open ceilings
- synchronous drive provides constant rotation time that is independent of load
- 100,000 cycle rating extends actuator life due to improved technology
- direct shaft mount with single-screw coupler simplifies installation and provides 3-point shaft gripping
- magnetic clutch provides torque protection for the actuator gear train and damper

- adjustable rotation stops allow application versatility with 30° to 90° clockwise (CW) or counterclockwise (CCW) rotation
- manual gear release simplifies setup and field adjustments
- screw terminal connection makes wiring easy

Applications

The M9104-AGx-2N actuator is used to position balancing, control, round, and zone dampers in typical HVAC applications. It is also used to position the blades in a VAV box.

The actuator mounts directly to the surface of a VAV box, round damper, or small rectangular damper with a single No. 10 self-drilling sheet metal screw (included). There are no additional linkages or couplers required. Clearly labeled electrical terminals simplify installation. Refer to the damper or VAV box manufacturer's information to select the proper timing for the actuator.

When combined with a VAV controller, the actuator provides reliable, integrated damper control. Refer to the *M9104-AGx-2N Series Electric Non-Spring-Return Actuators Application Note (LIT-2681110)* for various configurations with and without the DPT-2015 differential pressure transmitter.

For more information, refer to the *M9104-AGx-2N Electric Non-Spring-Return Actuators Installation Instructions (Part No. 34-636-631)*.



M9104-AGA-2N
Electric Non-Spring-Return Actuator

Repair Information

If the M9104-AGx-2N Electric Actuator fails to operate within its specifications, replace the unit. For a replacement actuator, contact the nearest Johnson Controls® representative.

Selection Chart

Code Number	Control Type	Torque / Timing / Voltage	Auxiliary Switches	Comments
M9104-AGA-2N	Floating	35 lb-in (4 N·m) 90 seconds at 60 Hz AC 24 V 50/60 Hz	None	Actuator only
M9104-AGS-2N		35 lb-in (4 N·m) 90 seconds at 60 Hz AC 24 V 50/60 Hz		Actuator includes a DPT-2015 and CBL-2000-1

Accessories

Code Number	Description
CBL-2000-1	20 in. (0.5 m) wiring harness (Underwriters Laboratories, Inc.® [UL] accepted for plenum use) supplied with the M9104-AGS-2N and may be ordered separately; connects the M9104 and DPT-2015 to the VAV controller
CBL-2000-2	20 in. (0.5 m) plenum rated wiring harness
CBL-2000-3	72 in. (1.8 m) plenum rated wiring harness
DPT-2015-0	0 in. to 1.5 in. W.C. (0 Pa to 374 Pa) differential pressure transmitter supplied with the M9104-AGS-2N and may be ordered separately
DMPR-KC003	Blade pin extension without bracket supplied with CD-1300 dampers and may be ordered separately

M9104-AGx-2N Electric Non-Spring-Return Actuators (Continued)

Dimensions

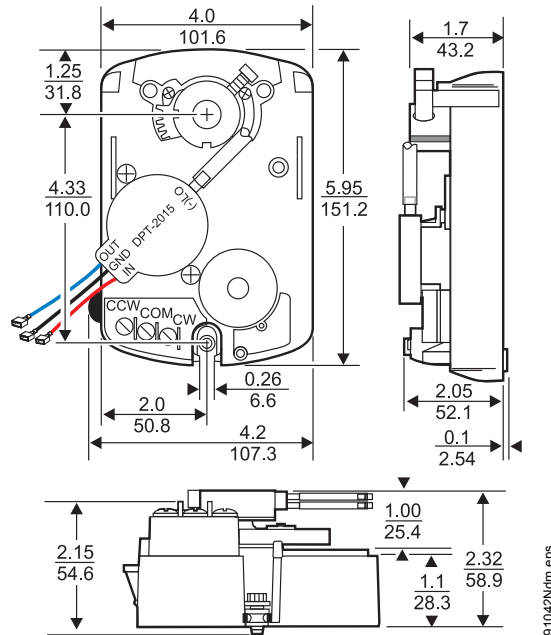

Note: All dimensions are nominal unless otherwise specified.

Dimensions, in. (mm)

Technical Specifications

M9104-AGx-2N Electric Non-Spring-Return Actuators		
Power Requirements	M9104-AGx-2N: 20 VAC to 30 VAC at 50 Hz or 60 Hz, 2.1 VA maximum, Class 2 DPT-2015: 15 VDC (14.5 VDC to 17 VDC, unregulated); 15 mA maximum	
Input Signal	M9104-AGx-2N: 24 VAC (20 VAC to 30 VAC) at 50 Hz or 60 Hz	
Motor Input Impedance	M9104-AGx-2N: 250 ohms, nominal	
DPT-2015-0	Pressure range: 0 in. to 1.5 in. W.C. (0 Pa to 374 Pa) Over pressure limit: 15 in. W.C. (3.74 kPa) Output voltage: 0.5 VDC to 4.5 VDC with 25,000 ohm minimum load impedance	
Audible Noise Rating	30 dBA maximum at 1 m	
Mechanical Output	Running torque: 35 lb·in (4 N·m)	
Rotation Range	Adjustable from 30° to 90°, CW or CCW	
Rotation Time	Nominal 90 seconds at 60 Hz for 90°; nominal 108 seconds at 50 Hz for 90°	
Cycles	100,000 full cycles, 2,500,000 repositions rated at 35 lb·in (4 N·m)	
Electrical Connection	No. 6-32 screw terminals on the M9104 actuator; 1/4 in. spade terminals on the DPT-2015	
Pressure Connection	6 in. (152 mm) length of silicone tubing with barbed fittings for 1/4 in. (6.35 mm) O.D. tubing	
Enclosure	NEMA 1, IP30	
Ambient Operating Conditions	M9104-AGA-2N: 32°F to 125°F (0°C to 52°C); 90% RH maximum, noncondensing M9104-AGS-2N: 32°F to 125°F (0°C to 52°C); 90% RH maximum, noncondensing 60°F to 100°F (16°C to 38°C); 90% RH maximum, noncondensing for DPT rated accuracy (Refer to the <i>DPT-2015 Differential Pressure Transmitter for VAV Box Applications Installation Instructions</i> [Part No. 24-7547-18].)	
Ambient Storage Conditions	-20°F to 150°F (-29°C to 66°C); 90% RH maximum, noncondensing	
Dimensions (H x W x D)	M9104-AGA-2N: 5.95 in. x 4.2 in. x 2.15 in. (151.2 mm x 107.3 mm x 54.6 mm) M9104-AGS-2N: 5.95 in. x 4.2 in. x 2.32 in. (151.2 mm x 107.3 mm x 58.9 mm) with the DPT-2015	
Shipping Weight	M9104-AGA-2N: 2.0 lb (0.91 kg) M9104-AGS-2N: 2.2 lb (0.99 kg) with the DPT-2015	
Compliance	United States	UL 873 Listed, File E27734, CCN XAPX
	Canada	CSA Certified C22.2 No. 139, File LR85083, Class 3221 02
	Europe	CE Mark - Johnson Controls declares that this product is in compliance with the essential requirements and other relevant provisions of the EMC Directive 2004/108/EC.

The performance specifications are nominal and conform to acceptable industry standards. For applications at conditions beyond these specifications, consult the local Johnson Controls office. Johnson Controls shall not be liable for damages resulting from misapplication or misuse of its products. © 2019 Johnson Controls. www.johnsoncontrols.com

M9106-xGx-2 Series Electric Non-Spring-Return Actuators

Description

The M9106-xGx-2 Series direct-mount electric actuators operate on AC 24 V power and are available for use with on/off, floating, or proportional controllers. These non-spring-return actuators are easily installed on a VAV box, a damper with a round shaft up to 1/2 in. (13 mm) in diameter, or a square shaft up to 3/8 in. (10 mm). The M9106 with an M9000-520 linkage can also be used to position VG1000 Series 1/2 in. (DN15) to 1-1/2 in. (DN40) ball valves.

The M9106 Series models have 53 lb-in (6 N·m) running torque. These actuators have a nominal 60-second travel time for 90° of rotation at 60 Hz (72 seconds at 50 Hz) with a load-independent rotation time.

The M9106-xGC-2 models are available with integral auxiliary switches to perform switching functions at any angle within the selected rotation range. The -GGx models feature DC 0(2) to 10 V position feedback, and the -AGF models provide 10,000 ohm position feedback.

Features

- simple direct coupling reduces installation and commissioning time and improves reliability by eliminating damper linkages; single screw coupling provides three-point shaft gripping
- designed for zone damper and ball valve actuator applications
- small, compact design allows installation in tight-fitting locations
- on/off, floating, and proportional control inputs
- 60-second running time at 60 Hz
- long life brushless synchronous drive motor technology provides constant running time independent of load
- robust 53 lb-in (6 N·m) torque rating

- whisper quiet 35 dBA noise rating
- magnetic clutch provides over torque protection over the entire range of rotation
- -4°F to 125°F (-20°C to 52 °C) ambient temperature rating
- 100,000 full stroke cycle, 2,500,000 reposition rating
- manual gear release simplifies setup and field adjustments
- 1/2 in. NPT threaded conduit opening meets electrical code requirements and allows the use of flexible armored cable
- position feedback (-GGx models) provides simple, closed-loop control with accurate position sensing
- adjustable rotation stops allow application versatility with 30 to 90° clockwise or counterclockwise rotation

Applications

The M9106 actuators are used to position balancing, control, round, and zone dampers in typical HVAC applications. The M9106 can also be used with an M9000-520 linkage to control 1/2 in. (DN15) to 1-1/2 in. (DN40) VG1000 Series ball valves. The M9106 Series actuator mounts directly on the duct surface, round damper, or small rectangular damper with an anti-rotation bracket and two sheet metal screws (included). Additional linkages or couplers are not required.

Refer to the damper or VAV box manufacturer's information to select the proper timing for the actuator. Refer to the appropriate application note for specific wiring diagrams and information.



M9106-xGx-2 Series Electric Non-Spring-Return Actuator

Refer to the *M9106-xGx-2 Electric Non-Spring-Return Actuators Product Bulletin (LIT-2681123)* or the *M9106-xGx-2 Electric Non-Spring-Return Actuators Installation Instructions (Part No. 34-636-1085)* for important product application information.

Repair Information

If the M9106-xGx-2 Series Electric Actuator fails to operate within its specifications, replace the unit. For a replacement actuator, contact the nearest Johnson Controls® representative.

Selection Chart

Code Number	Control Type	Torque / Timing / Voltage	Auxiliary Switches	Comments
M9106-AGA-2 ¹	Floating	53 lb-in (6 N·m) 60 seconds at 60 Hz AC 24 V 50/60 Hz	None	
M9106-AGC-2 ¹			2-SPDT	
M9106-AGF-2 ¹	Floating with resistive feedback		None	10,000 ohm feedback pot
M9106-GGA-2	DC 0(2) to 10 V DC 0(4) to mA proportional		None	DC 0(2) to 10 V feedback
M9106-GGC-2		2-SPDT		
M9106-IGA-2	On/off / floating with timeout		None	Adjustable timing 1, 1.5, 2, 5.5, or 11 minutes
M9106-IGC-2		2-SPDT		

1. To avoid excessive wear or dive time on the motor for the -AGx models, use a controller and/or software that provides a time-out function to remove the signal at the end of rotation (stall). The -GGx and -IGx models have an auto shutoff to avoid excessive wear or drive time on the motor.

M9106-xGx-2 Series Electric Non-Spring-Return Actuators (Continued)

Accessories

Code Number	Description
CBL-2000-1	20 in. (0.5 m) wiring harness, UL accepted for plenum use, connects the M9106 and DPT-2015 to the VAV controller
CBL-2000-2	20 in. (0.5 m) plenum rated wiring harness
CBL-2000-3	72 in. (1.8 m) plenum rated wiring harness
DPT-2015-0	0 in. to 1.5 in. W.C. (0 Pa to 374 Pa) differential pressure transmitter
DMPR-KC003	Square head blade pin extension without bracket supplied with Johnson Controls CD-1300 dampers and may be ordered separately for all direct-mount applications
DMPR-KC010	Adjustable blade position indicator switch kit with total switching load limited to 2,000 VA for the following applications: Pilot duty: AC 24 V, 50 VA; AC 125/250/277 V, 125 VA Motor load: AC 125/250/277 V, 1/3 hp Resistive load: AC 125 V, 11 A; AC 250 V, 8 A; AC 277 V, 7 A (all maximum values)
DMPR-KC011	Hex head blade pin extension without bracket
DMPR-KC012	Hex head blade pin extension with bracket
DMPR-KC213	Damper jackshaft 1/2 in. diameter, 1 panel
DMPR-KC214	Damper jackshaft 1/2 in. diameter, 2 panel
M9000-105	Pluggable 3-terminal block
M9000-106	Pluggable 4-terminal block
M9000-160	Replacement anti-rotation bracket for M9106 Series actuators
M9000-520	Valve linkage kit for field mounting an M9106 Series actuator to a 1/2 in. (DN15) to 1-1/2 in. (DN40) VG1000 Series ball valve

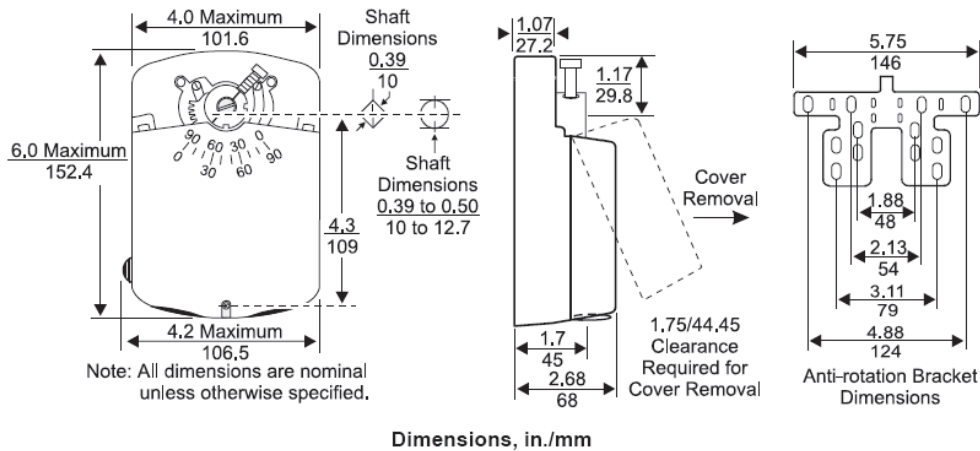

M9106-xGx-2 Series Electric Non-Spring-Return Actuators (Continued)

Technical Specifications

M9106-xGx-2 Series Electric Non-Spring-Return Actuators		
Power Requirement	AGx: AC 20-30 V at 50/60 Hz, 2.5 VA supply, Class 2 IGx: AC 20-30 V at 50/60 Hz, 2.8 VA supply, Class 2 GGx: AC 20-30 V at 50/60 Hz, 3.2 VA supply, Class 2	
Control Type	AGx: floating IGx: on/off, floating GGx: DC 0(2) to 10 V or DC 0(4) to 20 mA proportional	
Input Signal	AGx and IGx: AC 20 to 30 V at 50/60 Hz GGx: DC 0 to 10 V or DC 0(4) to 20 mA	
Input Signal Adjustments:	AGx and IGx: CW and COM Terminals, CW rotation; CCW and COM terminals, CCW rotation GGx (voltage input or current input): Jumper selectable: DC 0(2) to 10 V or DC 0(4) to 20 mA Factory setting: DC 0 to 10 V, CW rotation with signal increase Action is jumper selectable direct (CW) or reverse (CCW) with signal increase.	
Input Impedance	AGx: 200 ohms, nominal IGx: 160 ohms, nominal GGx: voltage input, 150,000 ohms; current input, 500 ohms	
Feedback Signal	AGF: 10,000 ohm potentiometer, 1 W GGx: DC 0 to 10 V or DC 2 to 10 V for 90° (1 mA); Corresponds to input signal span selection	
Auxiliary Switch Rating	xGC: two single-pole, double-throw (SPDT) switches rated at AC 24 V, 1.5 A inductive, 3.0 A resistive, 35 VA maximum per switch, Class 2	
Torque Rating	1, 1.5, and 2 minute settings: 53 lb·in (6 N·m) 5.5 and 11 minute settings: 35 lb·in (4 N·m)	
Cycle Life	100,000 full cycles; 2,500,000 repositions rated at 53 lb·in (6 N·m)	
Audible Noise Rating	35 dBA maximum at 39.4 in. (1 m)	
Rotation Range	Adjustable from 30° to 90°, CW or CCW	
Rotation Time	IGx: adjustable with switch settings (factory set for 1 minute) 60, 90, 120, 330, or 660 seconds (1, 1.5, 2, 5.5 or 11 minutes) at 60 Hz and 72, 108, 144, 396, or 792 seconds at 50 Hz All other models: nominal 60 seconds at 60 Hz and 72 seconds at 50 Hz for 90°	
Electrical Connection	1/4 in. spade terminals (to order optional pluggable terminal blocks, see Accessories)	
Mechanical Connection	3/8 in. to 1/2 in. (10 mm to 12.7 mm) round shaft or 3/8 in. (10 mm) square shaft	
Enclosure Rating	NEMA 2, IP32	
Ambient Operating Rating	-4°F to 125°F (-20°C to 52°C); 90% RH maximum, noncondensing	
Ambient Storage Rating	IGx: -40°F to 186°F (-40°C to 86°C); 90% RH maximum, noncondensing All other models: -40°F to 176°F (-40°C to 80°C); 90% RH maximum, noncondensing	
Shipping Weight	2.4 lb (1.08 kg)	
Compliance 	United States	UL 873 Listed, File E27734, CCN XAPX
	Canada	CSA C22.2 No. 139 Certified, File LR85083, Class 3221 02
	Europe	CE Mark - Johnson Controls declares that this product is in compliance with the essential requirements and other relevant provisions of the EMC Directive 2004/108/EC.

The performance specifications are nominal and conform to acceptable industry standards. For applications at conditions beyond these specifications, consult the local Johnson Controls office. Johnson Controls shall not be liable for damages resulting from misapplication or misuse of its products. © 2019 Johnson Controls. www.johnsoncontrols.com

M9106-AGx-2N0x Series Electric Non-Spring-Return Actuators

Description

The M9106-AGA-2N0x synchronous motor-driven actuators provide floating (3-wire) control and are easily installed on a VAV box. They may also be installed on a small- to medium-sized damper with a round shaft up to 1/2 in. (13 mm) in diameter or a 3/8 in. (10 mm) square shaft.

These compact, non-spring-return actuators have 53 lb-in (6 N·m) running torque in a compact easy-to-install package. The actuators are available with either a nominal 60-second travel time at 60 Hz (72 seconds at 50 Hz) or a nominal 120-second travel time at 60 Hz (144 seconds at 50 Hz) for 90° of rotation.

The M9106-AGS-2N02 Actuator/Transmitter combines an M9106-AGA-2N02 with a prewired DPT-2015 Differential Pressure Transmitter that has a 0 in. to 1.5 in. W.C. (0 Pa to 374 Pa) differential pressure range.

Features

- simple direct coupling reduces installation and commissioning time by eliminating damper linkages
- whisper quiet 35 dBA rating meets audible requirements for open ceilings
- long life brushless synchronous drive
- motor technology provides constant rotation time independent of load
- 100,000 cycle rating, 2,500,000 repositions
- direct shaft mount with single-screw coupler simplifies installation and provides 3-point shaft gripping
- magnetic clutch provides torque protection for the actuator gear train and damper
- manual gear release simplifies setup and field adjustments

Applications

The actuators are used to position balancing, control, round, and zone dampers in typical HVAC applications. They are also used to position the blades in a VAV box. The actuators mount directly to the surface of a VAV box, round damper, or small rectangular damper with a single No. 10 self-drilling sheet metal screw (included). There are no additional linkages or couplers required. Clearly labeled electrical terminals simplify installation. Refer to the damper or VAV box manufacturer's information to select the proper timing for the actuator.

Note: The damper rotation time must be defined at the controller, and the damper point definition must match the rotation time of the actuator.

When combined with a VAV controller, the actuator provides reliable integrated damper control. Refer to the *M9106-AGx-2N0x Series Electric Non-Spring-Return Actuators Application Note (LIT-2681116)* for various configurations with and without the DPT-2015 Differential Pressure Transmitter.

Refer to the *M9106-AGx-2N0x Electric Non-Spring-Return Actuators Product Bulletin (LIT-2681126)* or the *M9106-AGx-2N0x Electric Non-Spring-Return Actuators Installation Instructions (Part No. 34-636-1077)* for important product application information.



M9106-AGS-2N0x Series Electric Non-Spring-Return Actuator

Repair Information

If the M9106-AGx-2N0x Series Electric Actuator fails to operate within its specifications, replace the unit. For a replacement actuator, contact the nearest Johnson Controls® representative.

Selection Chart

Code Number	Control Type	Torque / Timing / Voltage	Auxiliary Switches	Comments
M9106-AGA-2N01	Floating	53 lb·in (6 Nm) 60 seconds at 60 Hz AC 24 V 50/60 Hz	None	Actuator only
M9106-AGA-2N02		53 lb·in (6 Nm) 120 seconds at 60 Hz AC 24 V 50/60 Hz		
M9106-AGS-2N02		53 lb·in (6 Nm) 120 seconds at 60 Hz AC 24 V 50/60 Hz		Actuator includes a DPT-2015 and CBL-2000-1

M9106-AGx-2N0x Series Electric Non-Spring-Return Actuators (Continued)

Accessories

Code Number	Description
CBL-2000-1	20 in. (0.5 m) wiring harness, UL accepted for plenum use, supplied with the M9106-AGS-2N02 and may be ordered separately; connects the M9106 and DPT-2015 to the VAV controller
CBL-2000-2	20 in. (0.5 m) plenum rated wiring harness; Underwriters Laboratories, Inc.® (UL) accepted for plenum use; connects the M9101 and DPT-2015-0 to the VAV controller
CBL-2000-3	72 in. (1.8 m) plenum rated wiring harness
DPT-2015-0	0 in. to 1.5 in. W.C. (0 Pa to 374 Pa) differential pressure transmitter
DMPR-KC003	Blade pin extension without bracket supplied with Johnson Controls CD-1300 dampers and may be ordered separately for all direct-mount applications
DMPR-KC011	Hex head blade pin extension without bracket
DMPR-KC012	Hex head blade pin extension with bracket
M9000-200	Commissioning tool provides a control signal to drive on/off, floating, proportional, or resistive actuators

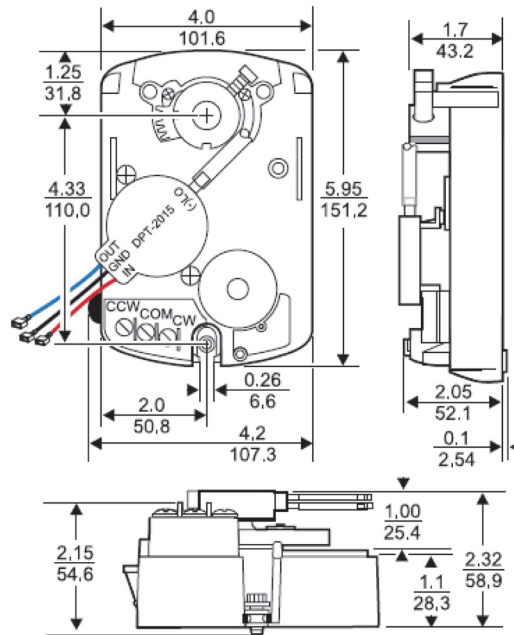

Dimensions, in. (mm)

M9106-AGx-2N0x Series Electric Non-Spring-Return Actuators (Continued)

Technical Specifications

M9106-AGx-2N0x Series Electric Non-Spring-Return Actuators	
Power Requirement	M9106-AGA-2N01: AC 20...30 V at 50/60 Hz, 2.5 VA supply, Class 2 M9106-AGx-2N02: AC 20...30 V at 50/60 Hz, 2.1 VA supply, Class 2 DPT-2015: DC 15 V (DC 14.5...17 V) unregulated; 15 mA, maximum
Control Type	Floating
Input Signal	M9106-AGx-2N0x: 24 V (AC 20...30 V) at 50 or 60 Hz
DPT 2015-0	Pressure range: 0 in. to 1.5 in. W.C. (0 Pa to 374 Pa) Over pressure limit: 15 in. W.C. (3.74 kPa) Output voltage: 0.5 VDC to 4.5 VDC with 25,000 ohm minimum load impedance
Input Impedance	M9106-AGA-2N01: 200 ohms, nominal M9106-AGx-2N02: 250 ohms, nominal
Feedback Signal	N/A
Auxiliary Switch Rating	N/A
Torque Rating	53 lb·in (6 N·m)
Cycle Life	100,000 full cycles; 2,500,000 repositions rated at 53 lb·in (6 N·m)
Audible Noise Rating	35 dBA maximum at 39.4 in. (1 m)
Rotation Range	Adjustable from 30° to 90°, CW or CCW
Rotation Time	M9106-AGx-2N01: nominal 60 seconds at 60 Hz and 72 seconds at 50 Hz for 90° M9106-AGS-2N02: nominal 120 seconds at 60 Hz and 144 seconds at 50 Hz for 90°
Electrical Connection	No. 6-32 screw terminals
Mechanical Connection	3/8 in. to 1/2 in. (10 mm to 12.7 mm) round shaft or 3/8 in. (10 mm) square shaft
Enclosure Rating	NEMA1, IP30
Ambient Operating Rating	M9106-AGA-2N0x: 32°F to 125°F (0°C to 52°C); 90% RH maximum, noncondensing M9106-AGS-2N02: 32°F to 125°F (0°C to 52°C); 90% RH maximum, noncondensing 60°F to 100°F (16°C to 38°C); 90% RH maximum, noncondensing for DPT rated accuracy (Refer to the <i>DPT-2015 Differential Pressure Transmitter for VAV Box Applications Installation Instructions [Part No. 24-7547-18].</i>)
Ambient Storage Rating	-20°F to 150°F (-29°C to 66°C); 90% RH maximum, noncondensing
Shipping Weight	M9106-AGA-2N0x: 2.0 lb (0.91 kg) M9106-AGS-2N02: 2.2 lb (0.99 kg) with the DPT-2015
Agency Compliance	UL 873 Listed, File E27734, CCN XAPX CSA C22.2 No. 139 Certified, File LR85083, Class 3221 02 CE Mark, EMC Directive 2004/108/EC

M9109-xGx-2 Series Electric Non-Spring-Return Actuators

Description

The M9109 Series direct-mount electric actuators operate on AC 24 V power and are available for use with floating or proportional controllers. These non-spring-return actuators are easily installed on a VAV box, a round damper shaft up to 1/2 in. (13 mm) in diameter, or a 3/8 in. (10 mm) square shaft. The M9109 with an M9000-520 linkage can be used to control 2 in. (DN50) VG1000 Series ball valves.

The M9109 models have 80 lb·in (9 N·m) running torque. They have a nominal 60-second travel time for 90° of rotation at 60 Hz (72 seconds at 50 Hz) with a load-independent rotation time. The M9109-xGC-2 models are available with integral auxiliary switches to perform switching functions at any angle within the selected rotation range.

Refer to the *M9109 Series Electric Non-Spring-Return Actuators Product Bulletin (LIT-120112)* for important product application information.

Applications

The M9109 is used to position balancing, control, round, and zone dampers in typical HVAC applications. It can also be used with an M9000-520 linkage to control VG1000 Series ball valves. The M9109 mounts directly on the duct surface, round damper, or small rectangular damper with an anti-rotation bracket and two sheet metal screws (included). Additional linkages or couplers are not required. For more information, refer to the *M9109 Series Electric Non-Spring-Return Actuators Installation Instructions (Part No. 34-636-1190)*.

Features

- simple direct coupling reduces installation and commissioning time and improves reliability by eliminating damper linkages
- Single screw coupling provides three-point shaft gripping
- designed for zone damper and ball valve actuator applications
- small, compact design allows installation in tight-fitting locations
- designed for zone damper and ball valve actuator applications
- floating and proportional control inputs
- 60-second running time at 60 Hz
- long life brushless synchronous drive motor technology provides constant running time independent of load
- robust 80 lb·in (9 N·m) torque rating
- whisper quiet 35 dBA noise rating
- magnetic clutch provides over torque protection over the entire range of rotation
- -4°F to 125°F (-20°C to 52°C) ambient temperature rating
- 100,000 full stroke cycle, 2,500,000 reposition rating
- manual gear release simplifies setup and field adjustments
- 1/2 in. NPT threaded conduit opening meets electrical code requirements and allows the use of flexible armored cable
- position feedback (-GGX models) provides simple, closed-loop control with accurate position sensing
- adjustable rotation stops allow application versatility with 30 to 90° clockwise or counterclockwise rotation



M9109-xGx-2 Series Electric Non-Spring-Return Actuator

Repair Information

If the M9109-xGx-2 Series Electric Actuator fails to operate within its specifications, replace the unit. For a replacement actuator, contact the nearest Johnson Controls® representative.

Selection Chart

Code Number	Control Type	Torque / Timing / Voltage	Auxiliary Switches	Comments	
M9109-AGA-2 ¹	Floating	80 lb·in (9 N·m) 60 seconds at 60 Hz AC 24 V 50/60 Hz	None		
M9109-AGC-2 ¹			2-SPDT		
M9109-GGA-2	DC 0(2) to 10 V	None	None		DC 0(2) to 10 V feedback
M9109-GGC-2	DC 0(4) to 20 mA proportional		2-SPDT		

1. To avoid excessive wear or drive time on the motor for the -AGx models, use a controller and/or software that provides a time-out function to remove the signal at the end of rotation (stall). The -GGx models have an auto shutoff to avoid excessive wear or drive time on the motor.

M9109-xGx-2 Series Electric Non-Spring-Return Actuators (Continued)

Accessories

Code Number	Description
DMPR-KC003	Square head blade pin extension without bracket
DMPR-KC010	Adjustable blade position indicator switch kit with total switching load limited to 2,000 VA for the following applications: Pilot duty: AC 24 V, 50 VA; AC 125/250/277 V, 125 VA Motor load: AC 125/250/277 V, 1/3 hp Resistive load: AC 125 V, 11 A; AC 250 V, 8 A; AC 277 V, 7 A (all maximum values)
DMPR-KC011	Hex head blade pin extension without bracket
DMPR-KC012	Hex head blade pin extension with bracket
DMPR-KC213	Damper jackshaft 1/2 in. diameter, 1 panel
DMPR-KC214	Damper jackshaft 1/2 in. diameter, 2 panel
M9000-105	Pluggable 3-terminal block
M9000-106	Pluggable 4-terminal block
M9000-160	Replacement anti-rotation bracket for M9106 and M9109 Series actuators
M9000-520	Valve linkage kit for field mounting an M9109 actuator to a 2 in. (DN50) VG1000 Series ball valve

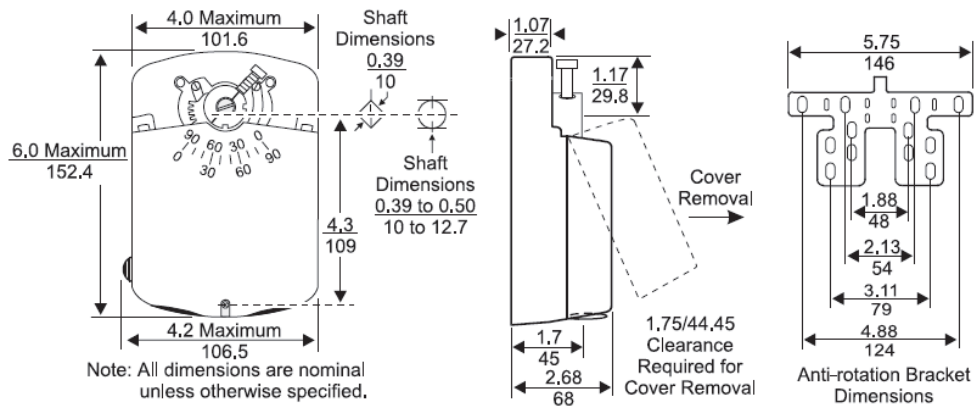

Dimensions, in./mm

M9109-xGx-2 Series Electric Non-Spring-Return Actuators (Continued)

Technical Specifications

M9109-xGx-2 Series Electric Non-Spring-Return Actuators		
Power Requirement	AGx: AC 20 to 30 V at 50/60 Hz, 2.5 VA supply, Class 2 GGx: AC 20 to 30 V at 50/60 Hz, 3.2 VA supply, Class 2	
Control Type	AGx: floating GGx: DC 0(2) to 10 V or DC 0(4) to 20 mA proportional	
Input Signal	AGx: AC 20 to 30 V at 50/60 Hz GGx: DC 0(2) to 10 V or DC 0(4) to 20 mA	
Input Signal Adjustments:	AGx: CW and COM terminals, CW rotation; CCW and COM terminals, CCW rotation GGx (voltage input or current input): Jumper selectable: DC 0(2) to 10 V or DC 0(4) to 20 mA Factory setting: DC 0 to 10 V, CW rotation with signal increase Action is jumper selectable direct (CW) or reverse (CCW) with signal increase.	
Input Impedance	AGx: 200 ohms, nominal GGx: voltage input, 150,000 ohms; current input, 500 ohms	
Feedback Signal	AGF: 10,000 ohm potentiometer, 1 W GGx: DC 0 to 10 V or DC 2 to 10 V for 90° (10 VDC at 1 mA); Corresponds to input signal span selection	
Auxiliary Switch Rating	xGC: two single-pole, double-throw (SPDT) switches rated at AC 24 V, 1.5 A inductive, 3.0 A resistive, 35 VA maximum per switch, Class 2	
Torque Rating	80 lb·in (9 N·m)	
Cycle Life	100,000 full cycles; 2,500,000 repositions rated at 80 lb·in (9 N·m)	
Audible Noise Rating	35 dBA maximum at 39.4 in. (1 m)	
Rotation Range	Adjustable from 30° to 90°, CW or CCW	
Rotation Time	60 seconds at 60 Hz and 72 seconds at 50 Hz for 90°	
Electrical Connection	1/4 in. spade terminals (to order optional pluggable terminal blocks, see <i>Accessories</i>)	
Mechanical Connection	3/8 in. to 1/2 in. (10 mm to 12.7 mm) round shaft or 3/8 in. (10 mm) square shaft	
Enclosure Rating	NEMA 2, IP32	
Ambient Operating Rating	-4°F to 125°F (-20°C to 52°C); 90% RH maximum, noncondensing	
Ambient Storage Rating	-40°F to 176°F (-40°C to 80°C); 90% RH maximum, noncondensing	
Shipping Weight	2.4 lb (1.08 kg)	
Compliance 	United States	UL 873 Listed, File E27734, CCN XAPX
	Canada	CSA C22.2 No. 139 Certified, File LR85083, Class 3221 02
	Europe	CE Mark - Johnson Controls declares that this product is in compliance with the essential requirements and other relevant provisions of the EMC Directive 2004/108/EC.

M9116, M9124, and M9132 Series Electric Non-Spring-Return Actuators

Description

The M91xx Series includes M9116, M9124, and M9132 models. All of these direct-mount electric actuators operate on AC/DC 24 V power. The M91xx actuators are available for use with on/off, floating, proportional, or resistive controllers. These bidirectional actuators do not require a damper linkage, and are easily installed on a damper with a round shaft up to a 3/4 in. (20 mm) in diameter or a square shaft up to 5/8 in. (16 mm). They may be direct or remote mounted to a damper, or mounted to a valve using one of the M9000-5xx Valve Linkage Kits.

A single M91xx model delivers up to 280 lb-in (32 N·m) of torque. Two -AGx, -GGx, or -HGx models in tandem deliver twice the torque or 560 lb-in (64 N·m). The angle of rotation is mechanically adjustable from 0 to 90° in 5-degree increments. Integral auxiliary switches are available to indicate end-stop position or to perform switching functions at any angle within the selected rotation range. Position feedback is available through switches, a potentiometer, or a DC 0(2) to 10 V signal.

Features

- simple direct coupling reduces installation and commissioning time while improving reliability by eliminating damper linkages
- six torques: 70 lb-in to 560 lb-in (8 N·m to 64 N·m) offer the most suitable choice for the application
- four control inputs meet the needs of most applications
- output position feedback provides simple closed-loop control with accurate position sensing
- electronic stall detection ensures higher reliability by deactivating the actuator motor when a stall condition is detected

- master/slave operation allows synchronized control for two actuators
- stacked for tandem applications
- zero and span adjustment (-HGx models) allows sequential operation of dampers from a single input signal of DC 0(2) to 10 V, DC 0(4) to 20 V, or DC 0(4) to 20 mA
- jumper-selectable rotation direction and manual gear release simplify installation, setup, and field adjustments
- NPT threaded housing provides easy connection for electrical fittings
- manual gear release simplifies damper/valve setup and commissioning

Applications

M91xx actuators are designed to position air dampers and valves in HVAC systems. Applications include: positioning return air or exhaust dampers, controlling face and bypass dampers, positioning blades for variable volume fans, positioning VF Series butterfly valves, and positioning VG1000 Series ball valves. Two of the following models provide twice the amount of running torque of a single unit when mounted in tandem: M9116-GGx or -HGx, M9124-AGx, -GGx or -HGx, and M9132-AGx or -GGx.

Refer to the manufacturer's information to properly size the damper, valve, and/or actuator. These compact M91xx actuators use a DC motor with stall detection circuitry that operates throughout the entire stroke.

The -GGx, -HGx, and -JGx models employ noise-filtering techniques on the control signal to eliminate repositioning due to line noise.

Rotation is mechanically limited to 93° by integral end stops. The position of the actuator is visually indicated from 0° to 90° on the cover. An anti-rotation bracket prevents lateral movement of the actuator. Pressing the spring-loaded gear release on the actuator



M9116 Series Electric Non-Spring-Return Actuators

cover disengages the gear train for manual repositioning of the coupler.

Refer to the *M9116, M9124, M9132 Series Electric Non-Spring-Return Actuators Product Bulletin (LIT-2681058)* or the *M9116, M9124, M9132 Series Electric Non-Spring-Return Actuators Installation Instructions (Part No. 34-636-399)* for important product application information and single point of contact information.

Repair Information

If the M9116, M9124, or M9132 Series Electric Actuator fails to operate within its specifications, replace the unit. For a replacement actuator, contact the nearest Johnson Controls representative.

Selection Chart

M9116, M9124, and M9132 Series Electric Non-Spring-Return Actuators (Part 1 of 2)

Code Number	Control Type	Torque / Timing / Voltage	Auxiliary Switches	Comments
M9116 Electric Non-Spring-Return Actuators				
M9116-AGA-2	On/off, floating	140 lb-in (16 N·m) 70 to 115 seconds AC 24 V 50/60 Hz DC 24 V	None	
M9116-AGC-2			2-SPDT	
M9116-AGD-2			None	135 ohm potentiometer
M9116-AGE-2			None	1,000 ohm potentiometer
M9116-GGA-2	DC 0(2) to 10 V		None	DC 0(2) to 10 V feedback
M9116-GGC-2	DC 0(4) to mA proportional		2-SPDT	
M9116-HGA-2	DC 0 to 10 V		None	DC 0 to 10 V feedback
M9116-HGC-2	DC 0 to 20 mA proportional Adjustable start and span		2-SPDT	
M9116-JGA-2	100 ohm to 10,000 ohm potentiometer		None	
M9116-JGC-2			2-SPDT	

M9116, M9124, and M9132 Series Electric Non-Spring-Return Actuators (Continued)

M9116, M9124, and M9132 Series Electric Non-Spring-Return Actuators (Part 2 of 2)

Code Number	Control Type	Torque / Timing / Voltage	Auxiliary Switches	Comments		
M9124 Electric Non-Spring-Return Actuators						
M9124-AGA-2	On/off, floating	210 lb·in (24 N·m) 115 to 175 seconds AC 24 V 50/60 Hz DC 24 V	None			
M9124-AGC-2			2-SPDT			
M9124-AGD-2			None		135 ohm potentiometer	
M9124-AGE-2			None		1,000 ohm potentiometer	
M9124-GGA-2			DC 0(2) to 10 V		None	DC 0(2) to 10 V feedback
M9124-GGC-2			DC 0(4) to mA proportional		2-SPDT	
M9124-HGA-2			DC 0 to 10 V		None	DC 0 to 10 V feedback
M9124-HGC-2			DC 0 to 20 mA proportional Adjustable start and span		2-SPDT	
M9124-JGA-2			100 ohm to 10,000 ohm potentiometer		None	
M9124-JGC-2	2-SPDT					
M9132 Electric Non-Spring-Return Actuators						
M9132-AGA-2	On/off, floating	280 lb·in (32 N·m) 115 to 205 seconds AC 24 V 50/60 Hz DC 24 V	None			
M9132-AGC-2			2-SPDT			
M9132-AGE-2			None		1,000 ohm potentiometer	
M9132-GGA-2	DC 0(2) to 10 V	None	DC 0(2) to 10 V feedback			
M9132-GGC-2	DC 0(4) to mA proportional	2-SPDT				

Accessories

Code Number	Description
DMPR-KC003	Square head blade pin extension without bracket for Johnson Controls® CD-1300 direct-mount applications Note: Available with damper and may be ordered separately
DMPR-KC011	Hex head blade pin extension without bracket
DMPR-KC012	Hex head blade pin extension with bracket
DMPR-KC210	Damper jackshaft 1 in. diameter, 1 panel
DMPR-KC211	Damper jackshaft 1 in. diameter, 2 panel
DMPR-KC212	Damper jackshaft 1 in. diameter, 3 panel
DMPR-KC213	Damper jackshaft 1/2 in. diameter, 1 panel
DMPR-KC214	Damper jackshaft 1/2 in. diameter, 2 panel
M9000-103	14 VA transformer, 120/24 VAC, 60 Hz, Class 2
M9000-104	14 VA transformer, 230/24 VAC, 60 Hz, Class 2
M9000-105	Pluggable 3-terminal block
M9000-151	Base mount linkage kit for remote inside duct mounting (not intended for M9132 actuators or any tandem application)
M9000-153	Crankarm kit for remote mounting (not intended for M9132 actuators or any tandem application)
M9000-154	1 in. jackshaft coupler for mounting on a 1 in. diameter damper shaft
M9000-155	Manual handle for positioning a damper or valve when power is removed from an M91xx actuator
M9000-158	Mounting kit to tandem mount two M9116-GGx or -HGx models; two M9124-AGx, -GGx, or -HGx; or two M9132-AGx or -GGx models on a damper
M9000-160	Replacement anti-rotation bracket for M91xx Series actuators
M9000-518	Valve linkage kit for mounting M9124 actuators to 2-1/2 to 6 in. VG1xA5 Series flange body ball valves and to VG1243/VG1644 series 1 to 2 in. valves

M9116, M9124, and M9132 Series Electric Non-Spring-Return Actuators (Continued)

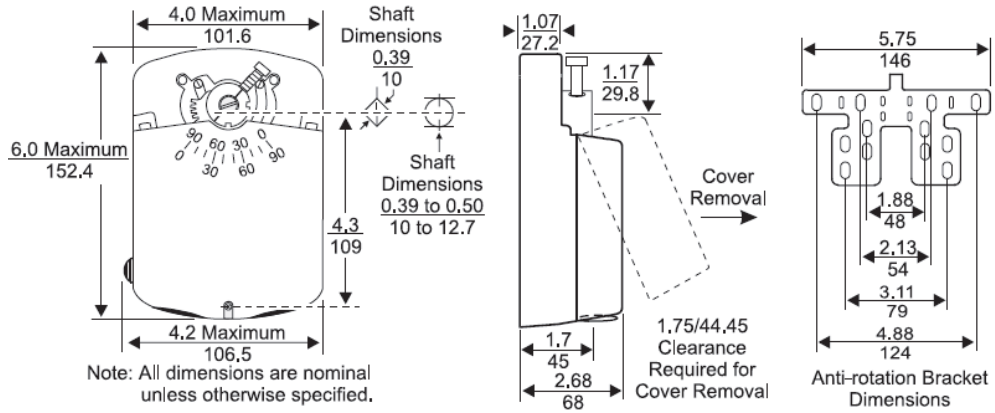

Dimensions, in./mm

M9116, M9124, and M9132 Series Electric Non-Spring-Return Actuators (Continued)

Technical Specifications

M9116, M9124, and M9132 Series Electric Non-Spring-Return Actuators		
Power Requirement	M9116-AGx: AC 20 to 30 V at 50/60 Hz or DC 24 V $\pm 10\%$; 6.5 VA supply minimum All other models: AC 20 to 30 V at 50/60 Hz or DC 24 V $\pm 10\%$; 7.5 VA supply minimum	
Control Type	AGx: on/off and floating GGx: DC 0(2) to 10 V or DC 0(4) to 20 mA proportional HGx: DC 0 to 10 V or DC 0 to 20 mA proportional with adjustable start and span JGx: proportional from 100 ohm to 10,000 ohm potentiometer controller	
Input Signal	AGx: V 24 AC at 50/60 Hz or DC 24 V GGx and HGx: DC 0(2) to 10 V, DC 0(4) to 20 V, or DC 0(4) to 20 mA JGx: potentiometer value is 100 ohms minimum to 10,000 ohms maximum	
Input Signal Adjustments	AGx: factory setting, terminals 1 and 2, CW rotation; terminals 1 and 3, CCW rotation GGx and HGx (voltage input or current input): Jumper selectable: DC 0(2) to 10 V, DC 0(4) to 20 V, or DC 0(4) to 20 mA Adjustable: zero, DC 0 to 6 V, DC 0 to 12 V, or DC 0 to 12 mA Span, DC 2 to 10 V, DC 4 to 20 V, or DC 4 to 20 mA Factory setting: DC 0 to 10 V, DC 0 to 20 mA, CW rotation with signal increase GGx, HGx, and JGx: action is jumper selectable direct (CW) or reverse (CCW) with signal increase.	
Input Impedance	GGx and HGx: voltage input, 205,000 ohms for 0 (2) to 10 V and 410,000 ohms for 0 (4) to 20 V; current input, 500 ohms JGx: 1.8 megohms	
Feedback Signal	AGD: 135 ohm feedback potentiometer AGE: 1,000 ohm feedback potentiometer GGx and HGx: DC 0 to 10 V or DC 2 to 10 V for 90° (10 VDC at 1 mA) corresponds to input signal span selection. JGx: DC 0 to 10 V for 90° (10 VDC at 1 mA)	
Auxiliary Switch Rating	xGC: two single-pole, double-throw (SPDT) switches rated at 24 VAC 1.5 A inductive, 3.0 A resistive, 35 VA maximum per switch, Class 2	
Torque Rating	M9116: 140 lb-in (16 N·m) for one unit, 280 lb-in (32 N·m) for two in tandem (-GGx, -HGx) M9124: 210 lb-in (24 N·m) for one unit, 420 lb-in (48 N·m) for two in tandem (-AGx, -GGx, -HGx) M9132: 280 lb-in (32 N·m) for one unit, 560 lb-in (64 N·m) for two in tandem (-AGx, -GGx)	
Cycle Life	M9116 and M9124 60,000 cycles at rated load M9132 30,000 cycles at rated load	
Audible Noise Rating	45 dBA at 1 m	
Rotation Range	0° to 90° in 5-degree increments, mechanically limited to 93° - rotation range is adjusted by repositioning the output hub	
Rotation Time	M9116: 80 seconds at 50% rated load, 70 to 115 seconds for 0 lb-in to 140 lb-in (0 N·m to 16 N·m) M9124: 130 seconds at 50% rated load, 115 to 175 seconds for 0 lb-in to 210 lb-in (0 N·m to 24 N·m) M9132: 140 seconds at 50% rated load, 115 to 205 seconds for 0 lb-in to 280 lb-in (0 N·m to 32 N·m)	
Electrical Connection	M9124- and M9132-AGx: 1/4 in. spade terminals with pluggable 3-terminal blocks (see Accessories) All other models: screw terminals for 22 AWG to 14 AWG; maximum of two 18, 20, or 22 AWG per terminal	
Mechanical Connection	3/8 in. to 3/4 in. (10 mm to 20 mm) diameter round shaft or 3/8 in. to 5/8 in. (10 mm to 16 mm) square shaft 1 in. (25.4 mm) diameter jackshaft with M9000-154 coupler	
Enclosure Rating	NEMA 2, IP42	
Ambient Operating Rating	-4°F to 122°F (-20°C to 50°C); 0% to 95% RH, noncondensing	
Ambient Storage Rating	-40°F to 186°F (-40°C to 86°C); 0% to 95% RH, noncondensing	
Shipping Weight	2.9 lb (1.3 kg)	
Compliance 	United States	UL 873 Listed, File E27734, CCN XAPX
	Canada	CSA C22.2 No. 139 Certified, File LR85083, Class 3221 02
	Europe	CE Mark - Johnson Controls declares that this product is in compliance with the essential requirements and other relevant provisions of the EMC Directive and Low Voltage Directive.
	Australia and New Zealand	RCM Mark, Australia/NZ Emissions Compliant (Models: All M9220-xGx and M9220-xDx)

M9203-xxx-2(Z) Series Electric Spring-Return Actuators

Description

The M9203-xxx-2(Z) Series Electric Spring-Return Actuators provide control of dampers in HVAC systems. All actuators in this series provide 27 lb-in (3 N-m) rated torque. A mechanical spring-return system provides rated torque with and without power applied to the actuator. The series includes the following control options:

- On/Off, 24 V, 85 to 264 VAC power
- On/Off and Floating Point, 24 V power
- Proportional, 24 V power, for 0(2) VDC to 10 VDC or 0(4) mA to 20 mA Control Signal

These actuators are configured for direct mounting and do not require a damper linkage. Actuators can be mounted directly to a damper shaft from 1/4 to 1/2 in. (6 to 12 mm) diameter with a universal clamp. An accessory crankarm and remote mounting kit are available for applications where the actuator cannot be direct-coupled to the damper shaft. An optional line voltage auxiliary switch indicates an end-stop position or performs switching functions within the selected rotation range.

Refer to the *M9203-xxx-2(Z) Series Electric Spring-Return Actuators Product Bulletin (LIT-12011674)* for important product application information.

Features

- 27 lb-in (3 N-m) rated torque
- direct-coupled design
- reversible mounting
- electronic stall detection
- double-insulated construction
- microprocessor-controlled brushless DC motor (-AGx and -GGx types)
- external mode selection switch (-AGx and -GGx types)
- integral cables with colored and numbered conductors
- integral 1/2 in. (13 mm) threaded conduit connectors
- optional integrated auxiliary switch
- plenum rated models
- override control (proportional models only)
- Underwriters Laboratories Inc.® (UL), CE, and C-Tick compliance
- manufactured under International Standards Organization (ISO) 9001 quality control standards
- 5-year warranty



M9203-xxx-2(Z) Series Electric Spring-Return Actuator

Accessories and Replacement Parts

Code Number	Description
DMPR-KC003	7 in. (178 mm) Blade Pin Extension (without Bracket) for Johnson Controls Direct-Mount Damper Applications (Quantity 1) Note: Available with damper and may be ordered separately
M9000-322	Weather Shield Kit for Damper Application of M9203, M9208, VA9104, VA9308/9310 Series Electric Actuators (Quantity 1)
M9000-400	Jackshaft Linkage Adapter Kit (Quantity 1)
M9000-560	Ball Valve Linkage Kit for Applying M9104, M9203, and M9208 Series Electric Actuators to VG1000 Series Valves (Quantity 1)
M9000-561	Thermal Barrier Kit for M9000-560 Ball Valve Linkage. Extends M(VA)9104, M(VA)9203, and M(VA)9208 Series Electric Spring-Return Actuators Applications to Include Low-Pressure Steam (Quantity 1)
M9000-604	Replacement Anti-Rotation Bracket Kit for M9203, M9208, M9210, and M9220 Series Electric Spring-Return Actuators (Quantity 1)
M9000-606	Position Indicator for Damper Applications (Quantity 5)
M9000-607	Position Indicator for VG1000 Series Ball Valve Applications (Quantity 5)
M9203-100	Remote Mounting Kit with Crankarm Kit (Quantity 1)
M9203-110	Universal Mounting Kit without Crankarm Kit (Quantity 1)
M9203-115	Universal Mounting Kit with Crankarm Kit (Quantity 1)
M9203-150	Crankarm Kit (Quantity 1)
M9203-250	Remote Mounting Kit with Crankarm Kit and Damper Linkage for D1300 Dampers (Quantity 1)
M9203-601	Replacement Standard Coupler Kit (with Retainer) for Mounting M9203 Series Electric Spring-Return Actuators (Quantity 1)
M9203-602	Replacement Retainer for M9203 Series Electric Spring-Return Actuators (Quantity 5)
M9203-603	Adjustable Stop Kit for M9203 Series Electric Spring-Return Actuators (Quantity 1)

M9203-xxx-2(Z) Series Electric Spring-Return Actuators (Continued)

Selection Chart

Code Number	Rotation Time (Seconds) for 90°		Power Requirements		Power Consumption			Input Signal			Position Feedback	Auxiliary Switch	Electrical Connection		
	Power On — Running	Power Off — Spring Return	24 VAC +/- 20%, VDC +/-10%	85 to 264 VAC	VA Rating, Transformer Sizing	VA: Running (Holding)	Amperage: Running (Holding)	On/Off	On/Off and Floating Point	0(2) to 10 VDC 0(4) to 20 mA (with 500 Ohm Resistor)			0(2) to 10 VDC	1 SPDT, 5.0 A (2.9 A Inductive) at 240 V	48 in. (1.2 m) 18 AWG Appliance Cable
M9203-AGA-2	150	< 25	■		6	4.7 (2.7)	—		■				■		■
M9203-AGB-2	150	< 25	■		6	4.7 (2.7)	—		■			■	■		■
M9203-AGA-2Z	90	< 25	■		6	5.1 (2.8)	—		■				■		■
M9203-AGB-2Z	90	< 25	■		6	5.1 (2.8)	—		■				■		■
M9203-BGA-2	< 75	< 25	■		6	5.0 (2.5)	—	■					■		■
M9203-BGB-2	< 75	< 25	■		6	5.0 (2.5)	—	■					■		■
M9203-BUA-2	< 75	< 25		■		—	0.06 (0.02)	■					■		■
M9203-BUB-2	< 75	< 25		■		—	0.06 (0.02)	■					■		■
M9203-BUA-2Z	< 30	< 25		■		—	0.08 (0.02)	■					■		■
M9203-BUB-2Z	< 30	< 25		■		—	0.08 (0.02)	■					■		■
M9203-GGA-2	150	< 25	■		6	4.7 (2.7)	—			■	■			■	■
M9203-GGB-2	150	< 25	■		6	4.7 (2.7)	—			■	■		■		■
M9203-GGA-2Z	90	< 25	■		6	5.1 (2.8)	—			■	■			■	■
M9203-GGB-2Z	90	< 25	■		6	5.1 (2.8)	—			■	■			■	■

The performance specifications are nominal and conform to acceptable industry standards. For applications at conditions beyond these specifications, consult the local Johnson Controls office. Johnson Controls shall not be liable for damages resulting from misapplication or misuse of its products. © 2019 Johnson Controls. www.johnsoncontrols.com

M9203-xxx-2(Z) Series Electric Spring-Return Actuators (Continued)

Technical Specifications

M9203-GGx-2(Z) Series Proportional Electric Spring-Return Actuator (Part 1 of 2)		
Power Requirements	-GGx-2 Models	AC 24 V (AC 19.2 V to 28.8 V) at 50/60 Hz: Class 2 (North America) or Safety Extra-Low Voltage (SELV) (Europe), 4.7 VA Running, 2.7 VA Holding Position DC 24 V (DC 21.6 V to 28.8 V): Class 2 (North America) or SELV (Europe), 1.8 W Running, 1 W Holding Position Minimum Transformer Size: 6 VA per Actuator
	-GGx-2Z Models	AC 24 V (AC 19.2 V to 28.8 V) at 50/60 Hz: Class 2 (North America) or Safety Extra-Low Voltage (SELV) (Europe), 5.1 VA Running, 2.8 VA Holding Position DC 24 V (DC 19.2 V to 28.8 V): Class 2 (North America) or SELV (Europe), 1.9 W Running, 1.1 W Holding Position Minimum Transformer Size: 6 VA per Actuator
Input Signal / Adjustments		Factory Set at DC 0 to 10 V, CW Rotation with Signal Increase Selectable DC 0 (2) to 10 V or 0 (4) to 20 mA with Field Furnished 500 Ohm, 0.25 W Minimum Resistor Switch Selectable Direct or Reverse Action with Signal Increase
Control Input Impedance		Voltage Input: 100,000 Ohms Current Input: 500 Ohms with Field Furnished 500 Ohm Resistor
Feedback Signal		DC 0 (2) to 10 V for Desired Rotation Range up to 95° Corresponds to Rotation Limits, 0.5 mA at 10 V Maximum
Auxiliary Switch Rating	-xxB Models	One Single-Pole, Double-Throw (SPDT), Double-Insulated Switch with Silver Contacts: AC 24 V, 50 VA Pilot Duty AC 120 V, 5.8 A Resistive, 1/4 hp, 275 VA Pilot Duty AC 240 V, 5.0 A Resistive, 1/4 hp, 275 VA Pilot Duty
Spring Return		Direction is Selectable with Mounting Position of Actuator: Actuator Face Labeled A is away from Damper or Valve: CCW Spring Return Actuator Face Labeled B is away from Damper or Valve: CW Spring Return
Rated Torque	Power On (Running)	27 lb-in (3 N·m) All Operating Temperatures
	Power Off (Spring Returning)	27 lb-in (3 N·m) All Operating Temperatures
Rotation Range		Maximum Full Stroke: 95° Adjustable Stop: 35° to 95° Maximum Position
Rotation Time for 90 Degrees of Travel	Power On (Running) -GGx-2 Models	150 Seconds Constant for 0 lb-in to 27 lb-in (3 N·m) Load, at All Operating Conditions
	Power On (Running) -GGx-2Z Models	90 Seconds Constant for 0 lb-in to 27 lb-in (3 N·m) Load, at All Operating Conditions
	Power Off (Spring Returning)	12 to 17 Seconds for 0 lb-in to 27 lb-in (3 N·m) Load, at Room Temperature 16 Seconds Nominal at Full Rated Load 22 Seconds Maximum with 27 lb-in (3 N·m) Load, at -22°F (-30°C)
Life Cycles		60,000 Full Stroke Cycles with 27 lb-in (3 N·m) Load 1,500,000 Repositions with 27 lb-in (3 N·m) Load
Audible Noise Rating	Power On (Running) -GGx-2 Models	< 28 dBA at 27 lb-in (3 N·m) Load, at a Distance of 39-13/32 in. (1 m)
	Power On (Running) -GGx-2Z Models	< 37 dBA at 27 lb-in (3 N·m) Load, at a Distance of 39-13/32 in. (1 m)
	Power On (Holding)	< 20 dBA at a Distance of 39-13/32 in. (1 m)
	Power Off (Spring Returning)	< 56 dBA at 27 lb-in (3 N·m) Load, at a Distance of 39-13/32 in. (1 m)
Electrical Connections	-GGA-2(Z) Models	120 in. (3.05 m) UL 444 Type CMP Plenum Rated Cable with 19 AWG (0.75 mm ²) Conductors and 0.25 in. (6 mm) Ferrule Ends
	Auxiliary Switch (-xxB Models)	48 in. (1.2 m) UL 758 Type AWM Halogen-Free Cable with 18 AWG (0.85 mm ²) Conductors and 0.25 in. (6 mm) Ferrule Ends
Conduit Connections		Integral 1/2 in. (13 mm) Threaded Conduit Connectors
Mechanical Connections	Round Shafts	Range of Sizes: 1/4 in. to 1/2 in. (6 mm to 12 mm)
	Square Shafts	Range of Sizes: 1/4 in. to 5/16 in. (6 mm to 8 mm)
Enclosure Rating		NEMA 2 (IP54) for All Mounting Orientations
Ambient Conditions	Standard Operating	-22°F to 140°F (-30°C to 60°C); 90% RH Maximum, Noncondensing
	Storage	-40°F to 185°F (-40°C to 85°C); 95% RH Maximum, Noncondensing
Dimensions		6.38 in. x 3.23 in. x 2.26 in. (162 mm x 82 mm x 57.5 mm)

The performance specifications are nominal and conform to acceptable industry standards. For applications at conditions beyond these specifications, consult the local Johnson Controls office. Johnson Controls shall not be liable for damages resulting from misapplication or misuse of its products. © 2019 Johnson Controls. www.johnsoncontrols.com

M9203-xxx-2(Z) Series Electric Spring-Return Actuators (Continued)

M9203-GGx-2(Z) Series Proportional Electric Spring-Return Actuator (Part 2 of 2)		
	United States	UL Listed, CCN XAPX, File E27734; to UL 60730-1A: 2003-08, Ed. 3.1, Automatic Electrical Controls for Household and Similar Use; and UL 60730-2-14: 2002-02, Ed. 1, Part 2, Particular Requirements for Electric Actuators. (Models: All)
	Canada	UL Listed, CCN XAPX7, File E27734; to UL 60730-1:02-CAN/CSA: July 2002, 3rd Ed., Automatic Electrical Controls for Household and Similar Use; and CSA C22.2 No. 24-93 Temperature Indicating and Regulating Equipment. (Models: All)
	Europe	CE Mark – Johnson Controls declares that this product is in compliance with the essential requirements and other relevant provisions of the EMC Directive 2004/108/EC and Low Voltage Directive 2006/95/EC.
	Australia and New Zealand	C-Tick Mark, Australia/NZ Emissions Compliant. (Models: All)
Shipping Weight		-GGA Models: 2.0 lb (0.9 kg) -GGB Models: 2.4 lb (1.1 kg)

M9203-AGx-2(Z) Series On/Off and Floating Point Control Electric Spring-Return Actuator (Part 1 of 2)		
Power Requirements	-AGx-2 Models	AC 24 V (AC 19.2 V to 28.8 V) at 50/60 Hz: Class 2 (North America) or Safety Extra-Low Voltage (SELV) (Europe), 4.7 VA Running, 2.7 VA Holding Position DC 24 V (DC 21.6 V to 28.8 V): Class 2 (North America) or SELV (Europe), 1.8 W Running, 1 W Holding Position Minimum Transformer Size: 6 VA per Actuator
	-AGx-2Z Models	AC 24 V (AC 19.2 V to 28.8 V) at 50/60 Hz: Class 2 (North America) or Safety Extra-Low Voltage (SELV) (Europe), 5.1 VA Running, 2.8 VA Holding Position DC 24 V (DC 19.2 V to 28.8 V): Class 2 (North America) or SELV (Europe), 1.9 W Running, 1.1 W Holding Position Minimum Transformer Size: 6 VA per Actuator
Input Signal	-AGx-2(Z) Models	AC 19.2 to 28.8 V at 50/60 Hz or DC 24 V +20%/-10% Class 2 (North America) or SELV (Europe) Minimum Pulse Width: 500 ms
Control Input Impedance	-AGx-2(Z) Models	4,700 Ohms
Auxiliary Switch Rating	-xxB Models	One Single-Pole, Double-Throw (SPDT), Double-Insulated Switch with Silver Contacts: AC 24 V, 50 VA Pilot Duty AC 120 V, 5.8 A Resistive, 1/4 hp, 275 VA Pilot Duty AC 240 V, 5.0 A Resistive, 1/4 hp, 275 VA Pilot Duty
Spring Return		Direction is Selectable with Mounting Position of Actuator: Actuator Face Labeled A is away from Damper or Valve: CCW Spring Return Actuator Face Labeled B is away from Damper or Valve: CW Spring Return
Rated Torque	Power On (Running)	27 lb-in (3 N·m) All Operating Temperatures
	Power Off (Spring Returning)	27 lb-in (3 N·m) All Operating Temperatures
Rotation Range		Maximum Full Stroke: 95° Adjustable Stop: 35° to 95° Maximum Position
Rotation Time for 90 Degrees of Travel	Power On (Running) -AGx-2 Models	150 Seconds Constant for 0 lb-in to 27 lb-in (3 N·m) Load, at All Operating Conditions
	Power On (Running) -AGx-2Z Models	90 Seconds Constant for 0 lb-in to 27 lb-in (3 N·m) Load, at All Operating Conditions
	Power Off (Spring Returning)	12 to 17 Seconds for 0 lb-in to 27 lb-in (3 N·m) Load, at Room Temperature 16 Seconds Nominal at Full Rated Load 22 Seconds Maximum with 27 lb-in (3 N·m) Load at -22°F (-30°C)
Life Cycles		60,000 Full Stroke Cycles with 27 lb-in (3 N·m) Load 1,500,000 Repositions with 27 lb-in (3 N·m) Load
Audible Noise Rating	Power On (Running) -AGx-2 Models	< 28 dBA at 27 lb-in (3 N·m) Load, at a Distance of 39-13/32 in. (1 m)
	Power On (Running) -AGx-2Z Models	< 37 dBA at 27 lb-in (3 N·m) Load, at a Distance of 39-13/32 in. (1 m)
	Power On (Holding)	< 20 dBA at a Distance of 39-13/32 in. (1 m)
	Power Off (Spring Returning)	< 56 dBA at 27 lb-in (3 N·m) Load, at a Distance of 39-13/32 in. (1 m)

M9203-xxx-2(Z) Series Electric Spring-Return Actuators (Continued)

M9203-AGx-2(Z) Series On/Off and Floating Point Control Electric Spring-Return Actuator (Part 2 of 2)		
Electrical Connections	-AGA-2(Z) Models	120 in. (3.05 m) UL 444 Type CMP Plenum Rated Cable with 19 AWG (0.75 mm ²) Conductors and 0.25 in. (6 mm) Ferrule Ends
	Auxiliary Switch (-xxB Models)	48 in. (1.2 m) UL 758 Type AWM Halogen-Free Cable with 18 AWG (0.85 mm ²) Conductors and 0.25 in. (6 mm) Ferrule Ends
Conduit Connections		Integral 1/2 in. (13 mm) Threaded Conduit Connectors
Mechanical Connections	Round Shafts	Range of Sizes: 1/4 in. to 1/2 in. (6 mm to 12 mm)
	Square Shafts	Range of Sizes: 1/4 in. to 5/16 in. (6 mm to 8 mm)
Enclosure Rating		NEMA 2 (IP54) for All Mounting Orientations
Ambient Conditions	Standard Operating	-22°F to 140°F (-30°C to 60°C); 90% RH Maximum, Noncondensing
	Storage	-40°F to 185°F (-40°C to 85°C); 95% RH Maximum, Noncondensing
Dimensions		6.38 in. x 3.23 in. x 2.26 in. (162 mm x 82 mm x 57.5 mm)
Compliance	United States	UL Listed, CCN XAPX, File E27734; to UL 60730-1A: 2003-08, Ed. 3.1, Automatic Electrical Controls for Household and Similar Use; and UL 60730-2-14: 2002-02, Ed. 1, Part 2, Particular Requirements for Electric Actuators. (Models: All)
	Canada	UL Listed, CCN XAPX7, File E27734; to UL 60730-1:02-CAN/CSA: July 2002, 3rd Ed., Automatic Electrical Controls for Household and Similar Use; and CSA C22.2 No. 24-93 Temperature Indicating and Regulating Equipment (Models: All)
	Europe	CE Mark – Johnson Controls declares that this product is in compliance with the essential requirements and other relevant provisions of the EMC Directive 2004/108/EC and Low Voltage Directive 2006/95/EC.
	Australia and New Zealand	C-Tick Mark, Australia/NZ Emissions Compliant (Models: All)
Shipping Weight		-AGA Models: 2.0 lb (0.9 kg) -AGB Models: 2.4 lb (1.1 kg)

M9203-Bxx-2(Z) Series On/Off Electric Spring-Return Actuators (Part 1 of 2)		
Power Requirements	-BGx-2 Models	AC 24 V (AC 19.2 V to 28.8 V) at 50/60 Hz: Class 2 (North America) or Safety Extra-Low Voltage (SELV) (Europe), 5 VA Running, 1.6 VA Holding Position DC 24 V (DC 21.6 V to 28.8 V): Class 2 (North America) or SELV (Europe), 2.8 W Running, 0.8 W Holding Position Minimum Transformer Size: 6 VA per Actuator
	-BUx-2 Models	AC 100 to 240 V (AC 85 V to 264 V) at 50/60 Hz: 0.06 A Running, 0.02 A Holding Position
	-BUx-2Z Models	AC 100 to 240 V (AC 85 V to 264 V) at 50/60 Hz: 0.08 A Running, 0.02 A Holding Position
Auxiliary Switch Rating	-xxB Models	One Single-Pole, Double-Throw (SPDT), Double-Insulated Switch with Silver Contacts: AC 24 V, 50 VA Pilot Duty AC 120 V, 5.8 A Resistive, 1/4 hp, 275 VA Pilot Duty AC 240 V, 5.0 A Resistive, 1/4 hp, 275 VA Pilot Duty
Spring Return		Direction is Selectable with Mounting Position of Actuator: Actuator Side A is away from Damper or Valve: CCW Spring Return Actuator Side B is away from Damper or Valve: CW Spring Return
Rated Torque	Power On (Running)	27 lb·in (3 N·m) All Operating Temperatures
	Power Off (Spring Returning)	27 lb·in (3 N·m) All Operating Temperatures
Rotation Range		Maximum Full Stroke: 95° Adjustable Stop: 35 to 95° Maximum Position
Rotation Time for 90 Degrees of Travel	Power On (Running) -Bxx-2 Models	53 to 71 Seconds for 0 lb·in to 27 lb·in (3 N·m) Load, at Room Temperature 60 Seconds Nominal at Full Rated Load (0.25 rpm)
	Power On (Running) -BUx-2Z Models	24 to 28 Seconds for 0 lb·in to 27 lb·in (3 N·m) Load, at Room Temperature 27 Seconds Nominal at Full Rated Load (0.5 rpm)
	Power Off (Spring Returning)	19 to 23 Seconds for 0 lb·in to 27 lb·in (3 N·m) Load, at Room Temperature 22 Seconds Nominal at Full Rated Load 28 Seconds Maximum with 27 lb·in (3 N·m) Load at -22°F (-30°C)
Life Cycles		60,000 Full-Stroke Cycles with 27 lb·in (3 N·m) Load

M9203-xxx-2(Z) Series Electric Spring-Return Actuators (Continued)

M9203-Bxx-2(Z) Series On/Off Electric Spring-Return Actuators (Part 2 of 2)		
Audible Noise Rating	Power On (Running) -Bxx-2 Models	< 36 dBA at 27 lb-in (3 N-m) Load, at a Distance of 39-13/32 in. (1 m)
	Power On (Running) -BUx-2Z Models	< 45 dBA at 27 lb-in (3 N-m) Load, at a Distance of 39-13/32 in. (1 m)
	Power On (Holding)	< 20 dBA at a Distance of 39-13/32 in. (1 m)
	Power Off (Spring Returning)	< 51 dBA at 27 lb-in (3 N-m) Load, at a Distance of 39-13/32 in. (1 m)
Electrical Connections	Actuator (All Models)	48 in. (1.2 m) UL 758 Type AWM Halogen-Free Cable with 18 AWG (0.85 mm ²) Conductors and 0.25 in. (6 mm) Ferrule Ends
	Auxiliary Switch (-xxB Models)	48 in. (1.2 m) UL 758 Type AWM Halogen-Free Cable with 18 AWG (0.85 mm ²) Conductors and 0.25 in. (6 mm) Ferrule Ends
Conduit Connections	Integral 1/2 in. (13 mm) Threaded Conduit Connectors	
Mechanical Connections	Round Shafts	Range of Sizes: 1/4 in. to 1/2 in. (6 mm to 12 mm)
	Square Shafts	Range of Sizes: 1/4 in. to 5/16 in. (6 mm to 8 mm)
Enclosure Rating	NEMA 2 (IP54) for All Mounting Orientations	
Ambient Conditions	Standard Operating	-22°F to 140°F (-30°C to 60°C); 90% RH Maximum, Noncondensing
	Storage	-40°F to 185°F (-40°C to 85°C); 95% RH Maximum, Noncondensing
Dimensions	6.38 in. x 3.23 in. x 2.26 in. (162 mm x 82 mm x 57.5 mm)	
Compliance 	United States	UL Listed, CCN XAPX, File E27734; to UL 60730-1A: 2003-08, Ed. 3.1, Automatic Electrical Controls for Household and Similar Use; and UL 60730-2-14: 2002-02, Ed. 1, Part 2, Particular Requirements for Electric Actuators. (Models: All)
	Canada	UL Listed, CCN XAPX7, File E27734; to UL 60730-1:02-CAN/CSA: July 2002, 3rd Ed., Automatic Electrical Controls for Household and Similar Use; and CSA C22.2 No. 24-93 Temperature Indicating and Regulating Equipment (Models: All).
	Europe	CE Mark – Johnson Controls declares that this product is in compliance with the essential requirements and other relevant provisions of the EMC Directive 2004/108/EC and Low Voltage Directive 2006/95/EC.
	Australia and New Zealand	C-Tick Mark, Australia/NZ Emissions Compliant (Models: All)
Shipping Weight	-BxA Models: 2.0 lb (0.9 kg) -BxB Models: 2.4 lb (1.1 kg)	

M9208-xxx-x Series Electric Spring-Return Actuators

Description

The M9208-xxx-x Series Electric Spring-Return Actuators provide control of dampers in HVAC systems. All actuators in this series provide 70 lb·in (8 N·m) rated torque. A mechanical spring-return system provides rated torque with and without power applied to the actuator. The series includes the following control options:

- On/Off, 24 V, 120 VAC, 230 VAC power
- On/Off and Floating Point, 24 V power
- Proportional, 24 V power, for 0(2) to 10 VDC or 0(4) to 20 mA Control Signal

These actuators are configured for direct mounting and do not require a damper linkage. Actuators can be mounted directly to a damper shaft from 5/16 to 5/8 in. (8 to 16 mm) diameter with a universal clamp. For shafts up to 3/4 in. (19 mm) diameter, use the accessory Large Shaft Coupler Kit M9208-600. An accessory crankarm and remote mounting kit are available for applications where the actuator cannot be direct coupled to the damper shaft. Optional line voltage auxiliary switches indicate an end-stop position or perform switching functions within the selected rotation range.

Refer to the *M9208-xxx-x Series Electric Spring-Return Actuators Product Bulletin (LIT-12011480)* for important product application and single point of contact information.

Features

- 70 lb·in (8 N·m) rated torque
- direct-coupled design
- reversible mounting
- electronic stall detection
- double-insulated construction
- microprocessor-controlled brushless DC motor (-AGx and -GGx types)
- external mode selection switch (-AGx and -GGx types)
- locking manual override with auto release and crank storage
- integral cables with colored and numbered conductors
- integral connectors for 3/8 in. (10 mm) Flexible Metal Conduit (FMC)
- optional integrated auxiliary switches
- UL, CE, and C-Tick compliance
- manufactured under International Standards Organization (ISO) 9001 quality control standards
- 5-year warranty



M9208-xxx-x Series Electric Spring-Return Actuator

Accessories and Replacement Parts

Code Number	Description
DMPR-KC003	7 in. (178 mm) Blade Pin Extension (without Bracket) for Johnson Controls Direct-Mount Damper Applications (Quantity 1) Note: Available with damper and may be ordered separately.
M9000-322	Weather Shield Kit for Damper Application of M9203, M9208, VA9104, and VA9308/9310 Series Electric Spring-Return Actuators (Quantity 1)
M9000-400	Jackshaft Linkage Kit. Open-Ended Design Enables Clamping onto a Jackshaft without Requiring Access to the Ends of the Jackshaft. (Quantity 1)
M9000-560	Ball Valve Linkage Kit for applying M9203 and M9208 Series Electric Spring-Return Actuators to VG1000 Series Valves (Quantity 1)
M9000-604	Replacement Anti-Rotation Bracket Kit for M9208, M9210, and M9220 Series Electric Spring-Return Actuators (Quantity 1)
M9000-606	Position Indicator for Damper Applications of M9203 and M9208 Series Actuators (Quantity 5)
M9200-100	Threaded Conduit Adapter, 1/2 NPSM, for M9210(20) and M(VA)9208 Series Actuators (Quantity 5)
M9208-100	Remote Mounting Kit, Including Mounting Bracket, M9208-150 Crankarm, Ball Joint, and Mounting Fasteners (Quantity 1)
M9208-150	Crankarm Adapter Kit (Quantity 1)
M9208-600	Large Shaft Coupler Kit (with Locking Clip) for Mounting M9208 Series Electric Spring-Return Actuators on Dampers with Round Shafts from 1/2 in. to 3/4 in. (12 mm to 19 mm) or Square Shafts from 3/8 in. to 9/16 in. (10 mm to 14 mm) (Quantity 1)
M9208-601	Replacement Standard Coupler Kit (with Locking Clip) for Mounting M9208 Series Electric Spring-Return Actuators on Dampers with Round Shafts from 5/16 in. to 5/8 in. (8 mm to 16 mm) or Square Shafts from 1/4 in. to 1/2 in. (6 mm to 12 mm) (Quantity 1)
M9208-602	Replacement Locking Clips for M9208 Series Electric Spring-Return Actuators (Quantity 5)
M9208-603	Adjustable Stop Kit for M9208 Series Electric Spring-Return Actuators (Quantity 1)
M9220-604	Replacement Manual Override Cranks for M9208 Series Electric Spring-Return Actuators with Long Crank Radius: 2.83 in. (72 mm) (Quantity 5)
M9208-605	Replacement Manual Override Cranks for M9208 Series Electric Spring-Return Actuators with Short Crank Radius: 1.83 in. (46.5 mm) (Quantity 5)

M9208-xxx-x Series Electric Spring-Return Actuators (Continued)

Selection Chart

Code Number	Rotation Time (Seconds) for 90°		Power Requirements				Power Consumption			Input Signal		Position Feedback	Auxiliary Switches	Electrical Connection			
	Power On (Running)	Power Off (Spring Return)	24 VAC +/- 25%, VDC +20%/-10%	24 VAC +/- 20%, VDC +20%/-10%	120 VAC +/- 10%	230 VAC +/- 10%	VA Rating, Transformer Sizing	VA: Running (Holding)	Amperage: Running (Holding)	On/Off	Floating Point			0(2) to 10 VDC 0(4) to 20 mA (with 500 Ohm Resistor)	0(2) to 10 VDC	2 Single-Pole, Double-Throw (SPDT), 5.0 A (2.9 A inductive) at 240 V	48 in. (1.2 m) 18 AWG Appliance Cable
M9208-AGA-2	150	17 to 25 ¹		■			8	7.9 (5.5)	—	■	■					■	■
M9208-AGA-3	150	17 to 25 ¹		■			8	7.9 (5.5)	—	■	■					■	■
M9208-AGC-3	150	17 to 25 ¹		■			8	7.9 (5.5)	—	■	■		■				■
M9208-BGA-3	55 to 71	13 to 26 ²	■				7	6.1 (1.2)	—	■							■
M9208-BGC-3	55 to 71	13 to 26 ²	■				7	6.1 (1.2)	—	■							■
M9208-BAA-3	55 to 71	13 to 26 ²			■		—	—	0.05 (0.03)	■							■
M9208-BAC-3	55 to 71	13 to 26 ²			■		—	—	0.05 (0.03)	■							■
M9208-BDA-3	55 to 71	13 to 26 ²				■	—	—	0.04 (0.03)	■							■
M9208-BDC-3	55 to 71	13 to 26 ²				■	—	—	0.04 (0.03)	■							■
M9208-GGA-2	150	17 to 25 ¹		■			8	7.9 (5.5)	—			■	■				■
M9208-GGA-3	150	17 to 25 ¹		■			8	7.9 (5.5)	—			■	■				■
M9208-GGC-3	150	17 to 25 ¹		■			8	7.9 (5.5)	—			■	■				■

- 22 seconds nominal at room temperature and rated load, 94 seconds maximum at rated load and -40°F (-40°C)
- 21 seconds nominal at room temperature and rated load, 39 seconds maximum at rated load and -4°F (-20°C), 108 seconds maximum at 53 lb·in (6 N·m) and -40°F (-40°C)

M9208-xxx-x Series Electric Spring-Return Actuators (Continued)

Technical Specifications

M9208-GGx-x Series Proportional Electric Spring-Return Actuator (Part 1 of 2)		
Power Requirements	-GGx Models	AC 24 V (AC 19.2 V to 28.8 V) at 50/60 Hz: Class 2 (North America) or Safety Extra-Low Voltage (SELV) (Europe), 7.9 VA Running, 5.5 VA Holding Position DC 24 V (DC 21.6 V to 28.8 V): Class 2 (North America) or SELV (Europe), 3.5 W Running, 1.9 W Holding Position Minimum Transformer Size: 8 VA per Actuator
Input Signal / Adjustments	-GGx Models	Factory Set at DC 0 to 10 V, CW Rotation with Signal Increase; Selectable DC 0 (2) to 10 V or 0 (4) to 20 mA with Field Furnished 500 Ohm, 0.25 W Minimum Resistor; Switch Selectable Direct or Reverse Action with Signal Increase
Control Input Impedance	-GGx Models	Voltage Input: 100,000 Ohms Current Input: 500 Ohms with Field Furnished 500 Ohm Resistor
Feedback Signal	-GGx Models	DC 0 (2) to 10 V for Desired Rotation Range up to 95° Corresponds to Rotation Limits, 0.5 mA at 10 V Maximum
Auxiliary Switch Rating	-xxC Models	Two Single-Pole, Double-Throw (SPDT), Double-Insulated Switches with Gold over Silver Contacts: AC 24 V, 50 VA Pilot Duty AC 120 V, 5.8 A Resistive, 1/4 hp, 275 VA Pilot Duty AC 240 V, 5.0 A Resistive, 1/4 hp, 275 VA Pilot Duty
Spring Return		Direction is Selectable with Mounting Position of Actuator: Actuator Face Labeled A is away from Damper or Valve: CCW Spring Return Actuator Face Labeled B is away from Damper or Valve: CW Spring Return
Rated Torque	Power On (Running)	70 lb-in (8 N·m) All Operating Temperatures
	Power Off (Spring Returning)	70 lb-in (8 N·m) All Operating Temperatures
Rotation Range		Maximum Full Stroke: 95° Adjustable Stop: 35° to 95° Maximum Position
Rotation Time for 90 Degrees of Travel	Power On (Running)	150 Seconds Constant for 0 lb-in to 70 lb-in (8 N·m) Load, At All Operating Conditions
	Power Off (Spring Returning)	17 to 25 Seconds for 0 lb-in to 70 lb-in (8 N·m) Load, at Room Temperature 22 Seconds Nominal at Full Rated Load 94 Seconds Maximum with 70 lb-in (8 N·m) Load, at -40°F (-40°C)
Life Cycles		60,000 Full Stroke Cycles with 70 lb-in (8 N·m) Load 1,500,000 Repositions with 70 lb-in (8 N·m) Load
Audible Noise Rating	Power On (Running)	< 35 dBA at 70 lb-in (8 N·m) Load, at a Distance of 39-13/32 in. (1 m)
	Power On (Holding)	< 20 dBA at a Distance of 39-13/32 in. (1 m)
	Power Off (Spring Returning)	< 52 dBA at 70 lb-in (8 N·m) Load, at a Distance of 39-13/32 in. (1 m)
Electrical Connections	Models: GGx-3	48 in. (1.2 m) UL 758 Type AWM Halogen-Free Cable with 18 AWG (0.85 mm ²) Conductors and 0.25 in. (6 mm) Ferrule Ends
	Models: GGA-2	120 in. (3.05 m) UL 444 Type CMP Plenum Rated Cable with 19 AWG (0.75 mm ²) Conductors and 0.25 in. (6 mm) Ferrule Ends
	Auxiliary Switches (-xxC Models)	48 in. (1.2 m) UL 758 Type AWM Halogen-Free Cable with 18 AWG (0.85 mm ²) Conductors and 0.25 in. (6 mm) Ferrule Ends
Conduit Connections		Integral Connectors for 3/8 in. (10 mm) Flexible Metal Conduit
Mechanical Connections	Round Shafts	Range of Sizes: 5/16 in. to 5/8 in. (8 mm to 16 mm)
	Square Shafts	Range of Sizes: 1/4 in. to 1/2 in. (6 mm to 12 mm)
Enclosure Rating		NEMA 2 (IP54) for All Mounting Directions
Ambient Conditions	Standard Operating	-40°F to 140°F (-40°C to 60°C); 90% RH Maximum, Noncondensing
	Storage	-40°F to 185°F (-40°C to 85°C); 95% RH Maximum, Noncondensing
Dimensions		6.33 in. x 3.90 in. x 2.26 in. (160.7 mm x 99 mm x 57.5 mm)

M9208-xxx-x Series Electric Spring-Return Actuators (Continued)

M9208-GGx-x Series Proportional Electric Spring-Return Actuator (Part 2 of 2)		
	United States	UL Listed, CCN XAPX, File E27734; to UL 60730-1A: 2003-08, Ed. 3.1, Automatic Electrical Controls for Household and Similar Use; and UL 60730-2-14: 2002-02, Ed. 1, Part 2, Particular Requirements for Electric Actuators. (Models: All)
	Canada	UL Listed, CCN XAPX7, File E27734; to UL 60730-1:02-CAN/CSA: July 2002, 3rd Ed., Automatic Electrical Controls for Household and Similar Use; and CSA C22.2 No. 24-93 Temperature Indicating and Regulating Equipment (Models: All).
	Europe	CE Mark – Johnson Controls declares that this product is in compliance with the essential requirements and other relevant provisions of the EMC Directive and Low Voltage Directive.
	Australia and New Zealand	RCM Mark, Australia/NZ Emissions Compliant (Models: All)
Shipping Weight		Models: -GGA: 3.43 lb (1.6 kg) Models: -GGC: 3.8 lb (1.7 kg)

M9208-AGx-x Series On/Off and Floating Point Control Electric Spring-Return Actuator (Part 1 of 2)		
Power Requirements	-AGx Models	AC 24 V (AC 19.2 V to 28.8 V) at 50/60 Hz: Class 2 (North America) or Safety Extra-Low Voltage (SELV) (Europe), 7.9 VA Running, 5.5 VA Holding Position DC 24 V (DC 21.6 V to 28.8 V): Class 2 (North America) or SELV (Europe), 3.5 W Running, 1.9 W Holding Position Minimum Transformer Size: 8 VA per Actuator
Input Signal	-AGx Models	AC 19.2 to 28.8 V at 50/60 Hz or DC 24 V +20%/-10%, Class 2 (North America) or SELV (Europe) Minimum Pulse Width: 500 ms
Control Input Impedance	-AGx Models	3,000 Ohm Control Inputs
Auxiliary Switch Rating	-xxC Models	Two SPDT, Double-Insulated Switches with Gold over Silver Contacts: AC 24 V, 50 VA Pilot Duty AC 120 V, 5.8 A Resistive, 1/4 hp, 275 VA Pilot Duty AC 240 V, 5.0 A Resistive, 1/4 hp, 275 VA Pilot Duty
Spring Return		Direction is Selectable with Mounting Position of Actuator: Actuator Face Labeled A is away from Damper or Valve: CCW Spring Return Actuator Face Labeled B is away from Damper or Valve: CW Spring Return
Rated Torque	Power On (Running)	70 lb-in (8 N·m) All Operating Temperatures
	Power Off (Spring Returning)	70 lb-in (8 N·m) All Operating Temperatures
Rotation Range		Maximum Full Stroke: 95° Adjustable Stop: 35° to 95° Maximum Position
Rotation Time for 90 Degrees of Travel	Power On (Running)	150 Seconds Constant for 0 lb-in to 70 lb-in (8-N m) Load, At All Operating Conditions
	Power Off (Spring Returning)	17 to 25 Seconds for 0 lb-in to 70 lb-in (8 N·m) Load, at Room Temperature 22 Seconds Nominal at Full Rated Load 94 Seconds Maximum with 70 lb-in (8 N·m) Load, at -40°F (-40°C)
Life Cycles		60,000 Full Stroke Cycles with 70 lb-in (8 N·m) Load 1,500,000 Repositions with 70 lb-in (8 N·m) Load
Audible Noise Rating	Power On (Running)	< 35 dBA at 70 lb-in (8 N·m) Load, at a Distance of 39-13/32 in. (1 m)
	Power On (Holding)	< 20 dBA at a Distance of 39-13/32 in. (1 m)
	Power Off (Spring Returning)	< 52 dBA at 70 lb-in (8 N·m) Load, at a Distance of 39-13/32 in. (1 m)
Electrical Connections	Models: AGx-3	48 in. (1.2 m) UL 758 Type AWM Halogen-Free Cable with 18 AWG (0.85 mm ²) Conductors and 0.25 in. (6 mm) Ferrule Ends
	Models: AGA-2	120 in. (3.05 m) UL 444 Type CMP Plenum Rated Cable with 19 AWG (0.75 mm ²) Conductors and 0.25 in. (6 mm) Ferrule Ends
	Auxiliary Switches (-xxC Models)	48 in. (1.2 m) UL 758 Type AWM Halogen-Free Cable with 18 AWG (0.85 mm ²) Conductors and 0.25 in. (6 mm) Ferrule Ends
Conduit Connections		Integral Connectors for 3/8 in. (10 mm) Flexible Metal Conduit
Mechanical Connections	Round Shafts	Range of Sizes: 5/16 in. to 5/8 in. (8 mm to 16 mm)
	Square Shafts	Range of Sizes: 1/4 in. to 1/2 in. (6 mm to 12 mm)
Enclosure Rating		NEMA 2 (IP54) for All Mounting Directions

The performance specifications are nominal and conform to acceptable industry standards. For applications at conditions beyond these specifications, consult the local Johnson Controls office. Johnson Controls shall not be liable for damages resulting from misapplication or misuse of its products. © 2019 Johnson Controls. www.johnsoncontrols.com

M9208-xxx-x Series Electric Spring-Return Actuators (Continued)

M9208-AGx-x Series On/Off and Floating Point Control Electric Spring-Return Actuator (Part 2 of 2)		
Ambient Conditions	Standard Operating	-40°F to 140°F (-40°C to 60°C); 90% RH Maximum, Noncondensing
	Storage	-40°F to 185°F (-40°C to 85°C); 95% RH Maximum, Noncondensing
Dimensions	6.33 in. x 3.90 in. x 2.26 in. (160.7 mm x 99 mm x 57.5 mm)	
Compliance 	United States	UL Listed, CCN XAPX, File E27734; to UL 60730-1A: 2003-08, Ed. 3.1, Automatic Electrical Controls for Household and Similar Use; and UL 60730-2-14: 2002-02, Ed. 1, Part 2, Particular Requirements for Electric Actuators. (Models: All)
	Canada	UL Listed, CCN XAPX7, File E27734; to UL 60730-1:02-CAN/CSA: July 2002, 3rd Ed., Automatic Electrical Controls for Household and Similar Use; and CSA C22.2 No. 24-93 Temperature Indicating and Regulating Equipment (Models: All).
	Europe	CE Mark – Johnson Controls declares that this product is in compliance with the essential requirements and other relevant provisions of the EMC Directive and Low Voltage Directive.
	Australia and New Zealand	RCM Mark, Australia/NZ Emissions Compliant (Models: All)
Shipping Weight	Models: -AGA: 3.43 lb (1.6 kg) Models: -AGC: 3.8 lb (1.7 kg)	

M9208-Bxx-3 Series On/Off Electric Spring-Return Actuators (Part 1 of 2)		
Power Requirements	-BGx Models	AC 24 V (AC 18 V to 30 V) at 50/60 Hz: Class 2 (North America) or Safety Extra-Low Voltage (SELV) (Europe), 6.1 VA Running, 1.2 VA Holding Position DC 24 V (DC 21.6 V to 28.8 V): Class 2 (North America) or SELV (Europe), 3.5 W Running, 0.5 W Holding Position Minimum Transformer Size: 7 VA per Actuator
	-BAx Models	AC 120 V (AC 102 V to 132 V) at 60 Hz: 0.05 A Running, 0.03 A Holding Position
	-BDx Models	AC 230 V (AC 198 V to 264 V) at 50/60 Hz: 0.04 A Running, 0.03 A Holding Position
Auxiliary Switch Rating	-xxC Models	Two SPDT, Double-Insulated Switches with Gold over Silver Contacts: AC 24 V, 50 VA Pilot Duty AC 120 V, 5.8 A Resistive, 1/4 hp, 275 VA Pilot Duty AC 240 V, 5.0 A Resistive, 1/4 hp, 275 VA Pilot Duty
Spring Return	Direction is Selectable with Mounting Position of Actuator: Actuator Side A is away from Damper or Valve: CCW Spring Return Actuator Side B is away from Damper or Valve: CW Spring Return	
Rated Torque	Power On (Running)	70 lb-in (8 N·m) All Operating Temperatures
	Power Off (Spring Returning)	70 lb-in (8 N·m) at Standard Operating Temperatures 53 lb-in (6 N·m) at Extended Operating Temperatures
Rotation Range	Maximum Full Stroke: 95° Adjustable Stop: 35 to 95°, Maximum Position	
Rotation Time for 90 Degrees of Travel	Power On (Running)	55 to 71 Seconds for 0 lb-in to 70 lb-in (8 N·m) Load, at All Operating Conditions 60 Seconds Nominal at Full Rated Load (0.25 rpm)
	Power Off (Spring Returning)	13 to 26 Seconds for 0 lb-in to 70 lb-in (8 N·m) Load, at Room Temperature 21 Seconds Nominal at Full Rated Load 39 Seconds Maximum with 70 lb-in (8 N·m) Load at -4°F (-20°C) 108 Seconds Maximum with 53 lb-in (6 N·m) Load at -40°F (-40°C)
Life Cycles	60,000 Full-Stroke Cycles with 70 lb-in (8 N·m) Load	
Audible Noise Rating	Power On (Running)	< 47 dBA at 70 lb-in (8 N·m) Load, at a Distance of 39-13/32 in. (1 m)
	Power On (Holding)	< 20 dBA at a Distance of 39-13/32 in. (1 m)
	Power Off (Spring Returning)	< 52 dBA at 70 lb-in (8 N·m) Load, at a Distance of 39-13/32 in. (1 m)
Electrical Connections	Actuator (All Models)	48 in. (1.2 m) UL 758 Type AWM Halogen-Free Cable with 18 AWG (0.85 mm ²) Conductors and 0.25 in. (6 mm) Ferrule Ends
	Auxiliary Switches (-xxC Models)	48 in. (1.2 m) UL 758 Type AWM Halogen-Free Cable with 18 AWG (0.85 mm ²) Conductors and 0.25 in. (6 mm) Ferrule Ends
Conduit Connections	Integral Connectors for 3/8 in. (10 mm) Flexible Metal Conduit	
Mechanical Connections	Round Shafts	Range of Sizes: 5/16 in. to 5/8 in. (8 mm to 16 mm)
	Square Shafts	Range of Sizes: 1/4 in. to 1/2 in. (6 mm to 12 mm)

The performance specifications are nominal and conform to acceptable industry standards. For applications at conditions beyond these specifications, consult the local Johnson Controls office. Johnson Controls shall not be liable for damages resulting from misapplication or misuse of its products. © 2019 Johnson Controls. www.johnsoncontrols.com

M9208-xxx-x Series Electric Spring-Return Actuators (Continued)

M9208-Bxx-3 Series On/Off Electric Spring-Return Actuators (Part 2 of 2)		
Ambient Conditions	Extended Operating	-40°F to -4°F (-40°C to -20°C); 90% RH Maximum, Noncondensing
	Storage	-40°F to 185°F (-40°C to 85°C); 95% RH Maximum, Noncondensing
Dimensions		6.33 in. x 3.90 in. x 2.26 in. (160.7 mm x 99 mm x 57.5 mm)
Compliance 	United States	UL Listed, CCN XAPX, File E27734; to UL 60730-1A: 2003-08, Ed. 3.1, Automatic Electrical Controls for Household and Similar Use; and UL 60730-2-14: 2002-02, Ed. 1, Part 2, Particular Requirements for Electric Actuators. (Models: All)
	Canada	UL Listed, CCN XAPX7, File E27734; to UL 60730-1:02-CAN/CSA: July 2002, 3rd Ed., Automatic Electrical Controls for Household and Similar Use; and CSA C22.2 No. 24-93 Temperature Indicating and Regulating Equipment (Models: All).
	Europe	CE Mark – Johnson Controls declares that this product is in compliance with the essential requirements and other relevant provisions of the EMC Directive and Low Voltage Directive.
	Australia and New Zealand	RCM Mark, Australia/NZ Emissions Compliant (Models: All)
Shipping Weight		Models: -BGC: 3.75 lb (1.7 kg) Models: -BAC and -BDC: 4.15 lb (1.9 kg)

M9220 Series Electric Spring-Return Actuators

Description

The M9220-xxx-3 actuators are direct-mount, spring-return electric actuators that operate with these available power options:

- AC 24 V at 50/60 Hz or DC 24 V (AGx, BGx, GGx, HGx)
- AC 120 V at 60 Hz (BAX)
- AC 230 V at 50/60 Hz (BDx)

These bidirectional actuators do not require a damper linkage, and are easily installed on dampers with 1/2 in. to 3/4 in. or 12 mm to 19 mm round shafts, or 3/8 in. and 1/2 in. or 10 mm, 12 mm, and 14 mm square shafts using the standard shaft clamp included with the actuator. An optional M9220-600 Jackshaft Coupler Kit is available for 3/4 in. to 1-1/16 in. or 19 mm to 27 mm round shafts, or 5/8 in. and 3/4 in. or 16 mm, 18 mm, and 19 mm square shafts.

A single M9220-xxx-3 Electric Spring-Return Actuator provides a running and spring-return torque of 177 lb·in (20 N·m). Two or three models mounted in tandem deliver twice or triple the torque. Integral line voltage auxiliary switches are available on the -xxC models to indicate end-stop position or to perform switching functions within the selected rotation range.

Refer to the *M9220-xxx-3 Electric Spring-Return Actuators Product Bulletin (LIT-12011057)* for important product application information and single point of contact information.

Features

- Available torques of 177 lb·in (20 N·m) for single actuators, 354 lb·in (40 N·m) for two models, and 531 lb·in (60 N·m) for three models mounted in tandem—offer a selection that is most suitable for the application.
- Reversible mounting design—simplifies installation and enables the actuator to spring return in either direction.
- Electronic stall detection throughout entire rotation range—extends the life of the actuator by deactivating the actuator motor when an overload condition is detected.
- Removable coupler—adapts to a shorter damper shaft.
- Integral 48 in. (1.2 m) halogen-free cables with colored and numbered conductors—simplify field wiring.
- Integral auxiliary switches (xxC Models)—provide one fixed and one adjustable switch point with line voltage capability.
- NEMA 2 (IP54) rated aluminum enclosure—protects the internal components of the actuator from dirt and moisture.
- Easy-to-use locking manual override with auto release and crank storage—allows for manual positioning of the actuator hub.
- Integral connectors for 3/8 in. flexible metal conduit—simplify installation and field wiring.
- Microprocessor-controlled brushless DC motor (-AGx, -GGx, and -HGx types)—provides constant run-time independent of torque.

M9220 Series Electric Spring-Return Actuator



Applications

The M9220-xxx-3 Electric Spring-Return Actuators provide reliable control of dampers and valves in HVAC systems. The M9220-xxx-3 Actuators are available for use with on/off, floating, and proportional controllers.

Repair Information

If the M9220 Series Electric Actuator fails to operate within its specifications, replace the unit. For a replacement actuator, contact the nearest Johnson Controls® representative.

Selection Chart

Code Number	Control Type	Auxiliary Switches	Power Requirements
M9220-AGA-3	Floating	None	AC 24 V at 50/60 Hz or DC 24 V
M9220-AGC-3	Floating	Two	AC 24 V at 50/60 Hz or DC 24 V
M9220-BAA-3	On/Off	None	AC 120 V at 60 Hz
M9220-BAC-3	On/Off	Two	AC 120 V at 60 Hz
M9220-BDA-3	On/Off	None	AC 230 V at 50/60 Hz
M9220-BDC-3	On/Off	Two	AC 230 V at 50/60 Hz
M9220-BGA-3	On/Off	None	AC 24 V at 50/60 Hz or DC 24 V
M9220-BGC-3	On/Off	Two	AC 24 V at 50/60 Hz or DC 24 V
M9220-GGA-3	Proportional	None	AC 24 V at 50/60 Hz or DC 24 V
M9220-GGC-3	Proportional	Two	AC 24 V at 50/60 Hz or DC 24 V
M9220-HGA-3	Proportional with Adjustable Zero and Span	None	AC 24 V at 50/60 Hz or DC 24 V
M9220-HGC-3	Proportional with Adjustable Zero and Span	Two	AC 24 V at 50/60 Hz or DC 24 V

M9220 Series Electric Spring-Return Actuators (Continued)

Accessories

Code Number	Description
DMPR-KC003	7 in. (178 mm) blade pin extension (without bracket) for Johnson Controls direct-mount damper applications (quantity 5) Note: Available with damper and may be ordered separately
M9000-153	Crankarm (quantity 1)
M9000-158	Tandem Mounting Kit used to mount two models of M9220-xxx-3 Series Proportional Electric Spring-Return Actuators (quantity 1)
M9000-170	Remote Mounting Kit, horizontal. Kit includes mounting bracket, M9000-153 crankarm, ball joint, and mounting bolts (quantity 1)
M9000-171	Remote Mounting Kit, Vertical. Kit Includes mounting bracket, M9000-153 crankarm, ball joint, and mounting bolts (quantity 1)
M9000-320	Weather Shield Enclosure - NEMA 3R enclosure for protecting a single M9210/20 Actuator from rain, sleet, or snow (quantity 1)
M9000-400	Jackshaft Linkage Kit. Open-ended design enables clamping onto a jackshaft without requiring access to the ends of the jackshaft (quantity 1)
M9000-519	Valve linkage for mounting M9220 actuator to 2-1/2 to 6 in. flanged ball valves
M9000-604	Replacement Anti-Rotation Bracket Kit (with Screws) for M9220-xxx-3 Series Proportional Electric Spring-Return Actuators (quantity 1)
M9200-100	Threaded Conduit Adapter, 1/2 NPSM, for M9210(20) and M(VA)9208 Series Actuators (quantity 5)
M9220-600	1 in. (25 mm) Jackshaft Coupler Kit (with locking clip) for mounting M9220-xxx-3 Proportional Electric Spring-Return Actuators on dampers with 3/4 in. to 1-1/16 in. or 19 mm to 27 mm round shafts, or 5/8 in. and 3/4 in. or 16 mm, 18 mm, and 19 mm square shafts (quantity 1)
M9220-601	Replacement Coupler Kit (with locking clip) for mounting M9220-xxx-3 Proportional Electric Spring-Return Actuators on dampers with 1/2 in. to 3/4 in. or 12 mm to 19 mm round shafts, or 3/8 in. and 1/2 in. or 10 mm, 12 mm, and 14 mm square shafts (quantity 1)
M9220-602	Replacement Locking Clips for M9220-xxx-3 Proportional Electric Spring-Return Actuators (five per bag)
M9220-603	Adjustable Stop Kit for M9220-xxx-3 Proportional Electric Spring-Return Actuators (quantity 1)
M9220-604	Replacement Manual Override Cranks for M9220-xxx-3 Proportional Electric Spring-Return Actuators (five per bag)
M9220-610	Replacement Shaft Gripper, 10 mm square shaft with locking clip (quantity 1)
M9220-612	Replacement Shaft Gripper, 12 mm square shaft with locking clip (quantity 1)
M9220-614	Replacement Shaft Gripper, 14 mm square shaft with locking clip (quantity 1)

M9220 Series Electric Spring-Return Actuators (Continued)

Dimensions

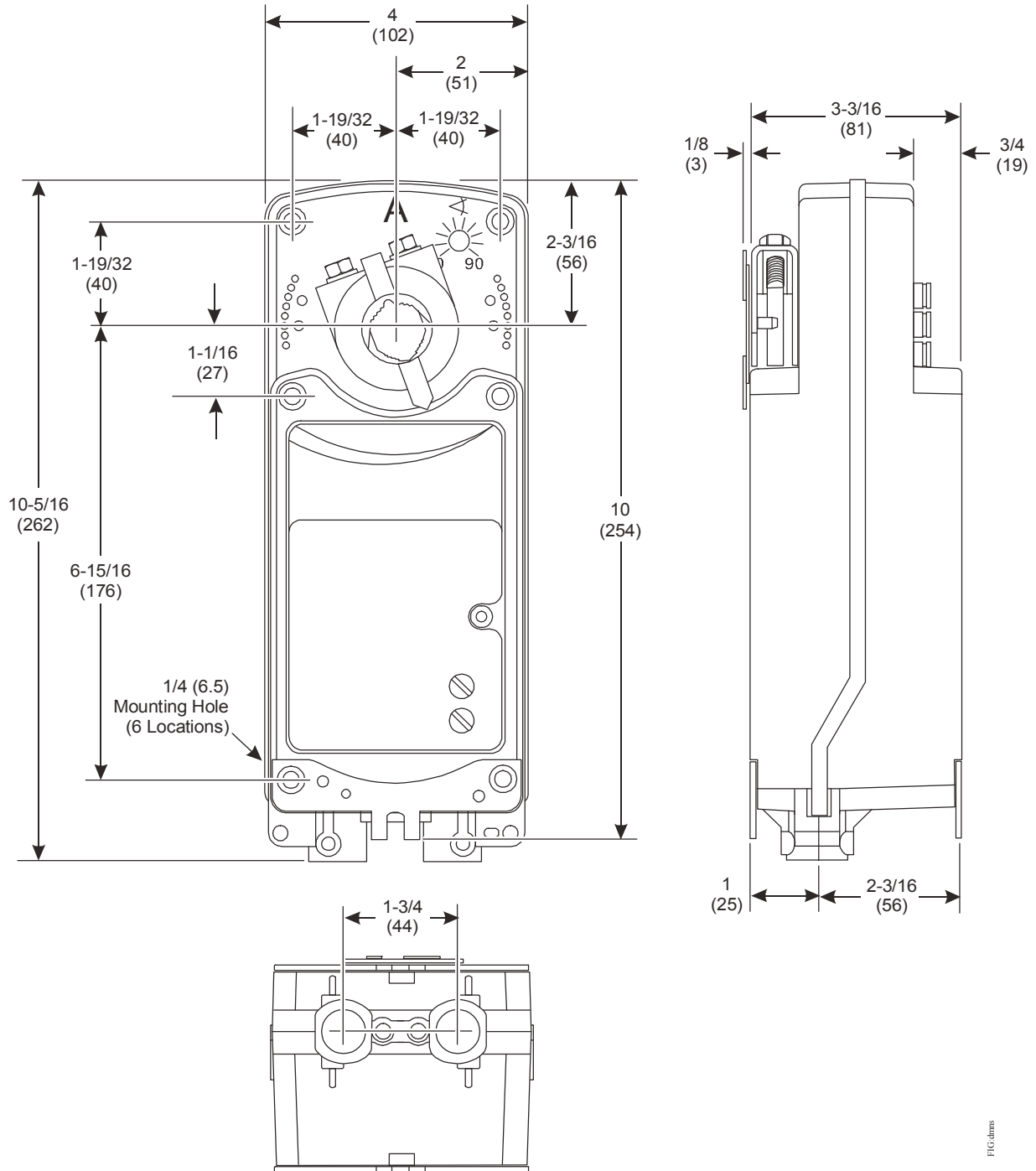

M9220-xxx-3 Electric Spring-Return Actuator Dimensions, in. (mm)

FIG.dams

M9220 Series Electric Spring-Return Actuators (Continued)

Technical Specifications

M9220 Series Electric Spring-Return Actuators (Part 1 of 2)		
Product Codes		M9220-AGx-3 Models: Floating M9220-Bxx-3 Models: On/Off M9220-GGx-3 Models: Proportional M9220-HGx-3 Models: Proportional Adjustable
Power Requirements	AGx, HGx, GGx Models	AC 24 V (19.2 V to 30 V) at 50/60 Hz: Class 2, 15.5 VA running, 7.7 VA holding position; DC 24 V (21.6 V to 26.4 V): Class 2, 6.7 W running, 2.9 W holding position
	BAx Models	AC 120 V (AC 102 to 132 V) at 60 Hz: 0.25 A running, 0.13 A holding position
	BDx Models	AC 230 V (AC 198 to 264 V) at 50/60 Hz: 0.15 A running, 0.09 A holding position
	BGx Models	AC 24 V (19.2 to 30 V) at 50/60 Hz: Class 2, 24.6 VA running, 7.7 VA holding position; DC 24 V (21.6 to 26.4 V): Class 2, 17.6 W running, 2.8 W holding position
Transformer Sizing Requirements	AGx, HGx, GGx Models	20 VA minimum per actuator
	Bxx Models	25 VA minimum per actuator
Input Signal/Adjustments	AGx Models	DC 0 (2) to 10 V or 0 (4) to 20 mA with field furnished 500 Ohm resistor; Switch selectable direct or reverse action with signal increase, 500 ms minimum pulse width
	GGx Models	Factory set DC 0 to 10 V, CW Rotation with signal increase; Selectable DC 0 (2) to 10 V or 0 (4) to 20 mA with field furnished 500 Ohm, 0.25 W minimum resistor; switch selectable direct or reverse action with signal increase
	HGx Models	Factory set DC 0 to 10 V, CW rotation with signal increase; Selectable DC 0 to 10 V or 0 to 20 mA with field furnished 500 Ohm, 0.25 W minimum resistor; Start point programmable DC 0 to 10 V; Span programmable DC 2 to 10 V; Switch selectable direct or reverse action with signal increase
Control Input Impedance	GGx, HGx Models	Voltage Input: 200,000 Ohms; Current Input: 500 Ohms with field furnished 500 Ohm resistor
Feedback Signal	GGx Models	0 (2) to 10 VDC for desired rotation range up to 90°; Corresponds to rotation limits, 1 mA maximum
	HGx Models	0 to 10 VDC for desired rotation range up to 90°; Corresponds to rotation limits, 1 mA maximum
Auxiliary Switch Rating	xxC Models	Two Single-Pole, Double-Throw (SPDT), double-insulated switches with gold flash contacts: AC 24 V, 50 VA Pilot Duty; AC 120 V, 5.8 A resistive, 1/4 hp, 275 VA Pilot Duty; AC 240 V, 5.0 A resistive, 1/4 hp, 275 VA Pilot Duty
Spring Return		Direction is selectable with mounting position of actuator: Side A, actuator face away from Damper for CCW spring return; Side B, actuator face away from Damper for CW spring return
Running and Spring Return Torque		177 lb-in (20 N·m) for a single actuator; 354 lb-in (40 N·m) for two models mounted in tandem 531 lb-in (60 N·m) for three models mounted in tandem
Valid Tandem Combinations		Two M9220-Bxx-3 Three M9220-AGx-3 One M9220-HGx-3 master with one or two M9220-GGX-3 slaves One M9220-GGx-3 master with one or two M9220-GGX-3 slaves
Rotation Range		Adjustable from 30° to 90° CW or CCW with optional M9220-603 Adjustable Stop Kit; mechanically limited to 90°
Rotation Time Power On (Running)	AGx, HGx, GGx Models	150 seconds for 0 lb-in to 177 lb-in (0 N·m to 20 N·m) at all operating conditions; independent of load
	BGx Models	24 to 57 seconds for 0 lb-in to 177 lb-in (0 N·m to 20 N·m) at all operating conditions; 35 seconds nominal at full rated load
Rotation Time Power Off (Spring Returning)	AGx, HGx, GGx Models	20 seconds for 0 lb-in to 177 lb-in (0 N·m to 20 N·m) at room temperature
	BGx Models	11 to 15 seconds for 0 lb-in to 177 lb-in (0 N·m to 20 N·m) at room temperature; 35 seconds maximum for 0 lb-in to 177 lb-in (0 N·m to 20 N·m) at -22°F (-30°C) 130 seconds maximum for 0 lb-in to 177 lb-in (0 N·m to 20 N·m) at -40°F (-40°C)
Cycles		60,000 full stroke cycles; 1,500,000 repositions
Audible Noise Rating (AGx, HGx, GGx Models)	Power On (Running)	< 40 dBA at 39-13/32 in. (1 m)
	Power On (Holding)	< 20 dBA at 39-13/32 in. (1 m)
	Power Off (Spring Returning)	< 55 dBA at 39-13/32 in. (1 m)

M9220 Series Electric Spring-Return Actuators (Continued)

M9220 Series Electric Spring-Return Actuators (Part 2 of 2)		
Audible Noise Rating (BGx Models)	Power On (Running)	< 66 dBA at 39-13/32 in. (1 m)
	Power On (Holding)	< 18 dBA at 39-13/32 in. (1 m)
	Power Off (Spring Returning)	< 66 dBA at 39-13/32 in. (1 m)
Electrical Connections	Actuator (All Models)	48 in. (1.2 m) halogen-free cable with 18 AWG (0.75 mm ²) wire leads
	Auxiliary Switches (xxC Models)	48 in. (1.2 m) halogen-free cable with 18 AWG (0.75 mm ²) wire leads
Conduit Connections		Integral connectors for 3/8 in. (10 mm) flexible metal conduit
Mechanical Connections	Standard Shaft Clamp Included with Actuator	1/2 in. to 3/4 in. or 12 mm to 19 mm diameter round shafts, or 3/8in. and 1/2 in. or 10 mm, 12 mm, and 14 mm square shafts
	Optional M9220-600 Jackshaft Coupler Kit	3/4 in. to 1-1/16 in. or 19 mm to 27 mm diameter round shafts, or 5/8 in. and 3/4 in. or 16 mm, 18 mm, and 19 mm square shafts
Aluminum Enclosure		NEMA 2 (IP54) for all mounting orientations
Ambient Conditions	Operating	-40°F to 131°F (-40°C to 55°C); 90% RH maximum, noncondensing
	Storage	-85°F to 185°F (-65°C to 85°C); 95% RH maximum, noncondensing
Dimensions		See <i>Dimensions</i> .
Compliance 	United States	UL Listed, CCN XAPX, File E27734; to UL 60730-1, Automatic Controls for Household and Similar Use and UL 60730-2-14 Part 2, Particular Requirements for Electric Actuators (Models: All)
	Canada	UL Listed, CCN XAPX7, File E27734; to CAN/CSA E60730-1, Automatic Controls for Household and Similar Use; and CAN/CSA E60730-2-14 Part 2, Particular Requirements for Electric Actuators (Models: All)
	Europe	CE Mark - Johnson Controls declares that this product is in compliance with the essential requirements and other relevant provisions of the EMC Directive and Low Voltage Directive.
	Australia and New Zealand	RCM Mark, Australia/NZ Emission Compliant (Models: All M9220-xGx and M9220-xDx)
Shipping Weight	xGx Models	6.4 lb (2.9 kg)
	BAx and BDx Models	7.6 lb (3.5 kg)

The performance specifications are nominal and conform to acceptable industry standards. For applications at conditions beyond these specifications, consult the local Johnson Controls office. Johnson Controls shall not be liable for damages resulting from misapplication or misuse of its products. © 2019 Johnson Controls. www.johnsoncontrols.com

M9300 Series Electric Non-Spring Return Actuators

Description

The M9300 Series Electric Non-Spring Return Actuators provide control of dampers in HVAC systems. Actuators in this series provide rated torques from 70 lb·in (8 N·m) to 310 lb·in (35 N·m).

The series consists of models for on/off and floating control as well as models with Automatic Signal Input Detection, which allows automatic recognition of input signals for on/off, floating, and proportional control.

These actuators are configured for direct mounting and do not require damper linkage. Actuators can be mounted directly with a universal clamp to a round damper shaft from 3/4 in. (19 mm) up to 1-1/16 in. (27 mm), and to a square damper shaft from 3/8 in. (10 mm) up to 3/4 in. (19 mm).

An accessory crankarm and remote mounting kit are available for applications where the actuator cannot be direct-coupled to the damper shaft. An optional line voltage auxiliary switch kit can be field installed to indicate an end-stop position or perform switching functions within the selected rotation range. The M9300 actuators also feature an optional NEMA 4X/IP66 weather shield for applications in harsh environments.

Refer to the *M9300 Series Electric Non-Spring Return Actuators Product Bulletin (LIT-12012069)* for important product application information.

Features

- models with Automatic Signal Input Detection, on/off, floating, and proportional control with adjustable span and offset
- line voltage on/off and floating models
- high speed on/off and floating models
- easy conversion to valve operation—same actuator used for dampers or valves
- optional accessory kit
- backward compatible auxiliary switch kits and auxiliary potentiometer
- self-calibrating input signal to adjust stroke
- direct-coupled design
- electronic stall detection
- microprocessor-controlled brushless DC motor
- mode configuration switches
- integral cables with colored and numbered conductors
- optional integral 1/2 in. (13 mm) threaded conduit connectors
- plenum-rated models
- small footprint
- NEMA 5/IP54 enclosure
- Underwriters Laboratories Inc.® (UL), CE Mark, and RCM compliance
- manufactured under International Standards Organization (ISO) 9001 quality control standards
- bottom-mounted coupler
- 5-year warranty

M9300 Series Electric Non-Spring Return Actuator without Accessory Switch Kit



M9300 Series Electric Non-Spring Return Actuator with Accessory Switch Kit



Repair Information

If the M9300 Series Electric Non-Spring Return Actuator fails to operate within its specifications, replace the unit. For a replacement electric actuator, contact the nearest Johnson Controls® representative.

M9300 Series Electric Non-Spring Return Actuators (Continued)

Selection Charts

M9300 Series Electric Non-Spring Return Actuators

Code Number	Running Torque	Rotation Time For 90°	Power Supply		Input Signal			Position Feedback				Auxiliary Switches		Electrical Connection		
	lb-in (N·m)	Running (Seconds)	AC/DC 24 V	VA 85 to 264 V	On/Off	Floating	Proportional DC 0 (2) to 10 V (with Adjustable Span and Offset)	DC 0 (2) to 10 V	140 Ω	1 k Ω	2 k Ω	10 k Ω	1 x SPDT, 3 (0.5) A, AC 240 V	2 x SPDT, 3 (0.5) A, AC 240 V	120 in. (3 m) Plenum Cable	48 in. (1 m) Halogen-Free Cable
M9308-AGA-2Z	70 lb-in (8 N·m)	8	X		X	X			X ¹	X ¹	X ¹	X ¹	X ²	X ²	X	
M9308-AUA-2Z	70 lb-in (8 N·m)	8		X	X	X			X ¹	X ¹	X ¹	X ¹	X ²	X ²		X
M9310-AUA-2	90 lb-in (10 N·m)	90		X	X	X			X ¹	X ¹	X ¹	X ¹	X ²	X ²		X
M9310-GUA-2	90 lb-in (10 N·m)	90		X			X	X ³	X ¹	X ¹	X ¹	X ¹	X ²	X ²		X
M9310-HGA-2	90 lb-in (10 N·m)	90	X		X	X	X	X ³	X ¹	X ¹	X ¹	X ¹	X ²	X ²	X	
M9316-AGA-2Z	140 lb-in (16 N·m)	16	X		X	X			X ¹	X ¹	X ¹	X ¹	X ²	X ²		X
M9316-AUA-2Z	140 lb-in (16 N·m)	16		X	X	X			X ¹	X ¹	X ¹	X ¹	X ²	X ²		X
M9320-AUA-2	180 lb-in (20 N·m)	90		X	X	X			X ¹	X ¹	X ¹	X ¹	X ²	X ²		X
M9320-GUA-2	180 lb-in (20 N·m)	90		X			X	X ³	X ¹	X ¹	X ¹	X ¹	X ²	X ²		X
M9320-HGA-2	180 lb-in (20 N·m)	90	X		X	X	X	X ³	X ¹	X ¹	X ¹	X ¹	X ²	X ²		X
M9335-AUA-2	310 lb-in (35 N·m)	150		X	X	X			X ¹	X ¹	X ¹	X ¹	X ²	X ²		X
M9335-GUA-2	310 lb-in (35 N·m)	150		X			X	X ³	X ¹	X ¹	X ¹	X ¹	X ²	X ²		X
M9335-HGA-2	310 lb-in (35 N·m)	150	X		X	X	X	X ³	X ¹	X ¹	X ¹	X ¹	X ²	X ²		X

1. With optional external feedback potentiometer kit (M9300-140, M9300-1K, M9300-2K, or M9000-10K).
2. With optional external auxiliary switch kit (M9300-1 or M9300-2).
3. Feedback is available when 0 (2) to 10 V proportional input is used.

M9300 Series Electric Non-Spring Return Actuators (Continued)

Accessories (Order Separately)

Code Number	Description
DMPR-KC003 ¹	7 in. (178 mm) blade pin extension without bracket for Johnson Controls® direct-mount damper applications
M9000-158	Tandem mounting bracket for mounting two M9335 Series Electric Actuators in damper applications
M9000-322	NEMA 4X/IP66 weather shield kit for Johnson Controls M9102, M9104, M9203, M9208, M9308, and M9310 Series Electric Damper Actuators
M9000-323	NEMA 4X/IP66 weather shield kit for Johnson Controls M9320 and M9335 Series Electric Damper Actuators
M9000-343	NEMA 4X/IP66 weather shield kit for Johnson Controls M9320 and M9335 Series actuators for applications on VG1000 Series Flanged Ball Valves (2-1/2 in. to 6 in.)
M9000-400	Jackshaft linkage kit
M9000-539	Adapter Kit to mount M9316 and M9320 Series Actuators on M9000-53x linkage kits for the operation of VG2000 Series Flanged Control Globe valves
M9000-604	Replacement anti-rotation bracket kit
M9000-606	Position indicator (five per kit)
M9000-700	Universal ball valve linkage kit for mounting VA9308 and VA9310 actuators to other manufacturers ball valves.
M9300-1	External auxiliary switch kit; one single-pole, double-throw (SPDT)
M9300-2	External auxiliary switch kit; two SPDT
M9300-100	Threaded conduit adapters for 1/2 in. (13 mm) electrician's fittings (five per kit)
M9300-100D	Butterfly Valve Mounting Kit for Tandem M9300 Series Non-Spring Return Electric Actuators to 4, 5 and 6 in. (DN 100, 125 & 150)
M9300-100S	Butterfly Valve Mounting Kit for a Single M9300 Series Non-Spring Return Electric Actuator to 2, 3 and 4 in. (DN 50, 80 & 100)
M9300-140	External auxiliary feedback potentiometer, 140 ohm (optional for 140 ohm position feedback)
M9300-200S	Butterfly Valve Mounting Kit for a Single M9300 Series Non-Spring Return Electric Actuator to 8 in. (DN 200)
M9300-1K	External auxiliary feedback potentiometer, 1k ohm (optional for 1k ohm position feedback)
M9300-2K	External auxiliary feedback potentiometer, 2k ohm (optional for 2k ohm position feedback)
M9300-10K	External auxiliary feedback potentiometer, 10k ohm (optional for 10k ohm position feedback)
M9000-151	Remote mounting kit, with crankarm and damper linkage for Johnson Controls M9108, M9116, M9124, and M9300 Series Electric Damper Actuators
M9310-500	Ball valve linkage kit for converting Johnson Controls M9308 and M9310 Series Electric Damper Actuators into VA9308 and VA9310 Series Electric Valve Actuators
M9310-600	Standard coupler kit for Johnson Controls M9308 and M9310 Series Electric Damper Actuators; round 3/8 in. to 3/4 in. (10 mm to 19 mm) and square 3/8 in. to 5/8 in. (10 mm to 16 mm)
M9320-500	Ball valve linkage kit for converting Johnson Controls M9320 and M9335 Series Electric Damper Actuators into VA9320 and VA9335 Series Electric Valve Actuators
M9320-600	Standard coupler kit for Johnson Controls M9316, M9320, M9335 Series Electric Damper Actuators; round 3/4 in. to 1-1/16 in. (19 mm to 27 mm) and square 5/8 in. to 3/4 in. (16 mm to 19 mm)

1. Furnished with the damper and may be ordered separately.

M9300 Series Electric Non-Spring Return Actuators (Continued)

M9300 Dimensions

M9308 and M9310 Series Electric Damper Actuators, Dimensions (without Switch Kit or Potentiometer Kit)

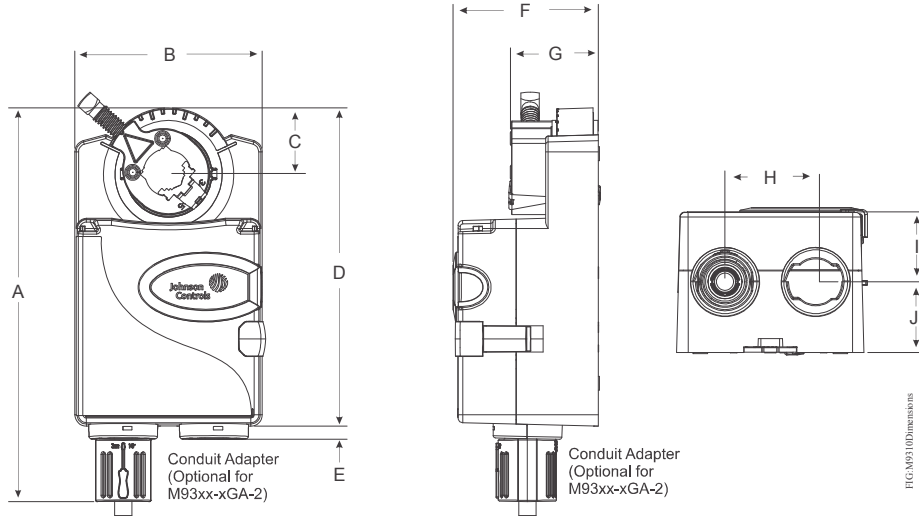

M9308 and M9310 Series Electric Damper Actuators, Dimensions (without Switch Kit or Potentiometer Kit)

Dimensions, in. (mm)	A	B	C	D	E	F	G	H	I	J
	6-21/32 (169)	3-3/16 (81)	1-3/32 (28)	5-13/32 (137)	1/4 (6)	2-7/16 (62)	1-1/2 (38)	1-17/32 (39)	1-3/16 (30)	1-7/32 (31)

M9308 and M9310 Series Electric Damper Actuators, Dimensions (with Switch Kit or Potentiometer Kit)

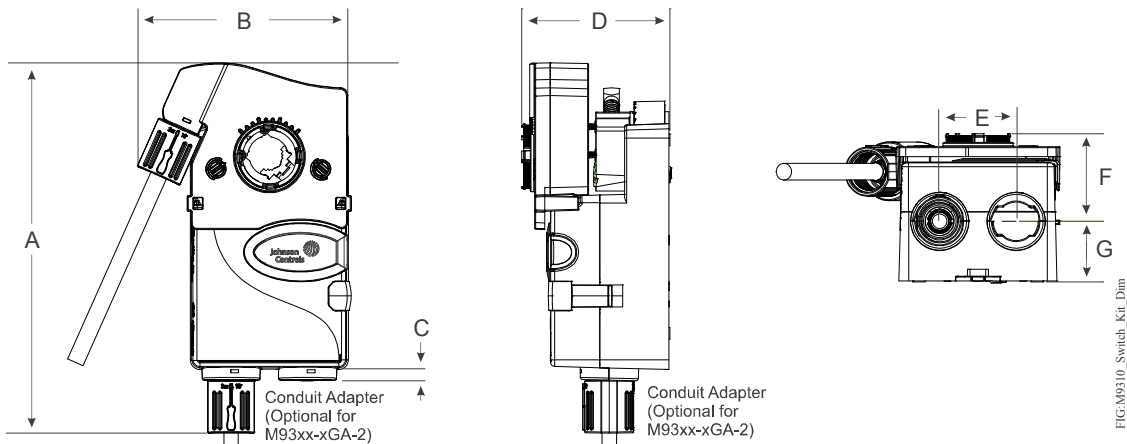

M9308 and M9310 Series Electric Damper Actuators, Dimensions (with Switch Kit or Potentiometer Kit)

Dimensions, in. (mm)	A	B	C	D	E	F	G
	7-3/16 (183)	4-3/16 (106)	1/4 (6)	2-31/32 (75)	1-17/32 (39)	1-3/4 (45)	1-7/32 (31)

M9300 Series Electric Non-Spring Return Actuators (Continued)

**M9320 and M9335 Series Electric Damper Actuators,
Dimensions, in. (mm)**

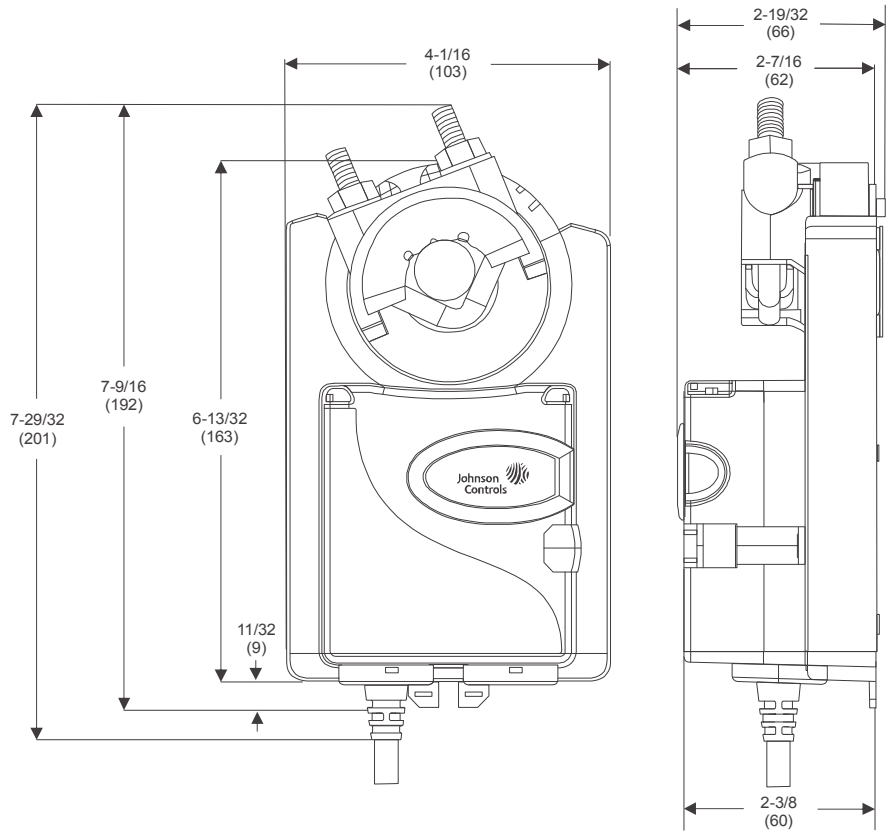

M9300 Series Electric Non-Spring Return Actuators (Continued)

Technical Specifications

M9308-AxA-2Z and M9310-AUA-2 Series Electric Non-Spring Return Actuators

Product Description	M9308-AGA-2Z: Floating and on/off mode	M9308-AUA-2Z: Floating and on/off mode	M9310-AUA-2: Floating and on/off mode
Power Requirements	AC 24 V \pm 20% at 50/60 Hz, Class 2 (North America) or SELV (Europe), 12.7 VA running; DC 24 V \pm 10% Class 2 (North America) or SELV (Europe), 5.7 W running	Nominal AC 120 V at 60 Hz: 0.11 A running	Nominal AC 120 V at 60 Hz: 0.04 A running
Transformer Sizing Requirements	\geq 13 VA	—	—
Input Signal/Adjustments	AC 19.2 V to 28.8 V at 50/60 Hz or DC 24 V \pm 10% Class 2 (North America) or SELV (Europe)	AC 100 V to 240 V (AC 85 V to 264 V) at 50/60 Hz	
Running Torque	70 lb·in (8 N·m)		90 lb·in (10 N·m)
Rotation Range	Mechanically limited 35° to 95° (\pm 3°) in 5° increments		
Rotation Time for 90° of Travel	8 seconds, constant at all operating conditions		90 seconds, constant at all operating conditions
Cycles	60,000 full stroke cycles; 1,500,000 repositions		100,000 full stroke cycles; 2,500,000 repositions
Audible Noise	<45 dBA at 0 lb·in to 70 lb·in (8 N·m) load, at a distance of 39-13/32 in. (1 m)		<35 dBA at 39-13/32 in. (1 m)
Electrical Connections	120 in. (3.05 m) UL 444 type CMP plenum rated cable with 19 AWG (0.75 mm ²) conductors and 0.25 in. (6 mm) ferrule ends	48 in. (1.2 m) halogen free cable with 18 AWG (0.82 mm ²) conductors and 0.25 in. (6mm) ferrule ends	
Conduit Connections	1/2 in. NPSM (13 mm) threaded conduit connectors with M9300-100 Conduit Connector (optional with the M9308-AGA-2Z)		
Ambient Conditions	Operating: -22°F to 140°F (-30°C to 60°C), 95% RH, noncondensing Storage: -40°F to 185°F (-40°C to 85°C), 95% RH, noncondensing		
Enclosure	NEMA 5/IP54		
Shipping Weight	2 lb (0.9 kg)		
Compliance	United States: UL Listed, CCN XAPX, File E27734; to UL 60730-1: Automatic Electrical Controls for Household and Similar Use, Part 1; and UL 60730-2-14: Part 2, Particular Requirements for Electric Actuators. Plenum Rated (UL 2043). Suitable for use in Other Environmental Air Space (Plenum) in accordance with section 300.22 (c) of the National Electrical Code.		
	Canada: UL Listed, CCN XAPX7, File E27734; to CAN/CSA E60730-1:02: Automatic Electrical Controls for Household and Similar Use, Part 1; and CAN/CSA-E60730-2-14, Particular Requirements for Electric Actuators.		
	Europe: CE Mark—Johnson Controls declares that this product is in compliance with the essential requirements and other relevant provisions of the EMC Directive and the Low Voltage Directive.		
	Australia and New Zealand: RCM Mark, Australia/NZ Emissions Compliant		

The performance specifications are nominal and conform to acceptable industry standards. For applications at conditions beyond these specifications, consult the local Johnson Controls office. Johnson Controls shall not be liable for damages resulting from misapplication or misuse of its products. © 2019 Johnson Controls. www.johnsoncontrols.com

M9300 Series Electric Non-Spring Return Actuators (Continued)

M9310-HGA-2 Electric Non-Spring Return Actuator

Product Description	M9310-HGA-2: On/off and floating mode	M9310-HGA-2: Proportional mode
Power Requirements	AC 24 V \pm 20% at 50/60 Hz, Class 2 (North America) or SELV (Europe), 4.7 VA running; DC 24 V \pm 10% Class 2 (North America) or SELV (Europe), 1.3 W running	
Transformer Sizing Requirements	\geq 6.5 VA	
Input Signal/Adjustments	AC 19.2 V to 28.8 V at 50/60 Hz or DC 24 V \pm 10% Class 2 (North America) or SELV (Europe)	DC 0 (2) to 10 V or 0 (4) to 20 mA with field furnished 500 ohm 1/4 W resistor Offset: DC 0 to 10 V SPAN: DC 2 to 10 V
Control Impedance	4.7k ohm	100k ohm
Feedback Signal	—	DC 0 (2) to 10 V
Running Torque	90 lb·in (10 N·m)	
Rotation Range	Mechanically limited 35° to 95° (\pm 3°) in 5° increments	
Rotation Time for 90° of Travel	90 seconds, constant for all operating conditions	
Rotation Time Auto-Calibration	35 seconds	
Cycles	100,000 full stroke cycles; 2,500,000 repositions	
Audible Noise	<35 dBA at 0 lb·in to 90 lb·in (10 N·m) load, at a distance of 39-13/32 in. (1 m)	
Electrical Connections	120 in. (3.05 m) UL 444 type CMP plenum rated cable with 19 AWG cable (0.75 mm ²) conductors and 0.25 in. (6 mm) ferrule ends	
Conduit Connections	1/2 in. NPSM (13 mm) threaded conduit connectors with M9300-100 conduit connector (optional with the M9310-HGA-2)	
Ambient Conditions	Operating: -22°F to 140°F (-30°C to 60°C), 95% RH, noncondensing Storage: -40°F to 185°F (-40°C to 85°C), 95% RH, noncondensing	
Enclosure	NEMA 5/IP54	
Shipping Weight	2 lb (0.9 kg)	
Compliance	<p>United States: UL Listed, CCN XAPX, File E27734; to UL 60730-1: Automatic Electrical Controls for Household and Similar Use, Part 1; and UL 60730-2-14: Part 2, Particular Requirements for Electric Actuators. Plenum Rated (UL 2043). Suitable for use in Other Environmental Air Space (Plenum) in accordance with section 300.22 (c) of the National Electrical Code.</p> <p>Canada: UL Listed, CCN XAPX7, File E27734; to CAN/CSA E60730-1:02: Automatic Electrical Controls for Household and Similar Use, Part 1; and CAN/CSA-E60730-2-14, Particular Requirements for Electric Actuators.</p> <p>Europe: CE Mark—Johnson Controls declares that this product is in compliance with the essential requirements and other relevant provisions of the EMC Directive and the Low Voltage Directive.</p> <p>Australia and New Zealand: RCM Mark, Australia/NZ Emissions Compliant</p>	



M9300 Series Electric Non-Spring Return Actuators (Continued)

M9316-AxA-2Z Non-Spring Return Actuator

Product Description	M9316-AGA-2Z: On/off and floating mode	M9316-AUA-2Z: On/off and floating mode
Power Requirements	AC 24 V \pm 20% at 50/60 Hz, 11.6 VA Running; DC 24 V \pm 10%, 5.4 W Running; Class 2 (North America) or SELV (Europe)	Nominal AC 120 V at 60 Hz, 0.1 A Running
Transformer Sizing Requirements	\geq 12VA	—
Input Signal/Adjustments	AC 19.2 V to 28.8 V at 50/60 Hz or DC 24 V \pm 10% Class 2 (North America) or SELV (Europe)	AC 100 V to 240 V (AC 85 to 264 V) at 50/60 Hz
Control Impedance	100k ohm	100k ohm
Feedback Signal	—	—
Running Torque	144 lb·in (16 N·m)	
Rotation Range	Mechanically limited 35 to 95° (\pm 3°) in 5° increments	
Rotation Time for 90° of Travel	16 seconds, constant for all operating conditions	
Rotation Time Auto-Calibration	16 seconds	
Cycles	60,000 full stroke cycles; 1,500,000 repositions	
Audible Noise	<55 dBA at 0 lb·in to 144 lb·in (16 N·m) load, at a distance of 39-13/32 in. (1 m)	
Electrical Connections	48in. (1.2 m) halogen free cable with 18AWG (0.82 mm ²) conductors and 0.25 in. (6 mm) ferrule ends	
Conduit Connections	1/2 in. NPSM (13 mm) threaded conduit connectors with M9300-100 conduit connector (optional with the M9316-AGA-2Z)	
Ambient Conditions	Operating: -22°F to 140°F (-30°C to 60°C), 95% RH, noncondensing Storage: -40°F to 185°F (-40°C to 85°C), 95% RH, noncondensing	
Enclosure	NEMA 5/IP54	
Shipping Weight	3 lb (1.36 kg)	
Compliance	<p>United States: UL Listed, CCN XAPX, File E27734; to UL 60730-1: Automatic Electrical Controls for Household and Similar Use, Part 1; and UL 60730-2-14: Part 2, Particular Requirements for Electric Actuators. Plenum Rated (UL 2043). Suitable for use in Other Environmental Air Space (Plenum) in accordance with section 300.22 (c) of the National Electrical Code.</p> <p>Canada: UL Listed, CCN XAPX7, File E27734; to CAN/CSA E60730-1:02: Automatic Electrical Controls for Household and Similar Use, Part 1; and CAN/CSA-E60730-2-14, Particular Requirements for Electric Actuators.</p> <p>Europe: CE Mark—Johnson Controls declares that this product is in compliance with the essential requirements and other relevant provisions of the EMC Directive and the Low Voltage Directive.</p> <p>Australia and New Zealand: RCM Mark, Australia/NZ Emissions Compliant</p>	



M9300 Series Electric Non-Spring Return Actuators (Continued)

M93xx-GUA-2 Non-Spring Return Actuator

Product Description	M9310-GUA-2: Proportional mode	M9320-GUA-2: Proportional mode	M9335-GUA-2: Proportional mode
Power Requirements	Nominal AC 120 V at 60 Hz: 0.05 A running	Nominal AC 120 V at 60 Hz: 0.05 A running	Nominal AC 120 V at 60 Hz: 0.06 A running
Transformer Sizing Requirements	—		
Input Signal/Adjustments	AC 100...240 V (AC 85...264 V) at 50/60 Hz		
Feedback Signal	DC 0 (2) to 10 V		
Running Torque	90 lb·in (10 N·m)	180 lb·in (20 N·m)	310 lb·in (35 N·m)
Rotation Range	Mechanically limited 35° to 95° (±3°) in 5° increments		
Rotation Time for 90° of Travel	90 seconds, constant at all operating conditions		150 seconds, constant at all operating conditions
Cycles	100,000 full stroke cycles; 2,500,000 repositions		30,000 full stroke cycles; 750,000 repositions
Audible Noise	<35 dBA at 0 lb·in to 90 lb·in (10 N·m) load, at a distance of 39-13/32 in. (1 m).	<45 dBA at rated load, at a distance of 39-13/32 in. (1 m).	
Electrical Connections	48 in. (1.2 m) halogen free cable with 18 AWG (0.82 mm ²) conductors and 0.25 in. (6mm) ferrule ends		
Conduit Connections	1/2 in. NPSM (13 mm) threaded conduit connectors with M9300-100 Conduit Connector		
Ambient Conditions	Operating: -22°F to 140°F (-30°C to 60°C), 95% RH, noncondensing Storage: -40°F to 185°F (-40°C to 85°C), 95% RH, noncondensing		
Enclosure	NEMA 5/IP54		
Shipping Weight	2 lb (0.9 kg)	3 lb (1.36 kg)	
Compliance	<p>United States: UL Listed, CCN XAPX, File E27734; to UL 60730-1: Automatic Electrical Controls for Household and Similar Use, Part 1; and UL 60730-2-14: Part 2, Particular Requirements for Electric Actuators. Plenum Rated (UL 2043). Suitable for use in Other Environmental Air Space (Plenum) in accordance with section 300.22 (c) of the National Electrical Code.</p> <p>Canada: UL Listed, CCN XAPX7, File E27734; to CAN/CSA E60730-1:02: Automatic Electrical Controls for Household and Similar Use, Part 1; and CAN/CSA-E60730-2-14, Particular Requirements for Electric Actuators.</p> <p>Europe: CE Mark—Johnson Controls declares that this product is in compliance with the essential requirements and other relevant provisions of the EMC Directive and the Low Voltage Directive.</p> <p>Australia and New Zealand: RCM Mark, Australia/NZ Emissions Compliant</p>		

M9300 Series Electric Non-Spring Return Actuators (Continued)

M9320 and M9335 Series Electric Non-Spring Return Actuators (Part 1 of 2)

Product Description	M9320-HGA-2 and M9335-HGA-2		M9320-AUA-2 and M9335-AUA-2
	On/off and floating mode	Proportional mode	On/off and floating mode
Power Requirements	AC 24 V (AC 19.2 V to 28.8 V) at 50/60 Hz, Class 2 (North America) or SELV (Europe) M9320-HGA-2: 6.6 VA running M9335-HGA-2: 6.4 VA running DC 24 V (DC 21.6 to 26.4 V) Class 2 (North America) or SELV (Europe) M9320-HGA-2: 2.2 W running M9335-HGA-2: 2.2 W running		Nominal AC 120 V at 60 Hz M9320-AUA-2: 0.05 A running M9335-AUA-2: 0.05 A running
Transformer Sizing Requirements	≥7 VA		—
Input Signal/Adjustments	AC 19.2 V to 28.8 V at 50/60 Hz or DC 24 V ±10% Class 2 (North America) or SELV (Europe)	DC 0 (2) to 10 V or 0 (4) to 20 mA with field furnished 500 ohm 1/4 W resistor Offset: DC 0 to 10 V Span: DC 2 to 10 V	AC 100 V to 240 V (AC 85 to 264 V) at 50/60 Hz
Control Impedance	4.7k ohm	100k ohm	—
Feedback Signal	—	DC 0 (2) to 10 V	—
Running Torque	M9320-HGA-2 and M9320-AUA-2: 180 lb·in (20 N·m) M9335-HGA-2 and M9335-AUA-2: 310 lb·in (35 N·m)		
Rotation Range	Mechanically limited 35° to 95° (±3°) in 5° increments		
Rotation Time for 90° of Travel	M9320-HGA-2 and M9320-AUA-2: 90 seconds; constant for all operating conditions M9335-HGA-2 and M9335-AUA-2: 150 seconds; constant for all operating conditions		
Rotation Time Auto-Calibration	M9320-HGA-2 and M9320-AUA-2: 35 seconds M9335-HGA-2 and M9335-AUA-2: 75 seconds		
Cycles	M9320-HGA-2 and M9320-AUA-2: 100,000 full stroke cycles; 2,500,000 repositions M9335-HGA-2 and M9335-AUA-2: 30,000 full stroke cycles; 750,000 repositions		
Audible Noise	<45 dBA at maximum load, at a distance of 39-13/32 in. (1 m)		
Electrical Connections	48 in. (1.2 m) halogen-free cable with 18 AWG (0.82 mm ²) conductors and 1/4 in. (6 mm) ferrule ends		
Conduit Connections	Optional 1/2 in. NPSM (13 mm) threaded conduit connectors with M9300-100 conduit connector (optional with M93xx-HGA-2 models)		
Mechanical Connections	Round: 3/4 in. to 1-1/16 in. (19 mm to 27 mm) Square: 5/8 in. to 3/4 in. (16 mm to 19 mm)		
Ambient Conditions	Operating: -22°F to 140°F (-30°C to 60°C), 95% RH, noncondensing Storage: -40°F to 185°F (-40°C to 85°C), 95% RH, noncondensing		
Enclosure	NEMA 5/IP54		

M9300 Series Electric Non-Spring Return Actuators (Continued)

M9320 and M9335 Series Electric Non-Spring Return Actuators (Part 2 of 2)

	<p>United States: UL Listed, CCN XAPX, File E27734; to UL 60730-1: Automatic Electrical Controls for Household and Similar Use, Part 1; and UL 60730-2-14: Part 2, Particular Requirements for Electric Actuators.</p> <p>Canada: UL Listed, CCN XAPX7, File E27734; to CAN/CSA E60730-1:02: Automatic Electrical Controls for Household and Similar Use, Part 1; and CAN/CSA-E60730-2-14, Particular Requirements for Electric Actuators.</p>
	<p>Europe: CE Mark—Johnson Controls declares that this product is in compliance with the essential requirements and other relevant provisions of the EMC Directive and the Low Voltage Directive. IEC 60730-1: Automatic Electrical Controls for Household and Similar Use, Part 1: General Requirements and IEC 60730-2-14, Automatic Electrical Controls for Household and Similar Use; Part 2—Particular Requirements for Electric Actuators</p>
	<p>Australia and New Zealand: RCM Mark, Australia/NZ Emissions Compliant</p>
Shipping Weight	3 lb (1.36 kg)

M9000-3xx Series Weather Shield Enclosures

Description

The M9000-3xx Series Weather Shield Enclosures are cost-effective and durable weather shields designed to provide a degree of protection for a single Johnson Controls® M(VA)9000 Series Electric Actuator used in control damper, ball valve, and iron flanged valve applications. These weather shield enclosures are manufactured to National Electrical Manufacturers' Association (NEMA) specifications, and protect the electric actuator from corrosion, rain, freezing rain, sleet, and snow. The enclosure can be mounted indoors or outdoors; however, the enclosure may not prevent externally formed ice from restricting the motion of the rotary shaft.

Each enclosure is constructed of impact-grade plastic that provides excellent impact resistance. The cover features ultraviolet (UV) inhibitors that extend service life by preventing the cover from becoming brittle or damaged by the sun or other environmental elements. The transparent cover provides an unobstructed view of the electric actuator without having to disassemble the enclosure. An appliance cord in the M9000-310 and M9000-330 Weather Shield Enclosures enable control wiring installation, and a form-fitting seal prevents water or moisture from entering the unit and damaging the actuator.

Refer to the *M9000-3xx Series Weather Shield Enclosures Product Bulletin (LIT-1201704)* for important product application information.

Features

- Durable construction—provides a degree of protection from the elements for a single Johnson Controls M(VA)9000 Series Electric Actuator used in control damper, ball valve, and iron flanged valve applications.
- Fully enclosed design—protects the electric actuator from corrosion, rain, freezing rain, sleet, and snow.
- Impact-grade plastic enclosure—provides impact resistance.
- Cover constructed using UV inhibitors—extends service life by preventing the cover from becoming brittle or damaged by the sun or other environmental elements.
- Transparent cover—allows the electric actuator to be fully viewable without having to disassemble the enclosure.
- Appliance cord (M9000-310 and M9000-330 Models)—facilitates control wiring installation.
- Strain relief conduit fittings—protect the electric actuator from damage by preventing tension on the electrical connection.

M9000-3xx Series Weather Shield Enclosures Mounted on a Control Damper, Flanged Ball Valve, Threaded Ball Valve, and Flanged Cast Iron Valve



Repair Information

If the M9000-3xx Series Weather Shield Enclosure fails to operate within its specifications, replace the unit. For a replacement weather shield enclosure, contact the nearest Johnson Controls representative.

Selection Chart

Code Number	Enclosure Protection Rating	Application				Spring Return Actuators						Non-Spring Return Actuators																
		Dampers	VG2000 Flanged Globe Valves	VG1000 Threaded Ball Valves	VG1000 Flanged Ball Valves	M9203	M9205	M9208	M9220	VA9203	VA9208	M9102	M9104	M9106	M9108	M9109	M9116	M9124	M9132	M9308	M9310	M9320	M9335	VA9104	VA9308	VA9310		
M9000-310 ¹	NEMA 3R, IP32	X	X											X	X	X	X	X	X									
M9000-320 ¹	NEMA 3R, IP32	X	X					X																				
M9000-322 ¹	NEMA 4X, IP66	X				X	X	X			X	X								X	X							
M9000-323 ¹	NEMA 4X, IP66	X																				X	X					
M9000-330 ¹	NEMA 5, IP54				X											X	X											
M9000-340 ¹	NEMA 5, IP54				X			X																				
M9000-342 ¹	NEMA 4X, IP66			X					X	X														X	X	X		

1. Kit includes one enclosure base and seal assembly, one cover and gasket, and all necessary mounting hardware. One weather shield enclosure is required per electric actuator.

M9000-3xx Series Weather Shield Enclosures (Continued)

Technical Specifications

M9000-3xx Series Weather Shield Enclosures		
Enclosure	M9000-310, M9000-320, M9000-330, M9000-340	Impact-grade ABS plastic
	M9000-322, M9000-323, M9000-342	UV resistant polycarbonate plastic
Enclosure Seal		Nitrile
Cover	M9000-310, M9000-320, M9000-330, M9000-340	Transparent impact-grade ABS plastic with UV inhibitors
	M9000-322, M9000-323, M9000-342	Transparent UV resistant polycarbonate plastic
Cover Gasket	M9000-310, M9000-320, M9000-330, M9000-340	Neoprene
	M9000-322, M9000-323, M9000-342	Polyurethane
Enclosure Protection Rating	M9000-310	NEMA 3R, IP32
	M9000-320	NEMA 3R, IP32
	M9000-330	NEMA 5, IP54
	M9000-340	NEMA 5, IP54
	M9000-322	NEMA 4X, IP66
	M9000-323 M9000-342	NEMA 4X, IP66
Weather Shield Enclosure Ambient Storage Temperature Limits		-40 to 176°F (-40 to 80°C)
Electrical Connections		Strain relief conduit fittings with 1/2 in. (13 mm) National Pipe Straight Mechanical (NPSM) exit
Appliance Cord (M9000-310 and M9000-320)		6 conductor, 18 AWG wire gauge, 43 in. (110 cm)
Shipping Weight	M9000-310	2.0 lb (0.9 kg)
	M9000-320	3.3 lb (1.5 kg)
	M9000-322	4.2 lb (1.9 kg)
	M9000-323	4.2 lb (1.9 kg)
	M9000-330	3.2 lb (1.45 kg)
	M9000-340	4.2 lb (1.9 kg)
	M9000-342	4.2 lb (1.9 kg)

Rotary Actuator Accessories

Direct Mount Actuator Accessories (Part 1 of 4)

	Code Number	Description	Qty	Non-Spring Return				Spring Return			
				M(VA)9104(6)-AGx-2Nxx	M9102(4)-xGA-xS	M9106(9)-xGx-2	M(VA)9308/9310	M(VA)9316/9320/9335	M(VA)9203	M(VA)9208	M9220
VAV Accessories	CBL-2000-1	20 in. wire harness, actuator/transmitter to controller	1	■							
	CBL-2000-2	20 in. cable, actuator/transmitter to controller, plenum rated	1	■							
	CBL-2000-3	72 in. cable, actuator/transmitter To controller, plenum rated	1	■							
	DPT-2015-0	Differential pressure transmitter, 0 to 1-1/2 in. W.C. (0 to 374 Pa.)	1	■							
Shaft Couplers / Position Indicators	M9000-606	Position indicators	5				■		■	■	
	M9000-611	Position indicators	5								■
	M9000-154	Jackshaft coupler kit, M9108 (16) (24) (32) Series (Ø 1 in.)	1								
	M9203-601	Standard coupler kit, M9203 Series (Ø 1/4 to 1/2 in.) (□ 1/4 to 5/16 in.)	1						■		
	M9203-602	Retainer for M9203 coupler	5						■		
	M9208-601	Standard coupler kit, M9208 Series (Ø 5/16 to 5/8 in.) (□ 1/4 to 1/2 in.)	1								■
	M9208-600	Large coupler kit, M9208 Series (Ø 1/2 to 3/4 in.) (□ 3/8 to 9/16 in.)	1							■	
	M9220-601	Standard coupler kit M9220 Series (1/2 to 3/4 in.) (□ 3/8 to 1/2 in.)	1								■
	M9220-600	Jackshaft coupler kit, M9220 Series (3/4 to 1-1/16 in.) (□ 5/8 to 3/4 in.)	1								■
	M9220-610	10 mm square shaft adapter with retainer	1								■
	M9220-612	12 mm square shaft adapter with retainer	1								■
	M9220-614	14 mm square shaft adapter with retainer	1								■
	M9208-602	Retainer for M9208 coupler	5							■	
	M9220-602	Retainer for M9220 coupler	5								■
	M9310-600	Damper Shaft Adaptor for VA9300 actuators	1				■				
Mounting Brackets	M9000-152	Reinforcement plate for mounting to thin sheet metal	1								■
	M9000-158	Tandem mounting bracket	1								■
	M9000-160	Anti-rotation bracket	1			■					
	M9000-604	Anti-rotation bracket	1				■		■	■	■
	M9300-100D	Butterfly Valve Mounting Kit for Tandem M9300 Series Non-Spring Return Electric Actuators to 4, 5 and 6 in. (DN 100, 125 & 150)	1					■			
	M9300-100S	Butterfly Valve Mounting Kit for a Single M9300 Series Non-Spring Return Electric Actuator to 2, 3 and 4 in. (DN 50, 80 & 100)	1					■			
M9300-200S	Butterfly Valve Mounting Kit for a Single M9300 Series Non-Spring Return Electric Actuator to 8 in. (DN 200)	1					■				

Rotary Actuator Accessories (Continued)

Direct Mount Actuator Accessories (Part 2 of 4)

	Code Number	Description	Qty	Non-Spring Return				Spring Return			
				M(VA)9104(6)-AGx-2Nxx	M9102(4)-xGA-xS	M9106(9)-xGx-2	M(VA)9308/9310	M(VA)9316/9320/9335	M(VA)9203	M(VA)9208	M9220
Damper Linkages / Accessories	DMPR-KC003	Blade pin extension (Ø 1/2 x 7 in.) for D1300 dampers Not used with VA9308, VA9320, VA9335	1			■	■	■	■	■	■
	DMPR-KC054	Damper blade arm for D1300 dampers	1							■	■
	DMPR-KC100	Damper blade linkage for D1300 dampers	1							■	■
	DMPR-KC102	Damper push rod, Ø 5/16 x 48 in. length	1							■	■
	DMPR-KC254	Damper mount linkage kit for D1300 dampers	1								
	DMPR-KC260	Damper mount linkage kit for D1300 dampers	1								■
	DMPR-KC300	Ball joint for Ø 5/16 in. rod, 1/4-20 x 9/16 in. thread mount	10			■					
	M9000-150	Damper mount linkage kit for D1300 dampers	1								
	M9000-151	Remote mounting kit with crankarm and damper linkage	1				■	■			
	M9000-153	Crankarm kit	1								■
	M9000-170	Remote mounting kit (horizontal) with crankarm	1								■
	M9000-171	Remote mounting kit (vertical) with crankarm	1								■
	M9000-270	Remote mounting kit (horizontal) with crankarm and damper linkage for D1300 dampers	1								■
	M9000-271	Remote mounting kit (vertical) with crankarm and damper linkage for D1300 dampers	1								■
	M9000-400	Jackshaft mounting kit, Ø 1/2 to 1.05 in.	1				■	■		■	■
	M9000-402	Replacement hardware for M9000-400 jackshaft mounting kit	1							■	■
	M9000-605	Ball joint for Ø 1/4 or 5/16 in. rods, 5/16-24 x 33/64 in. thread mount	5						■	■	■
	M9203-100	Remote mounting kit with crankarm	1						■		
	M9203-110	Universal mounting kit	1						■		
	M9203-115	Universal mounting kit with crankarm	1						■		
	M9203-150	Crankarm kit	1						■		
	M9203-250	Remote mounting kit with crankarm and damper linkage for D1300 dampers	1						■		
	M9208-100	Remote mounting kit with crankarm	1							■	
	M9208-150	Crankarm kit	1							■	
	M9208-250	Remote mounting kit with crankarm and damper linkage for D1300 dampers	1							■	
	M9220-605	Ball joint for M8x1.25 threaded rod, M8x1.25 x 16.5 mm thread mount	5								■

Rotary Actuator Accessories (Continued)

Direct Mount Actuator Accessories (Part 3 of 4)

	Code Number	Description	Qty	Non-Spring Return				Spring Return			
				M(VA)9104(6)-AGx-2Nxx	M9102(4)-xGA-xS	M9106(9)-xGx-2	M(VA)9308/9310	M(VA)9316/9320/9335	M(VA)9203	M(VA)9208	M9220
Valve Linkages	M9000-155	Manual handle	1								
	M9000-518	Ball valve linkage for non-spring return, 2-1/2 to 6 in. VG1000 flanged valves with 11 mm square stem	1								
	M9000-519	Ball valve linkage for spring return, 2-1/2 to 6 in. VG1000 flanged valves with 11 mm square stem	1								■
	M9000-530	Linkage for 2-1/2 in. flanged iron globe valves for single actuator mounting	1				■ ¹				■
	M9000-531	Linkage for 3 in. flanged iron globe valves for single actuator mounting	1				■ ¹				■
		Linkage for 4 in. flanged iron globe valves for single actuator mounting	1				■ ¹				■
	M9000-532	Linkage for 3 in. flanged iron globe valves for tandem actuator mounting	1				■ ¹				■
		Linkage for 4 in. flanged iron globe valves for tandem actuator mounting	1				■ ¹				■
	M9000-533	Linkage for 5 in. flanged iron globe valves for single actuator mounting	1				■ ¹				■
	M9000-534	Linkage for 5 in. flanged iron globe valves for tandem actuator mounting	1				■ ¹				■
	M9000-535	Linkage for 6 in. flanged iron globe valves for single actuator mounting	1				■ ¹				■
	M9000-536	Linkage for 6 in. flanged iron globe valves for tandem actuator mounting	1				■ ¹				■
	M9000-537	Linkage for 4 in. flanged iron globe valves for tandem actuator mounting	1				■ ¹				■
	M9000-539	Adapter for M9000-53x linkages						■			
	M9000-551	Ball valve linkage, 1/2 to 1 in. hot/chilled water applications	1		■						
	M9000-560	Ball valve linkage, 1/2 to 2 in. hot/chilled water applications	1						■	■	
	M9000-561	Thermal barrier	1		■		■		■	■	
	M9000-607	Position indicators, VA9203 and VA9208 Series	5								
	M9000-610	Tandem actuator adapter kit for VG2000 Series iron globe valve linkages	1								■
	M9310-500	Ball valve linkage kit for M9310 on VG1000 Series valves	1				■				
M9000-700	Universal Ball Valve Linkage Kit	1	■	■		■		■			
Weather Shields	M9000-310	Weather shield NEMA 3R, control dampers and VG2000 Series iron globe valve linkages, non-spring return	1			■					
	M9000-320	Weather shield NEMA 3R, control dampers and VG2000 Series iron globe valve linkages, spring return	1								■
	M9000-322	Weather shield, NEMA 4X (IP66), control dampers	1	■	■		■		■	■	
	M9000-323	Weather shield, NEMA 4X (IP66), control dampers	1				■				
	M9000-330	Weather shield NEMA 3R, VG1000 Series ball valves with M9000-518 linkage, non-spring return	1								
	M9000-340	Weather shield NEMA 3R, VG1000 Series ball valves with M9000-517 or M9000-519 linkage, spring return	1								■
	M9000-342	Weather shield, NEMA 4X (IP66), 1/2 to 2 in. VG1000 Series ball valves	1	■	■		■		■	■	
	M9000-343	Weather shield, NEMA 4X (IP66), 2-1/2" to 6 in. VG1000 Series ball valves	1				■				

1. Adapter kit M9000-539 is required.

Rotary Actuator Accessories (Continued)

Direct Mount Actuator Accessories (Part 4 of 4)

	Code Number	Description	Qty	Non-Spring Return				Spring Return			
				M(VA)9104(6)-AGx-2Nxx	M9102(4)-xGA-xS	M9106(9)-xGx-2	M(VA)9308/9310	M(VA)9316/9320/9335	M(VA)9203	M(VA)9208	M9220
Switch Kit	M9300-2	Auxiliary Switch Kit 2x SPDT	1				■	■			
Feedback Kit	M9300-1K	Potentiometer Feedback Kit 1k Ohm	1				■	■			
	M9300-2K	Potentiometer Feedback Kit 2k Ohm	1				■	■			
	M9300-10K	Potentiometer Feedback Kit 10k Ohm	1				■	■			
	M9300-140	Potentiometer Feedback Kit 140 Ohm	1				■	■			
Adj. Stops	M9203-603	Adjustable stop kit	1						■		
	M9208-603	Adjustable stop kit	1							■	
	M9220-603	Adjustable stop kit	1								■
Wiring Accessories	M9000-105	Pluggable 3-terminal block	1			■					
	M9000-106	Pluggable 4-terminal block	1			■					
	M9104-100	Conduit adapter for 3/8 in. flexible metal conduit	10		■						
	M9200-100	Threaded conduit adapters for 1/2 in. electrician's fittings	5								■
	M9300-100	Threaded conduit adapters for 1/2 in. electrician's fittings	5				■			■	
Tools	M9220-604	Manual crank, long, crank radius 2-13/16 in. (75 mm)	5							■	■
	M9208-605	Manual crank, short, crank radius 1-13/16 in. (46.5 mm)	5							■	
Miscellaneous	M9000-103	Transformer, 14 VA Class 2, 120 to 24 VAC 60 Hz	1				■		■		
	M9000-104	Transformer, 14 VA Class 2, 230 to 24 VAC 60 Hz	1				■		■		
	Y63T22-0	Transformer, 50 VA Class 2, 120/208/240 to 24 VAC 60 Hz, box mounting	1	■	■	■	■		■	■	■
	Y63T31-0	Transformer, 50 VA Class 2, 120/208/240 to 24 VAC 60 Hz, foot/box mounting	1	■	■	■	■		■	■	■
	Y64T15-0	Transformer, 92 VA Class 2, 120/208/240 to 24 VAC 60 Hz, foot mounting	1	■	■	■	■		■	■	■
	Y64T21-0	Transformer, 92 VA Class 2, 120/208/240 to 24 VAC 60 Hz, box mounting	1	■	■	■	■		■	■	■
	Y64T22-0	Transformer, 92 VA Class 2, 120/208/240 to 24 VAC 60 Hz, box mounting	1	■	■	■	■		■	■	■
	Y65A13-0	Transformer, 40 VA Class 2, 120 to 24 VAC 60 Hz, foot mounting	1	■	■	■	■		■	■	■
	Y65A21-0	Transformer, 40 VA Class 2, 120 to 24 VAC 60 Hz, box mounting	1	■	■	■	■		■	■	■
	Y65G13-0	Transformer, 40 VA Class 2, 24 to 24 VAC 60 Hz isolation, foot mounting	1	■	■	■	■		■	■	■
	Y65S13-0	Transformer, 40 VA Class 2, 208/240 to 24 VAC 60 Hz, foot mounting	1	■	■	■	■		■	■	■
	Y66T12-0	Transformer, 75 VA Class 2, 120/208/240 to 24 VAC 60 Hz, foot mounting	1	■	■	■	■		■	■	■
Y66T13-0	Transformer, 75 VA Class 2, 120/208/240 to 24 VAC 60 Hz, foot mounting	1	■	■	■	■		■	■	■	

The performance specifications are nominal and conform to acceptable industry standards. For applications at conditions beyond these specifications, consult the local Johnson Controls office. Johnson Controls shall not be liable for damages resulting from misapplication or misuse of its products. © 2019 Johnson Controls www.johnsoncontrols.com

Rotary Actuator Accessories (Continued)

M9104-AGx-2Nxx and M9106-AGx-2Nxx Series Actuator Accessories







M9106-AGA-2N



M9106-AGS-2N

M9104-AGx-2Nxx and M9106-AGx-2Nxx Series Actuator Accessories

	Code Number	Description	Qty
Variable Air Volume (VAV) System Accessories			
 <small>(CBL-2000-1.tif)</small>	CBL-2000-1	20 in. (0.5 m) plenum rated wiring harness	1
 <small>(CBL-2000-2.tif)</small>	CBL-2000-2	20 in. (0.5 m) plenum rated wiring harness	1
 <small>(CBL-2000-3.tif)</small>	CBL-2000-3	72 in. (1.8 m) plenum rated wiring harness	1
 <small>(DPT-2015-0.tif)</small>	DPT-2015-0	0 to 1.5 in W.C. (0 to 375 Pa) differential pressure transmitter	1

Rotary Actuator Accessories (Continued)

M9102-xGA-xS and M(VA)9104-xGA-xS Series Actuator Accessories



M9102/9104-xGA-2S
(M9102-AGA-2S.tif)



M9102/9104-xGA-3S
(M9102-IGA-3S.tif)

M9102-xGA-xS and M(VA)9104-xGA-xS Series Actuator Accessories

	Code Number	Description	Qty
Valve Linkages			
<p>(M9000-550 #01.cdr) from 34-636-1816</p>	M9000-551	VG1000 ball valve linkage (for use with M9104 Series actuators only)	1
<p>(M9000_561.jpg)</p>	M9000-561	Thermal barrier for M9000-560 and M9000-551 ball valve linkages. Permits use of M(VA)9xxx actuators on VG1000 Series ball valves with low-pressure steam	1
	M9000-700	Universal Ball Valve Linkage Kit	
Weather Shields			
<p>(M9000_341.jpg)</p>	M9000-342	Weather shield NEMA4x (IP66), 1/2 to 2 in. for VG1000 Series ball valves	1
Wiring Accessories			
<p>(M9104-100.tif)</p>	M9104-100	3/8 in. (10 mm) flexible metal conduit adapter kit (for use with M9102-xxx-2S or M9104-xxx-2S actuators with integrated wiring harness only)	10

The performance specifications are nominal and conform to acceptable industry standards. For applications at conditions beyond these specifications, consult the local Johnson Controls office. Johnson Controls shall not be liable for damages resulting from misapplication or misuse of its products. © 2019 Johnson Controls www.johnsoncontrols.com





Rotary Actuator Accessories (Continued)

M9106-xGx-2 and M9109-xGx-2 Series Actuator Accessories



M9106-GGA-2
(M9106-GGA-2.tif)

M9106-xGx-2 and M9109-xGx-2 Series Actuator Accessories

	Code Number	Description ¹	Qty
Mounting Brackets			
 <small>(M9000-160.tif)</small>	M9000-160	Anti-rotation bracket for M9106(9) and M9108(16)(24)(32) Series actuators	1
Damper Linkages / Accessories			
 <small>(DMPR-KC003.tif)</small>	DMPR-KC003	Blade pin extension (Ø 1/2 x 7 in.) (for use with D1300 dampers only)	1
Weather Shields			
 <small>(M9000-310.tif)</small>	M9000-310	NEMA 3R weather shield for control dampers	1
Wiring Accessories			
 <small>(M9000-105.tif)</small>	M9000-105	Pluggable 3-terminal block	1
 <small>(M9000-106.tif)</small>	M9000-106	Pluggable 4-terminal block	1

1. Ø means round shaft size (diameter); □ means square shaft size (each side)







Rotary Actuator Accessories (Continued)

M9108, M9116, M9124, and M9132 Series Actuator Accessories

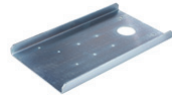
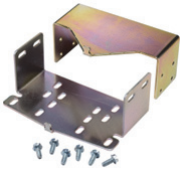

M9108-AGA-2
(M9108-AGA-2.tif)









M9108, M9116, M9124, and M9132 Series Actuator Accessories (Part 1 of 4)

	Code Number	Description ¹	Qty
Shaft Couplers / Position Indicators			
 <small>(from LIT-1900167)</small>	 <small>(M9000-154.tif)</small>	M9000-154 Jackshaft coupler kit for M9108 (16) (24) (32) Series actuators, (Ø 1 in.)	1
Mounting Brackets			
 <small>(M9000-152.tif)</small>	M9000-152	Reinforcing plate for mounting to thin sheet metal	1
 <small>(M9000-158.tif)</small>	M9000-158	Tandem mounting bracket	1
 <small>(M9000-160.tif)</small>	M9000-160	Anti-rotation bracket	1
Damper Linkages / Accessories			
 <small>(DMPR-KC003.tif)</small>	DMPR-KC003	Blade pin extension (Ø 1/2 x 7 in.) (for use with D1300 dampers only)	1
 <small>(DMPR-KC054.tif)</small>	DMPR-KC054	Blade pin extension (Ø 1/2 x 7 in.) (for use with D1300 dampers only)	1

The performance specifications are nominal and conform to acceptable industry standards. For applications at conditions beyond these specifications, consult the local Johnson Controls office. Johnson Controls shall not be liable for damages resulting from misapplication or misuse of its products. © 2019 Johnson Controls www.johnsoncontrols.com

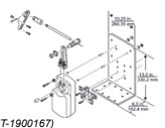



Rotary Actuator Accessories (Continued)

M9108, M9116, M9124, and M9132 Series Actuator Accessories (Part 2 of 4)

	Code Number	Description ¹	Qty
 <small>(DMPR-KC100.tif)</small>	DMPR-KC100	Damper blade linkage (for use with D1300 dampers only)	1
 <small>(DMPR-KC102.tif)</small>	DMPR-KC102	Damper push rod, Ø 5/16 x 48 in.	1
 <small>(DMPR-KC260.tif)</small>	DMPR-KC254	Damper mount linkage kit (for use with D1300 dampers only)	1
 <small>(DMPR-KC300)</small>	DMPR-KC300	Ball joint for Ø 5/16 in. rod, 1/4-20 x 9/16 in. thread mount	10
 <small>(M9000-150.tif)</small>	M9000-150	Damper mounting kit for remote, inside-duct mounting an M9108 (16) (24) Series actuator to a three-blade or larger damper	1
 <small>(from LIT-1900167)</small>  <small>(M9000-151.tif)</small>	M9000-151	Remote mounting kit, with crankarm and damper linkage for M9108 (16) (24) Series actuators Use the M9000-151 linkage only on three-blade or larger dampers (not for use with M9132 Series actuators or tandem applications)	1
 <small>(M9000-153.tif)</small>	M9000-153	Crankarm kit (not for use with M9132 Series actuators or tandem applications)	1
 <small>(M9000_400.jpg)</small>	M9000-400	Jackshaft mounting kit, Ø 0.5 to 1.05 in.	1
 <small>(M9000_402.jpg)</small>	M9000-402	Replacement hardware for M9000-400 jackshaft mounting kit	1

Rotary Actuator Accessories (Continued)





M9108, M9116, M9124, and M9132 Series Actuator Accessories (Part 3 of 4)

	Code Number	Description ¹	Qty
Valve Linkages			
 <small>(M9000-155.tif)</small>	M9000-155	Manual handle	1
 <small>(M9000-531.tif)</small>	M9000-530	VG2000 linkage kit for single M9116 (24) Series electric actuator and Johnson Controls® 2-1/2 in. cast iron globe valves with 3/8 in. stems	1
	M9000-531	VG2000 linkage kit for a single M9116 (24) Series electric actuator and Johnson Controls 3 to 4 in. cast iron globe valves with 3/8 in. stems	1
	M9000-533	VG2000 linkage kit for a single M9124 Series electric actuator and Johnson Controls 5 in. cast iron globe valves with 1/2 in. stems	1
	M9000-535	VG2000 linkage kit for a single M9124 Series electric actuator and Johnson Controls 6 in. cast iron globe valves with 1/2 in. stems	1
 <small>(M9000-534.tif)</small>	M9000-532	VG2000 linkage kit for tandem M9124 Series electric actuators and Johnson Controls 3 to 4 in. cast iron globe valves with 3/8 in. stems	1
	M9000-534	VG2000 linkage kit for tandem M9124 Series electric actuators and Johnson Controls 5 in. cast iron globe valves with 1/2 in. stems	1
	M9000-536	VG2000 linkage kit for tandem M9124 Series electric actuators and Johnson Controls 6 in. cast iron globe valves with 1/2 in. stems	1
	M9000-537	VG2000 linkage kit for tandem M9124 Series electric actuators and Johnson Controls 3 to 4 in. cast iron globe valves with 1/2 in. stems	1
 <small>(M9000-610.tif)</small>	M9000-610	Tandem actuator adapter kit for VG2000 Series iron globe valve linkages (not for use with the M9000-530 linkage)	1

The performance specifications are nominal and conform to acceptable industry standards. For applications at conditions beyond these specifications, consult the local Johnson Controls office. Johnson Controls shall not be liable for damages resulting from misapplication or misuse of its products. © 2019 Johnson Controls www.johnsoncontrols.com

Rotary Actuator Accessories (Continued)

M9108, M9116, M9124, and M9132 Series Actuator Accessories (Part 4 of 4)

	Code Number	Description ¹	Qty
Weather Shields			
 <small>(M9000-310.tif)</small>	M9000-310	NEMA 3R weather shield for control dampers or M9000-53x linkage kits on VG2000 Series cast iron flanged globe valves	1
 <small>(M9000-330.tif)</small>	M9000-330	NEMA 3R weather shield for VG1000 Series non-spring-return ball valves with M9000-518 linkage	1
Wiring Accessories			
 <small>(M9000-105.tif)</small>	M9000-105	Pluggable 3-terminal block	
Miscellaneous (Unique to M9108[16][24][32] Series Actuators)			
 <small>(M9000-103.tif)</small>	M9000-103	Transformer, Class 2, 120/24 VAC	1
 <small>(M9000-104.tif)</small>	M9000-104	Transformer, Class 2, 230/24 VAC	1

1. Ø means round shaft size (diameter); □ means square shaft size (each side)

Rotary Actuator Accessories (Continued)

M(VA)9308 M(VA)9310 Series Actuator Accessories







M9310









VA9310

Accessories (Order Separately) (Part 1 of 3)

	Code Number	Description	Qty
Damper Linkages / Accessories			
	DMPR-KC003	Blade pin extension (Ø 1/2 x 7 in.) (for use with D1300 dampers only)	1
 <small>(M9000_400.jpg)</small>	M9000-400	Jackshaft mounting kit, Ø 0.5 to 1.05 in.	1
Weather Shields			
 <small>(M9000_321.jpg)</small>	M9000-322	Weather shield NEMA 4x (IP66), for M9300 on dampers	1
	M9000-342	Weather shield NEMA4x (IP66), 1/2 to 2 in. for VA9300 on VG1000 Series ball valves	1

Rotary Actuator Accessories (Continued)

Accessories (Order Separately) (Part 2 of 3)

	Code Number	Description	Qty
Valve Linkages			
 <p>(M9000_561.jpg)</p>	M9000-561	Thermal barrier	1
 <p>(M9000_561.jpg)</p>	M9000-700	Universal Ball Valve Linkage Kit	1
Mounting Brackets			
 <p>(M9000_604.jpg)</p>	M9000-604	Anti-rotation bracket	1
Shaft Couplers / Position Indicators			
	M9000-606	Position indicators, M9203, M9208, and M9300 Series	1
	M9300-2	Auxiliary Contact Kit	1
	M9300-100	Threaded Conduit Adapters for 1/2 in. electrician's fittings	5

Rotary Actuator Accessories (Continued)

Accessories (Order Separately) (Part 3 of 3)

	Code Number	Description	Qty
	M9300-140	Feedback Potentiometer 140k ohms	1
	M9000-151	Remote mounting kit, with crank arm and damper linkage for M9108 (16) (24) Series Actuators	1
	M9300-1K	Feedback Potentiometer 1k ohms	1
	M9300-2K	Feedback Potentiometer 2k ohms	1
	M9300-10K	Feedback Potentiometer 10k ohms	1
	M9310-500	Replacement VA9308/9310 valve linkage kit	1
	M9310-600	Replacement M9308/9310 gripper assembly	1

Rotary Actuator Accessories (Continued)

M(VA)9316, M(VA)9320 and M(VA)9335 Series Actuator Accessories







M9335



VA9320

Accessories (Order Separately) (Part 1 of 3)

	Code Number	Description	Qty
Damper Linkages / Accessories			
	DMPR-KC003	Blade pin extension (Ø 1/2 x 7 in.) (for use with D1300 dampers only)	1
 <small>(M9000_400.jpg)</small>	M9000-400	Jackshaft mounting kit, Ø 0.5 to 1.05 in.	1
Weather Shields			
 <small>(M9000_321.jpg)</small>	M9000-323	Weather shield NEMA 4x (IP66), for M9300 on dampers	1
	M9000-343	Weather shield NEMA4x (IP66), 1/2 to 2 in. for M9300 on VG1000 Series ball valves	1
Valve Linkages			

Rotary Actuator Accessories (Continued)

Accessories (Order Separately) (Part 2 of 3)

	Code Number	Description	Qty
 <small>(M9000_561.jpg)</small>	M9000-539	Adapter for M9000-53x linkages	1
Mounting Brackets			
 <small>(M9000_604.jpg)</small>	M9000-604	Anti-rotation bracket	1
	M9300-100D	Butterfly Valve Mounting Kit for Tandem M9300 Series Non-Spring Return Electric Actuators to 4, 5 and 6 in. (DN 100, 125 & 150)	1
	M9300-100S	Butterfly Valve Mounting Kit for a Single M9300 Series Non-Spring Return Electric Actuator to 2, 3 and 4 in. (DN 50, 80 & 100)	1
	M9300-200S	Butterfly Valve Mounting Kit for a Single M9300 Series Non-Spring Return Electric Actuator to 8 in. (DN 200)	1
Shaft Couplers / Position Indicators			
	M9000-606	Position indicators, M9203, M9208, and M9300 Series	1
	M9300-2	Auxiliary Contact Kit	1

Rotary Actuator Accessories (Continued)

Accessories (Order Separately) (Part 3 of 3)

	Code Number	Description	Qty
	M9300-100	Threaded Conduit Adapters for 1/2 in. electrician's fittings	5
	M9300-140	Feedback Potentiometer 140k ohms	1
	M9000-151	Remote mounting kit, with crank arm and damper linkage for M9108 (16) (24) Series Actuators	1
	M9300-1K	Feedback Potentiometer 1k ohms	1
	M9300-2K	Feedback Potentiometer 2k ohms	1
	M9300-10K	Feedback Potentiometer 10k ohms	1
	M9320-500	Replacement VA9320/9335 valve linkage kit	1
	M9320-600	Replacement M9320/9335 gripper assembly	1





Rotary Actuator Accessories (Continued)

M(VA)9203 Series Actuator Accessories



M9203-GGB-2
(M9203.jpg)







M(VA)9203 Series Actuator Accessories (Part 1 of 4)

	Code Number	Description ¹	Qty
Shaft Couplers / Position Indicators			
 <small>(M9000_606.jpg)</small>	M9000-606	Position indicators, M9203 and M9208 Series	5
 <small>(M9203_601.jpg)</small>	M9203-601	Standard coupler kit, M9203 Series (Ø 1/4 to 1/2 in.) (□ 1.4 to 5/16 in.)	1
 <small>(M9203_602.jpg)</small>	M9203-602	Retainer for M9203 coupler	5
Mounting Brackets			
 <small>(M9000_604.jpg)</small>	M9000-604	Anti-rotation bracket	1

The performance specifications are nominal and conform to acceptable industry standards. For applications at conditions beyond these specifications, consult the local Johnson Controls office. Johnson Controls shall not be liable for damages resulting from misapplication or misuse of its products. © 2019 Johnson Controls www.johnsoncontrols.com

Rotary Actuator Accessories (Continued)

M(VA)9203 Series Actuator Accessories (Part 2 of 4)

	Code Number	Description ¹	Qty
Weather Shields			
 <small>(M9000_321.jpg)</small>	M9000-322	Weather shield NEMA 4x (IP66), control dampers	1
 <small>(M9000_341.jpg)</small>	M9000-342	Weather shield NEMA 4x (IP66), 1/2 to 2 in. VG1000 Series ball valves	1
Damper Linkages / Accessories			
 <small>(DMPR-KC003.tif)</small>	DMPR-KC003	Blade pin extension (Ø 1/2 x 7 in.) (for use with D1300 dampers only)	1
 <small>(DMPR-KC054.tif)</small>	DMPR-KC054	Damper blade arm (for use with D1300 dampers only)	1
 <small>(DMPR-KC100.tif)</small>	DMPR-KC100	Damper blade linkage (for use with D1300 dampers only)	1
 <small>(DMPR-KC102.tif)</small>	DMPR-KC102	Blade pin extension (Ø 1/2 x 7 in.) (for use with D1300 dampers only)	1
 <small>(M9203_100.jpg)</small>	M9203-100	Remote mounting kit with crankarm	1





Rotary Actuator Accessories (Continued)

M(VA)9203 Series Actuator Accessories (Part 3 of 4)

	Code Number	Description ¹	Qty
 <p>(M9203_110.jpg)</p>	M9203-110	Universal mounting kit	1
 <p>(M9203_115.jpg)</p>	M9203-115	Universal mounting kit with crankarm	1
 <p>(M9203_150.jpg)</p>	M9203-150	Crankarm kit	1
 <p>(M9203_250.jpg)</p>	M9203-250	Remote mounting kit with crankarm and damper linkage for D1300 dampers	1
 <p>(M9000_605.jpg)</p>	M9000-605	Ball joint for Ø 1/4 and Ø 5/16 in. rods, 5/16-24 x 33/64 in. thread mount	5
Adjustable Stops			
 <p>(M9203_603.jpg)</p>	M9203-603	Adjustable stop kit	1

Rotary Actuator Accessories (Continued)

M(VA)9203 Series Actuator Accessories (Part 4 of 4)

	Code Number	Description ¹	Qty
Valve Linkages			
 <p><small>(M9000_607.jpg)</small></p>	M9000-607	Position indicators, VA9203 and VA9208 Series	5
 <p><small>(M9000_560.jpg)</small></p>	M9000-560	Ball valve linkage for spring return, 1/2 to 2 in. hot and chilled water applications	1
 <p><small>(M9000_561.jpg)</small></p>	M9000-561	Thermal barrier	1
 <p><small>(M9000_700.jpg)</small></p>	M9000-700	Universal Ball Valve Linkage Kit	1

1. Ø means round shaft size (diameter); □ means square shaft size (each side)







Rotary Actuator Accessories (Continued)

M(VA)9208 Series Actuator Accessories



M9208-BAC-3
(M9208-BAC-3.tif)









M(VA)9208 Series Actuator Accessories (Part 1 of 3)

	Code Number	Description ¹	Qty
Shaft Couplers / Position Indicators			
 (M9000-600.tif)	M9208-600	Large coupler kit for use with M9208 Series actuators (Ø 1/2 to 3/4 in. and □ 3/8 to 9/16 in.)	1
 (M9000-601.tif)	M9208-601	Standard coupler kit for use with M9208 Series actuators (Ø 5/16 to 5/8 in. and □ 1/4 to 1/2 in.)	1
 (M9208-602.tif)	M9208-602	Retainer for M9208 coupler	5
Mounting Brackets			
 (M9000-604.tif)	M9000-604	Anti-rotation bracket	1
Tools			
 (M9220-604.tif)	M9220-604	Long manual crank, 2-13/16 in. (72 mm) crank radius	5
 (M9208-605.tif)	M9208-605	Short manual crank, 1-13/16 in. (47 mm) crank radius	5
 (M9000_321.jpg)	M9000-322	Weather shield NEMA 4X(IP66), control dampers	1

The performance specifications are nominal and conform to acceptable industry standards. For applications at conditions beyond these specifications, consult the local Johnson Controls office. Johnson Controls shall not be liable for damages resulting from misapplication or misuse of its products. © 2019 Johnson Controls www.johnsoncontrols.com

Rotary Actuator Accessories (Continued)









M(VA)9208 Series Actuator Accessories (Part 2 of 3)

	Code Number	Description ¹	Qty
Weather Shields			
 <small>(M9000_341.jpg)</small>	M9000-342	Weather shield NEMA 4X(IP66), 1/2 to 2 in. VG1000 Series ball valves	1
Damper Linkages / Accessories			
 <small>(DMPR-KC003.tif)</small>	DMPR-KC003	Blade pin extension (Ø 1/2 x 7 in.) (for use with D1300 dampers only)	1
 <small>(DMPR-KC054.tif)</small>	DMPR-KC054	Damper blade arm (for use with D1300 dampers only)	1
 <small>(DMPR-KC100.tif)</small>	DMPR-KC100	Damper blade linkage (for use with D1300 dampers only)	1
 <small>(DMPR-KC102.tif)</small>	DMPR-KC102	Damper push rod, Ø 5/16 x 48 in.	1
 <small>(M9000_400.jpg)</small>	M9000-400	Jackshaft mounting kit, Ø 0.5 to 1.05 in.	
 <small>(M9000_402.jpg)</small>	M9000-402	Replacement hardware for M9000-400 jackshaft mounting kit	
 <small>(M9000_605.jpg)</small>	M9000-605	Ball joint for Ø 1/4 and Ø 5/16 in. rods, 5/16-24 x 33/64 in. thread mount	5
 <small>(M9208-100.tif)</small>	M9208-100	Remote mounting kit with crankarm	1

The performance specifications are nominal and conform to acceptable industry standards. For applications at conditions beyond these specifications, consult the local Johnson Controls office. Johnson Controls shall not be liable for damages resulting from misapplication or misuse of its products. © 2019 Johnson Controls www.johnsoncontrols.com

Rotary Actuator Accessories (Continued)

M(VA)9208 Series Actuator Accessories (Part 3 of 3)

	Code Number	Description ¹	Qty
Damper Linkages / Accessories			
 <small>(M9208-150.tif)</small>	M9208-150	Crankarm kit	1
 <small>(M9208-250.tif)</small>	M9208-250	Remote mounting kit with crankarm and damper linkage (for use with D1300 dampers only)	1
Adjustable Stops			
 <small>(M9208-603.tif)</small>	M9208-603	Adjustable stop kit	1
Wiring Accessories			
 <small>(M9200_100.jpg)</small>	M9200-100	Threaded conduit adapters for 1/2 in. electrician's fittings	1
Valve Linkages			
 <small>(M9000_607.jpg)</small>	M9000-607	Position indicators, VA9203 and VA9208 Series	5
 <small>(M9000_560.jpg)</small>	M9000-560	Ball valve linkage for spring return, 1/2 to 2 in. hot and chilled water applications	1
 <small>(M9000_561.jpg)</small>	M9000-561	Thermal barrier	1
 <small>(M9000_561.jpg)</small>	M9000-700	Universal Ball Valve Linkage Kit ²	1

1. Ø means round shaft size (diameter); □ means square shaft size (each side)

2. For VA9208 Series Actuators: Use field furnished #10-24 x 3 1/2" screws and two locking nuts #10-24.







Rotary Actuator Accessories (Continued)

M9220 Series Actuator Accessories



M9220-BAC-3
(M9220-BAC-3.tif)



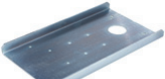
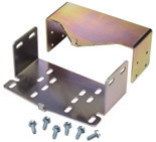







M9220 Series Actuator Accessories (Part 1 of 4)

	Code Number	Description ¹	Qty
Shaft Couplers / Position Indicators			
 (M9000-611.tif)	M9000-611	Position indicators for use with M9220 Series actuators	5
 (M9220-600A.tif)	M9220-600	Jackshaft coupler kit for use with M9220 Series actuators Ø 3/4 in. to 1-1/16 in. (19 to 27 mm) round shafts; or 5/8 and 3/4 in. (16, 18 and 19 mm) square shafts	1
 (M9220-601.tif)	M9220-601	Standard coupler kit for use with M9220 Series actuators Ø 1/2 to 3/4 in. (12 to 19 mm) round shafts; or 3/8 and 1/2 in. (10, 12 and 14 mm) square shafts	1
 (M9220-602.tif)	M9220-602	Retainer for M9220 coupler	5
 (M9220-610.tif)  (M9220-602.tif)	M9220-610	10 mm square shaft adapter with retainer	1
	M9220-612	12 mm square shaft adapter with retainer	1
	M9220-614	14 mm square shaft adapter with retainer	1
Mounting Brackets			
 (M9000-152.tif)	M9000-152	Reinforcing plate for mounting to thin sheet metal	1
 (M9000-158.tif)	M9000-158	Tandem mounting bracket	1

The performance specifications are nominal and conform to acceptable industry standards. For applications at conditions beyond these specifications, consult the local Johnson Controls office. Johnson Controls shall not be liable for damages resulting from misapplication or misuse of its products. © 2019 Johnson Controls www.johnsoncontrols.com

Rotary Actuator Accessories (Continued)







M9220 Series Actuator Accessories (Part 2 of 4)

	Code Number	Description ¹	Qty
 <small>(M9000-604.tif)</small>	M9000-604	Anti -rotation bracket	1
Damper Linkages / Accessories			
 <small>(DMPR-KC003.tif)</small>	DMPR-KC003	Blade pin extension (Ø 1/2 x 7 in.) (for use with D1300 dampers only)	1
 <small>(DMPR-KC054.tif)</small>	DMPR-KC054	Damper blade arm (for use with D1300 dampers only)	1
 <small>(DMPR-KC100.tif)</small>	DMPR-KC100	Damper blade linkage (for use with D1300 dampers only)	1
 <small>(DMPR-KC102.tif)</small>	DMPR-KC102	Damper push rod, Ø 5/16 x 48 in.	1
 <small>(DMPR-KC260.tif)</small>	DMPR-KC260	Damper mount linkage kit (for use with D1300 dampers only)	1
 <small>(M9000-153.tif)</small>	M9000-153	Crankarm kit (not for use with M9132 series actuators or tandem applications)	1
 <small>(M9000-170.tif)</small>	M9000-170	Remote mounting kit (horizontal) with crankarm and ball joint	1
 <small>(M9000-171.tif)</small>	M9000-171	Remote mounting kit (vertical) with crankarm and ball joint	1
 <small>(M-9000-270.tif)</small>	M9000-270	Remote mounting kit (horizontal) with crankarm and damper linkage (for use with D1300 dampers only)	1

The performance specifications are nominal and conform to acceptable industry standards. For applications at conditions beyond these specifications, consult the local Johnson Controls office. Johnson Controls shall not be liable for damages resulting from misapplication or misuse of its products. © 2019 Johnson Controls www.johnsoncontrols.com

Rotary Actuator Accessories (Continued)







M9220 Series Actuator Accessories (Part 3 of 4)

	Code Number	Description ¹	Qty
 <small>(M9000-271.tif)</small>	M9000-271	Remote mounting kit (vertical) with crankarm and damper linkage (for use with D1300 dampers only)	1
 <small>(M9000_400.jpg)</small>	M9000-400	Jackshaft mounting kit, Ø 0.5 to 1.05 in.	1
 <small>(M9000_402.jpg)</small>	M9000-402	Replacement hardware for M9000-400 jackshaft mounting kit	1
 <small>(M9000_605.jpg)</small>	M9000-605	Ball joint for Ø 1/4 and Ø 5/16 in. rods, 5/16-24 x 33/64 in. thread mount	5
 <small>(M9220-605.tif)</small>	M9220-605	Ball joint for M8x1.25 threaded rod, M8x1.25 x 16.5 mm thread mount	5
Valve Linkages			
 <small>(M9000-518.tif)</small>	M9000-519	Ball valve linkage for spring return, 2-1/2 to 6 in. VG1000 flanged valves with 11 mm square stem	1
 <small>(M9000-531.tif)</small>	M9000-530	VG2000 linkage kit for M9220 Series electric actuator and Johnson Controls 2-1/2 in. cast iron globe valves with 3/8 in. stems	1
	M9000-531	VG2000 linkage kit for a single M9220 Series electric actuator and Johnson Controls 3 in. and 4 in. cast iron globe valves with 3/8 in. stems	1
	M9000-533	VG2000 linkage kit for a single M9220 Series electric actuator and Johnson Controls 5 in. cast iron globe valves with 1/2 in. stems	1
	M9000-535	VG2000 linkage kit for a single M9220 Series electric actuator and Johnson Controls 6 in. cast iron globe valves with 1/2 in. stems	1

The performance specifications are nominal and conform to acceptable industry standards. For applications at conditions beyond these specifications, consult the local Johnson Controls office. Johnson Controls shall not be liable for damages resulting from misapplication or misuse of its products. © 2019 Johnson Controls www.johnsoncontrols.com

Rotary Actuator Accessories (Continued)

M9220 Series Actuator Accessories (Part 4 of 4)

	Code Number	Description ¹	Qty
 <small>(M9000-535.tif)</small>	M9000-532	VG2000 linkage kit for tandem M9220 Series electric actuators and Johnson Controls 3 in. and 4 in. cast iron globe valves with 3/8 in. stems	1
	M9000-534	VG2000 linkage kit for tandem M9220 Series electric actuators and Johnson Controls 5 in. cast iron globe valves with 1/2 in. stems	1
	M9000-536	VG2000 linkage kit for tandem M9220 Series electric actuators and Johnson Controls 6 in. cast iron globe valves with 1/2 in. stems	1
	M9000-537	VG2000 linkage kit for tandem M9220 Series electric actuators and Johnson Controls 3 in. and 4 in. cast iron globe valves with 1/2 in. stems	1
 <small>(M9000-610.tif)</small>	M9000-610	Tandem actuator adapter kit for VG2000 Series iron globe valve linkages (not for use with the M9000-530 linkage)	1
Weather Shields			
 <small>(M9000-320.tif)</small>	M9000-320	NEMA 3R weather shield for control dampers or M9000-53x Series linkage kits on VG2000 Series cast iron flanged globe valves	1
 <small>(M9000-340.tif)</small>	M9000-340	NEMA 5 weather shield for VG1000 Series ball valves with M9000-517 or M9000-519 linkage, spring return	1
Adjustable Stops			
 <small>(M9220-603.tif)</small>	M9220-603	Adjustable stop kit	1
Wiring Accessories			
 <small>(M9200_100.jpg)</small>	M9200-100	Threaded conduit adapters for 1/2 in. electrician's fittings	
Tools			
 <small>(M9220-604.tif)</small>	M9220-604	Manual crank	5

1. Ø means round shaft size (diameter); □ means square shaft size (each side)

Rotary Actuator Accessories (Continued)

Miscellaneous Accessories

Miscellaneous Accessories

	Code Number	Description	Qty
Transformers			
 <small>(Y63T22.tif)</small>	Y63T22-0	Transformer, 50 VA Class 2, 120/208/240 to 24 VAC 60 Hz, box mounting	1
 <small>(Y63T31.tif)</small>	Y63T31-0	Transformer, 50 VA Class 2, 120/208/240 to 24 VAC 60 Hz, foot/box mounting	1
 <small>(Y64T15.tif)</small>	Y64T15-0	Transformer, 92 VA Class 2, 120/208/240 to 24 VAC 60 Hz, foot mounting	1
 <small>(Y64T21.tif)</small>	Y64T21-0	Transformer, 92 VA Class 2, 120/208/240 to 24 VAC 60 Hz, box mounting	1
 <small>(Y64T22.tif)</small>	Y64T22-0	Transformer, 92 VA Class 2, 120/208/240 to 24 VAC 60 Hz, box mounting	1
 <small>(Y65A13.tif)</small>	Y65A13-0	Transformer, 40 VA Class 2, 120 to 24 VAC 60 Hz, foot mounting	1
 <small>(Y65A21.tif)</small>	Y65A21-0	Transformer, 40 VA Class 2, 120 to 24 VAC 60 Hz, box mounting	1
 <small>(Y65G13.tif)</small>	Y65G13-0	Transformer, 40 VA Class 2, 24 to 24 VAC 60 Hz isolation, foot mounting	1
 <small>(Y65S13.tif)</small>	Y65S13-0	Transformer, 40 VA Class 2, 208/240 to 24 VAC 60 Hz, foot mounting	1
 <small>(Y66T12.tif)</small>	Y66T12-0	Transformer, 75 VA Class 2, 120/208/240 to 24 VAC 60 Hz, foot mounting	1
 <small>(Y66T13.tif)</small>	Y66T13-0	Transformer, 75 VA Class 2, 120/208/240 to 24 VAC 60 Hz, foot mounting	1

D-3031 Pneumatic Piston Damper Actuator

Description

The D-3031 Pneumatic Piston Damper Actuator is designed primarily for damper positioning on small terminal units. Models are furnished with 1 in. (25 mm) stroke, and have two movable adjustment stops to facilitate adjusting the stroke in 1/8 in. increments.

The D-3031 features a polycarbonate top and body and a threaded 5/16 in. (8 mm) diameter piston rod for convenient linkage attachment.

The D-3031 is the unit replacement for the D-160 and D-251 #2S actuators.

Refer to the *D-3031 Pneumatic Actuator Product Bulletin (LIT-2681050P)* for important product application information.

Applications

The D-3031 is designed to operate normally open or normally closed dampers using either swivel or rigid type face mounting. The actuator can be rotated to locate the air connection in the preferred position.

Refer to *D-3031 Pneumatic Actuator (Part No. 34-175-2)* for mounting and bracket details and arrangements.

The D-3031 has a maximum stroke of 1 in. without stops. Two stroke adjustment stops are provided for limiting the stroke in 1/8 in. increments from 7/8 in. to 1/2 in.

Features

- high power-to-size ratio for locations in confined spaces
- swivel or rigid mounting options for flexible mounting configurations
- optional mounting kits to cover any application and replacement of obsolete units
- barbed fitting for 5/32 in. or 1/4 in. Outside Diameter (O.D.) tubing

Repair Information

If the D-3031 Pneumatic Actuator fails to operate within its specifications, replace the unit. For a replacement actuator, contact the nearest Johnson Controls® representative.



D-3031 Pneumatic Piston Damper Actuator

WARNING: Risk of Personal Injury and Property Damage.

Do not install the D-3031 Pneumatic Piston Damper Actuator in any application using corrosive solvents or refrigerants. Use of the D-3031 Pneumatic Piston Damper Actuator with corrosive solvents or refrigerants may weaken the structure of the actuator resulting in a release of pressure which could cause property damage, severe personal injury, or death.

IMPORTANT: Clean with mild soap and water only. If other solvents are to be used, consult with factory for compatibility with polycarbonate.

IMPORTANT: The following solvents will harm polycarbonate: Acetone, all chlorinated solvents (Perchloroethylene, Trichloroethylene, Chloroethene NU T-9999-3, and others), Benzene, Carbon tetrachloride, Ethylacrylate (Leak Detector #7-P), Ethylene Dichloride, Freon (refrigerant and spray can propellant), Hydrochloric Acid (concentrated), Methyl Alcohol, Methylene Chloride, Nitro Cellulose Lacquer, Toluene, some synthetic compressor oils, and Xylene.

Selection Chart

Code Number	Nominal Spring Range, psig (kPa)
D-3031-3	5 to 10 (35 to 70)
D-3031-4	8 to 13 (56 to 91)

Accessories

Code Number	Description	Weight, lb (kg)
D-3031-100	Mounting Bracket Kit	3.5 (1.59)
D-3031-101	Type W Mounting Plate	0.8 (0.36)
D-3031-102	Type W Linkage Kit with 5/16 in. Crankarm for 45° Movement	0.8 (0.36)
DMPR-KC005	Shaft Extension Kit	1.0 (0.45)

Maximum Actuator Force¹

Supply Pressure, psig (kPa)	Nominal Spring Range, psig (kPa)	Stroke	Force, lb (Newton)	Torque Output for 90° Rotation
15 (105)	5 to 10 (35 to 70)	Power	14 (62.3)	19.5 lb·in (2.2 N·m)
		Return	14 (62.3)	19.5 lb·in (2.2 N·m)
	8 to 13 (56 to 91)	Power	5.6 (24.9)	7.8 lb·in (0.9 N·m)
		Return	22.4 (99.6)	31.4 lb·in (3.6 N·m)
20 (140)	5 to 10 (35 to 70)	Power	28 (124.6)	39.2 lb·in (4.4 N·m)
		Return	14 (62.3)	19.5 lb·in (2.2 N·m)
	8 to 13 (56 to 91)	Power	19.6 (87.2)	27.3 lb·in (3.1 N·m)
		Return	22.4 (99.6)	31.4 lb·in (3.6 N·m)

1. Force calculated using 1.4 lb/psig available actuator force.

Technical Specifications

D-3031 Pneumatic Piston Damper Actuator		
Stroke	1 in. (25 mm); Adjustable with Stops to 7/8, 3/4, 5/8, and 1/2 in. (22, 19, 16, and 13 mm)	
Effective Diaphragm Area	2.8 in. ² (18 cm ²)	
Spring Ranges	D-3031-3	5 psig to 10 psig (35 kPa to 70 kPa)
	D-3031-4	8 psig to 13 psig (56 kPa to 91 kPa)
Piston Rod	Threaded, 5/16 in. Diameter	
Ambient Temperature Limits	-20°F to 150°F (-29°C to 66°C)	
Control Pressure	15 psig or 20 psig (105 kPa or 140 kPa); 25 psig (175 kPa) Maximum	
Air Connection	Barbed Fitting for 5/32 in. or 1/4 in. O.D. Poly tubing	
Materials	Actuator and Nut	Polycarbonate
	Stops	Nylon
	Swivel Washers	Oilon
	Diaphragm	Synthetic Elastomer
	Rod and Spring	Steel
Mounting	Rigid or Swivel Type	
Accessories	D-3031-100	Bracket Accessory Kit
	D-3031-101	Mounting Plate Kit
	D-3031-102	Linkage Kit
	DMPR-KC005	Shaft Extension Kit
Shipping Weight	0.5 lb (0.23 kg)	

The performance specifications are nominal and conform to acceptable industry standards. For applications at conditions beyond these specifications, consult the local Johnson Controls office. Johnson Controls shall not be liable for damages resulting from misapplication or misuse of its products. © 2019 Johnson Controls. www.johnsoncontrols.com

D-3062 Pneumatic Piston Damper Actuator

Description

The D-3062 Pneumatic Actuator is a multipurpose positioning device used to accurately position small dampers primarily on VAV, terminal units, and small ventilating dampers in response to output signals of a pneumatic controller or electro-pneumatic transducer.

The actuator is also recommended for use on other airflow control dampers, in interior locations, with a maximum area of 4 square feet for proportional volume control and 6.25 square feet for two-position actuation provided that the torque requirements are compatible with the specific application.

Refer to the *D-3062 Pneumatic Actuator Product Bulletin (LIT-2681051P)* for important product application information.

Features

- high power-to-size ratio for locations in confined spaces
- all-aluminum housing which is lightweight and non-combustible
- telescoping linkage for fast and flexible installation
- front or rear mounting options for flexible mounting configurations
- optional mounting kits to cover any application and replacement of obsolete units

Applications

When used with proportional control, the damper size is limited to 4 square feet maximum.

Selection Charts

D3062 Pneumatic Piston Damper Actuators

Code Number	Nominal Spring Range, psig (kPa)
D-3062-1	3 to 7 (21 to 49)
D-3062-2	5 to 10 (35 to 70)
D-3062-3	8 to 13 (56 to 91)
D-3062-4	11 to 15 (77 to 105)
D-3062-41	8 to 13 (56 to 91) with universal mounting kit

Mounting Kits¹ for D-3062 Damper Actuators

Code Number	Description	Weight, lb (kg)
D-3062-100	Universal mounting kit for Type W (N.O. or N.C.) and Type F (N.C. only). The D-3062-100 mounting kit contains all parts required for the actuator to be mounted inside or outside the duct for use with D-1300 Series dampers.	3.5 (1.59)
D-3062-101	Auxiliary mounting kit for multi-position swivel mounting	0.8 (0.36)

1. Mounting kits include bracket, linkage, and all necessary mounting hardware.

As a two-position control, damper size is limited to 6.25 square feet. As determined by testing using Johnson Controls® D-1300 dampers, width and height are limited to 30 in. maximum.

Four nominal spring ranges are available: 3 psi to 7 psi (D-3062-1), 5 psi to 10 psi (D-3062-2), 8 psi to 13 psi (D-3062-3), and 11 psi to 15 psi (D-3062-4).

The control air pressure for normal HVAC operation is 0 to 20 psig. The minimum control pressure for safety damper ventilation mode is 20 psi with the maximum pressure of 30 psi. When used for both proportional and smoke applications, a separate air signal should be provided to override normal HVAC operations and enact safety damper functions.

Note: The D-3062 is not able to be configured for frame mounting in power fail open damper applications.

Repair Information

If the D-3062 Pneumatic Actuator fails to operate within its specifications, replace the unit. For a replacement actuator, contact the nearest Johnson Controls representative.

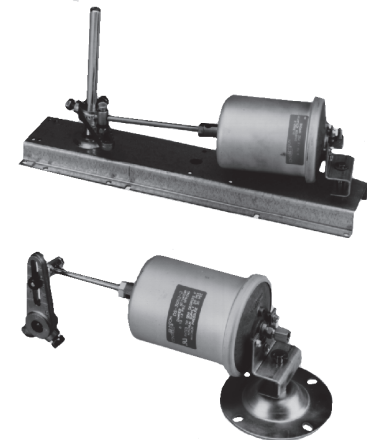

D-3062 Pneumatic Piston Damper Actuators

Accessories

Code Number	Description	Weight, lb (kg)
DMPR-KC050	Crankarm: 7/16 in. adjustable to 2-3/4 in. radius	0.5 (0.23)
DMPR-KC051	Crankarm: 3/8 in. adjustable to 2-3/4 in. radius	0.5 (0.23)
DMPR-KC053	Crankarm: 1/2 in. adjustable to 2-3/4 in. radius	0.5 (0.23)
DMPR-KC300	Swivel Ball Joint	0.5 (0.23)
D-9999-152	Clevis pin No. 6	0.5 (0.23)
D-9999-153	Twist lock, Pin No. A	0.5 (0.23)
D-3062-104	Clevis - fork type	0.5 (0.23)
D-3062-106	Rod - 1/4-20 threaded one end	0.5 (0.23)
D-3062-108	Rod - spade end	0.5 (0.23)
D-3073-604	Ball joint - weather resistant	0.5 (0.23)

D-3062 Pneumatic Piston Damper Actuator (Continued)

Technical Specifications

D-3062 Pneumatic Piston Damper Actuator	
Stroke	2 in. (51 mm)
Control Air Pressure	0 psig to 20 psig for HVAC 20 psig (137 kPa) minimum for safety damper functions 30 psig (205 kPa) maximum
Air Connections	1/8 in. NPT straight barbed fitting for 5/32 in. or 1/4 in. O.D. polytubing (furnished) Compression fitting for 1/4 in. O.D. copper tubing (F-200-3, order separately)
Ambient Operating Conditions (HVAC)	-20°F to 150°F (-29°C to 66°C)
Effective Diaphragm Area	6.6 in. ² (43 cm ²)
Materials	Body - aluminum; diaphragm - synthetic elastomer
Dimensions	3-3/16 in. diameter x 6-13/16 in. long
Shipping Weight, lb (kg)	1.2 (0.54)

Maximum Actuator Force at 20 psig (140 kPa)

Nominal Spring Range, psig (kPa)	Stroke	Force, lb (Newton)	Torque Output for 90° Rotation	D-3062-Suffix
3 to 7 (21 to 49)	Power	85.8 (382)	85.8 lb·in (9.69 N·m)	-1
	Return	19.8 (88)	19.8 lb·in (2.24 N·m)	
5 to 10 (35 to 70)	Power	66 (294)	66 lb·in (7.45 N·m)	-2
	Return	33 (147)	33 lb·in (3.73 N·m)	
8 to 13 (56 to 91)	Power	46.2 (206)	46.2 lb·in (5.22 N·m)	-3 -41
	Return	52.8 (235)	52.8 lb·in (5.96 N·m)	
11 to 15 (77 to 105)	Power	33 (147)	33 lb·in (3.73 N·m)	-4
	Return	72.6 (323)	72.6 lb·in (8.20 N·m)	

Note: Force calculated using 6.6 lb/psig available actuator force

D-3153, D-3244, D-3246 Pneumatic Actuators for VF Series Butterfly Valves

Description

The D-3153, D-3244, and D-3246 Pneumatic Actuators position the VF Butterfly Valve's disc in response to a pneumatic signal from a controller.

Refer to the *VF Series M9000 Electrically and D-3000 Pneumatically Actuated Standard-Pressure, Standard-Temperature Butterfly Valves Product Bulletin (LIT-977202)* for important product application information.

Features

Easily field mounted to VF Series Two-Way Butterfly Valves.

Applications

Used with VF Series Electric Butterfly Valves, 2 through 20 in., Two-Way and Three-Way.

Repair Information

If the D-3153, D-3244, or D-3246 Pneumatic Actuator fails to operate within its specifications, replace the unit. For a replacement actuator, contact the nearest Johnson Controls® representative.

Selection Chart

Code Number	Description	VF Series Butterfly Valve Size
D-3153-5120	Pneumatic Actuator with D-9502 Positioner For Use with VF Series Butterfly Valves	2, 2.5, 3 in. High Pressure, 4 in. Low Pressure
D-3153-5130	Pneumatic Actuator For Use with VF Series Butterfly Valves	2, 2.5, 3 in. High Pressure, 4 in. Low Pressure
D-3244-5100	Pneumatic Actuator with D-9502 Positioner For Use with VF Series Butterfly Valves	4 in. High Pressure, 5 in. Low Pressure
D-3244-5110	Pneumatic Actuator For Use with VF Series Butterfly Valves	4 in. High Pressure, 5 in. Low Pressure
D-3246-5100	Pneumatic Actuator with D-9502 Positioner For Use with VF Series Butterfly Valves	5 in. High Pressure, 6 in. High or Low Pressure, 8 or 10 in. Low Pressure
D-3246-5110	Pneumatic Actuator For Use with VF Series Butterfly Valves	5 in. High Pressure, 6 in. High or Low Pressure, 8 or 10 in. Low Pressure

Accessories

Actuator Series	Replacement Diaphragm
D-3153 Series	D-3153-600
D-3244 and D-3246 Series	D-3244-615

Technical Specifications

D-3153, D-3244, D-3246 Pneumatic Actuators for VF Series Butterfly Valves	
Maximum Control Pressure	25 psig (175 kPa) Maximum Except D-3153 without Positioner, 30 psig (210 kPa) Maximum
Temperature Limits	-20°F to 150°F (-29°C to 66°C)
Available Spring Range	8 psig to 13 psig (56 kPa to 91 kPa)
Air Connection	1/8 in. NPT Barbed Fitting for 5/32 in. or 1/4 in. O.D. Poly tubing



Two-Way VF Series Butterfly Valve with D-3153 Actuator

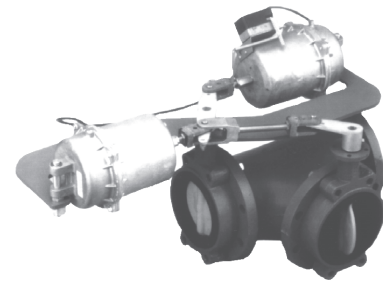

Three-Way VF Series Butterfly Valve with Tandem D-3246 Actuators

D-4070 Pneumatic Piston Damper Actuator

Description

The D-4070 Two-Stage Pneumatic Actuator is a multipurpose positioning device used to accurately position small dampers primarily on unit ventilators, VAVs, terminal units, and small ventilating dampers in response to output signals of a pneumatic controller or electro-pneumatic transducer.

The D-4070 is specifically designed to provide ASHRAE Cycle II and W control of unit ventilators where a minimum of outdoor air (15 to 50%) is admitted during the heating and ventilating stage and gradually increased to 100%, if needed, during the cooling and ventilating stage.

The D-4070 is a direct replacement for existing D-3070 actuators and a functional replacement for older D-255 actuators.

Refer to the *D-4070 Two-Stage Pneumatic Actuator Product Bulletin (LIT-2681082)* for important product application information.

Features

- two-way swivel connection ensures non-binding movement and full power delivery
- glass-reinforced polymer housing, which is lightweight and corrosion- and chemical-resistant

- telescoping linkage for fast and flexible installation
- economical because has two springs for two-stage operation, which function as two separate actuators
- designed to provide ASHRAE Cycle 11 and W controls of unit ventilators

Applications

The D-4070 has a first-stage nominal spring range of 3 psig to 6 psig (21 kPa to 42 kPa) and can be furnished with a second-stage spring range of either 9 psig to 12 psig (63 kPa to 84 kPa) or 11 psig to 14 psig (77 kPa to 98 kPa). The control air pressure for normal HVAC operation is 0 psig to 20 psig. The total stroke of the D-4070 is 2-3/4 in. (70 mm) and is adjustable from 0% to 50% during the first stage of operation.

The D-4070 incorporates several internal and external features that add functional flexibility. A two-way swivel connection on the actuator cylinder head provides nonbinding movement. All actuators have a telescoping piston rod for easy linkage of the damper for attachment points up to 8-3/4 in. (214 mm) away from the face of the actuator. A swivel ball joint and slotted crankarm connector are furnished on all actuators for optional

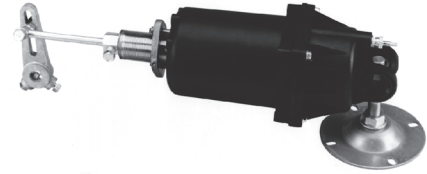

D-4070 Pneumatic Piston Damper Actuator

methods of linkage to the damper.

When used with proportional control, the damper size is limited by the torque requirement.

Repair Information

If the D-4070 Pneumatic Actuator fails to operate within its specifications, replace the unit. For a replacement actuator, contact the nearest Johnson Controls® representative.

Selection Chart¹

Code Number	Nominal Spring Range, psig (kPa)
D-4070-1	3 to 6 (21 to 42) First Stage, 9 to 12 (63 to 84) Second Stage with Auxiliary Mounting Bracket
D-4070-2	3 to 6 (21 to 42) First Stage, 11 to 14 (35 to 70) Second Stage with Auxiliary Mounting Bracket
D-4070-6001	3 to 6 (21 to 42) First Stage, 9 to 12 (63 to 84) Second Stage Body Only
D-4070-6002	3 to 6 (21 to 42) First Stage, 11 to 14 (35 to 70) Second Stage Body Only

1. Check your UV standard equipment sheets for the various models for the unit ventilator manufacturers. When a unit ventilator manufacturer specifies a D-4070, be sure to select the one that is designed for that unit.

Technical Specifications

D-4070 Pneumatic Piston Damper Actuator	
Stroke	2-3/4 in. (70 mm)
Control Air Pressure	0 psig to 20 psig for HVAC, 25 psig (171 kPa) Maximum
Air Connections	1/8 in. NPT Straight Barbed Fitting for 1/4 in. O.D. Poly tubing (Furnished)
Ambient Storage Condition	-20°F to 150°F (-29°C to 66°C)
Ambient Operating Conditions	35°F to 150°F (2°C to 66°C)
Effective Diaphragm Area	6.7 in ² (45 cm ²)
Housing Material	Glass-Reinforced Polymer, UL 94 HB Flame Class Rating
Diaphragm Material	Synthetic Elastomer
Dimensions	3-7/8 in. Diameter x 9-15/16 in. Long
Shipping Weight	3.5 lb (1.6 kg)

Accessories

Code Number	Description	Weight, lb (kg)
D-3073-105	Mounting Post Kit, 5 per Kit	0.5 (0.23)
D-3073-604	Ball Joint - Weather Resistant	0.5 (0.23)
D-3153-103	Rod - 8-3/4 in. (222 mm) Replacement	1.0 (0.45)
D-3153-106	Auxiliary Mounting Bracket	1.0 (0.45)
D-3153-111	E-Rings for Pivot Post, 10 per Kit	0.5 (0.23)
D-3153-112	Mounting Nuts for Pivot Post, 10 per Kit	0.5 (0.23)
DMPR-KC050	Crankarm: 7/16 in. Shaft Radius Adjustable to 2-3/4 in. Radius	0.5 (0.23)
DMPR-KC051	Crankarm: 3/8 in. Shaft Radius Adjustable to 2-3/4 in. Radius	0.5 (0.23)
DMPR-KC053	Crankarm: 1/2 in. Shaft Radius Adjustable to 2-3/4 in. Radius	0.5 (0.23)
DMPR-KC054	Blade Arm Kit	1.3 (0.59)
DMPR-KC102	Rod - 4 ft (122 cm)	2.0 (0.91)
DMPR-KC251	Universal Mounting Bracket	3.5 (1.13)
DMPR-KC300	Swivel Ball Joint, 10 per Kit	0.5 (0.23)

Maximum Force¹ Values at 20 psig (140 kPa) Supply

First-Stage Spring Range, psig (kPa)	Second-Stage Spring Range, psig (kPa)	Stroke	Force, lb (Newton)	Torque Output for 90° Rotation
3 to 6 (21 to 42)	9 to 12 (63 to 84)	Power	53.6 (239)	73.7 lb-in (8.4 N·m)
		Return	20.1 (89)	27.6 lb-in (3.1 N·m)
3 to 6 (21 to 42)	11 to 14 (77 to 98)	Power	40.2 (179)	55.3 lb-in (6.3 N·m)
		Return	20.1 (89)	27.6 lb-in (3.1 N·m)

1. Force calculated using 6.7 lb/psig available actuator force

D-4073 Pneumatic Piston Damper Actuator

Description

The D-4073 Pneumatic Actuator is a multipurpose positioning device used to accurately position small dampers primarily on unit ventilators, VAVs, terminal units, and small ventilating dampers in response to output signals of a pneumatic controller or electro-pneumatic transducer.

The actuator is also recommended for use on other airflow control dampers, in interior locations, up to a maximum area of 6.75 sq. ft for proportional volume control and 11.7 sq. ft for two-position actuation, provided that the torque requirements are compatible with the specific application.

The D-4073 is a direct replacement for existing D-3073 actuators and a functional replacement for former D-251 actuators.

Refer to the *D-4073 Pneumatic Actuator Product Bulletin (LIT-2681074)* for important product application information.

Features

- two-way swivel connection ensures non-binding movement and full power delivery
- glass-reinforced polymer housing, which is lightweight and corrosion- and chemical-resistant
- telescoping linkage for fast and flexible installation

Applications

When an 8 psig to 13 psig spring range is used with proportional control, the damper size is limited to 6.75 sq. ft maximum. As a two-position control, damper size is limited to 11.7 sq. ft.

Three nominal spring ranges are available: 3 psi to 7 psi, 5 psi to 10 psi, and 8 psi to 13 psi. The control air pressure for normal HVAC operation is 0 psig to 20 psig.

The D-4073 incorporates several internal and external features that add functional flexibility. A two-way swivel connection on the actuator cylinder head provides non-binding movement. All actuators have a telescoping piston rod for easy linkage of the damper for attachment points up to 8-3/4 in. (222 mm) away from the face of the actuator. A swivel ball joint and slotted crankarm connector are furnished on all actuators for optional methods of linkage to the damper.

A stop screw kit is available for special applications to limit the power stroke of the actuator when required. A 4 ft (122 cm) linkage rod is also available for special applications to reach extended linkage when required.

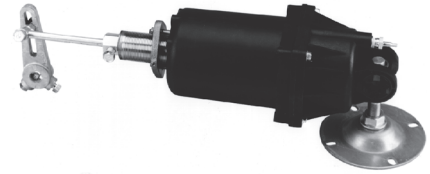

D-4073 Pneumatic Piston Damper Actuator

Where precision sequential operation is desired, or additional positioning power is necessary, use a D-9502 pilot positioner. Up to four more D-4073 actuators may be slaved from one pilot positioner for coupled dampers.

Repair Information

If the D-4073 Pneumatic Actuator fails to operate within its specifications, replace the unit. For a replacement actuator, contact the nearest Johnson Controls® representative.

Selection Chart

Code Number	Nominal Spring Range, psig (kPa)
D-4073-1	8 to 13 (56 to 91) with D-9502 and Universal Mounting Bracket
D-4073-2	8 to 13 (56 to 91) with Universal Mounting Bracket
D-4073-3	5 to 10 (35 to 70) with Universal Mounting Bracket
D-4073-4	8 to 13 (56 to 91) with D-9502 and Auxiliary Mounting Bracket
D-4073-5	8 to 13 (56 to 91) with Auxiliary Mounting Bracket
D-4073-6	5 to 10 (35 to 70) with Auxiliary Mounting Bracket
D-4073-7	3 to 7 (21 to 49) with Auxiliary Mounting Bracket
D-4073-6001	3 to 7 (21 to 49) Body Only
D-4073-6002	5 to 10 (35 to 70) Body Only
D-4073-6003	8 to 13 (56 to 91) Body Only

Accessories

Code Number	Description	Weight, lb (kg)
D-3073-100	Rubber Boot Kit (Includes Ball Joint and Cover)	0.2 (0.10)
D-3153-104	Stop Screw Kit	0.5 (0.23)
D-3073-105	Mounting Post Kit, 5 per Kit	0.5 (0.23)
D-3073-604	Ball Joint - Weather Resistant	0.5 (0.23)
D-3153-103	Rod - 8-3/4 in. (222 mm) Replacement	1.0 (0.45)
D-3153-106	Auxiliary Mounting Bracket	1.0 (0.45)
D-3153-111	E-rings for Pivot Post, 10 per Kit	0.5 (0.23)
D-3153-112	Mounting Nuts for Pivot Post, 10 per Kit	0.5 (0.23)
DMPR-KC050	Crankarm: 7/16 in. Shaft Radius Adjustable to 2-3/4 in. Radius	0.5 (0.23)
DMPR-KC051	Crankarm: 3/8 in. Shaft Radius Adjustable to 2-3/4 in. Radius	0.5 (0.23)
DMPR-KC053	Crankarm: 1/2 in. Shaft Radius Adjustable to 2-3/4 in. Radius	0.5 (0.23)
DMPR-KC054	Blade Arm Kit	1.3 (0.59)
DMPR-KC102	Rod - 4 ft (122 cm)	2.0 (0.91)
DMPR-KC251	Universal Mounting Bracket	3.5 (1.13)
DMPR-KC300	Swivel Ball Joint	0.5 (0.23)
D-9502-12	Proportional Pilot Positioner Kit	2.0 (0.91)

Note: Refer to reference bulletins in the *Pneumatic Control Manual (FAN 717.1)* for models applying to unit ventilators and other types of units.

D-4073 Pneumatic Piston Damper Actuator (Continued)

Technical Specifications

D-4073 Pneumatic Piston Damper Actuator	
Stroke	3 in. (76 mm)
Control Air Pressure	0 psig to 20 psig for HVAC 25 psig (175 kPa) Maximum
Air Connections	1/8 in. NPT Straight Barbed Fitting for 5/32 or 1/4 in. O.D. Polytubing (Furnished)
Ambient Operating Conditions	-20°F to 150°F (-29°C to 66°C)
Effective Diaphragm Area	6.7 in ² (45 cm ²)
Housing Material	Glass-Reinforced Polymer, UL 94 HB Flame Class Rating
Dimensions	3-7/8 in. Diameter x 11 in. Long
Shipping Weight, lb (kg)	D-4073-1 7.9 (3.6) D-4073-3 6.4 (2.9) D-4073-5 4.9 (2.2) D-4073-7 4.9 (2.2) D-4073-2 6.4 (2.9) D-4073-4 6.4 (2.9) D-4073-6 4.9 (2.2)

Maximum Force¹ Values at 20 psig (140 kPa) Supply

Spring Range, psig (kPa)	Stroke	Force, lb (Newton)	Torque Output for 90° Rotation
8 to 13 (56 to 91)	Power	47 (209)	71 lb·in (8.0 N·m)
	Return	54 (240)	81 lb·in (9.1 N·m)
5 to 10 (35 to 70)	Power	67 (298)	101 lb·in (11.3 N·m)
	Return	34 (151)	51 lb·in (5.8 N·m)
3 to 7 (21 to 49)	Power	87 (388)	131 lb·in (14.8 N·m)
	Return	20 (89)	30 lb·in (3.4 N·m)

1. Force calculated using 6.7 lb/psig available actuator force

DS-3062 High-Temperature Pneumatic Piston Damper Actuator

Description

The DS-3062 Pneumatic Actuator is a multipurpose positioning device used to accurately position small dampers in high-temperature smoke applications (such as Johnson Controls® SD-1300 Series) in response to output signals of a pneumatic controller or electro-pneumatic transducer.

The DS-3062 can be used with other dampers up to a maximum area of 4 square feet for proportional volume control and 6-1/4 square feet for two-position actuation, provided that the torque requirements are compatible with the specific application.

Refer to the *DS-3062 Pneumatic Actuator Product Bulletin (LIT-2681070)* for important product application information.

Features

- high power-to-size ratio for locations in confined spaces
- all-aluminum housing, which is lightweight and non-combustible
- telescoping linkage for fast and flexible installation
- front or rear mounting options for flexible mounting configurations

Applications

When used with proportional control, the damper size is limited to 4 square feet maximum. As a two-position control, damper size is limited to 6-1/2 square feet. As determined by testing using Johnson Controls® D-1300 dampers, width and height are limited to 30 in. (76.2 cm) maximum.

The nominal spring range is 8 to 13 psi. The control air pressure for normal HVAC operation is 0 psig to 20 psig. The minimum control pressure for safety damper ventilation mode is 20 psi with the maximum pressure of 30 psi. When used for both proportional and smoke applications, a separate air signal should be provided to override normal HVAC operations and enact safety damper functions.

Note: The DS-3062-1 is not able to be configured for frame mounting in normally open damper applications.

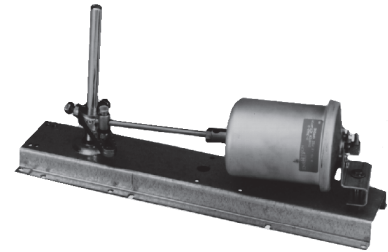

DS-3062 Pneumatic Actuator

Repair Information

If the DS-3062 Pneumatic Actuator fails to operate within its specifications, replace the unit. For a replacement actuator, contact the nearest Johnson Controls representative.

Selection Chart

Code Number	Nominal Spring Range, psig (kPa)
DS-3062-1	8 to 13 (56 to 91) with Universal Mounting Kit

Accessories

Code Number	Description
DMPR-KC053	Crankarm: 1/2 in. Adjustable to 2-3/4 in. Radius
DMPR-KC300	Swivel Ball Joint
D-3062-106	Rod: 1/4-20 Threaded One End
D-3073-604	Ball Joint: Weather Resistant

Technical Specifications

DS-3062 High-Temperature Pneumatic Piston Damper Actuator	
Stroke	2 in. (51 mm)
Control Air Pressure	0 psig to 20 psig for HVAC 20 psig (137 kPa) Minimum for Safety Damper Ventilation Mode 30 psig (205 kPa) Maximum
Air Connections	Compression Fitting for 1/4 in. O.D. Copper Tubing
Ambient Operating Conditions (HVAC)	-20°F to 150°F (-29°C to 66°C)
Materials	Body: Aluminum Diaphragm: Synthetic Elastomer
Effective Diaphragm Area	6.6 in. ² (43 cm ²)
Dimensions	3-3/16 in. Diameter x 6-13/16 in. Long
Shipping Weight	DS-3062-1: 5.2 lb (2.4 Kg) DS-3062-2: 2.3 lb (1.0 Kg)

Maximum Actuator Force¹ at 20 psig (140 kPa)

Nominal Spring Range, psig (kPa)	Stroke	Force, lb (Newton)	Torque Output at 90° Rotation
8 to 13 (56 to 91)	Power	46.2 (206)	46.2 lb-in (5.22 N·m)
	Return	52.8 (235)	52.8 lb-in (5.96 N·m)

1. Force calculated using 6.6 lb/psig available actuator force

DS-3153 High-Temperature Pneumatic Piston Damper Actuator

Description

The DS-3153 Pneumatic Actuator is a multipurpose positioning device used primarily for operating smoke ventilating dampers in response to the output signals of a pneumatic controller or electro-pneumatic transducer during life safety applications.

The DS-3153 can be used with dampers up to a maximum area of 16 square feet for proportional volume control and 25 square feet for two-position actuation, provided that the torque requirements are compatible with the specific application.

Refer to the *DS-3153 Pneumatic Actuator Product Bulletin (LIT-2681072)* for important product application information.

Features

- high-temperature pilot positioner available for additional positioning power and sequential control
- all metal bearings for high-temperature exposure
- all-aluminum housing, which is lightweight and non-combustible

- telescoping linkage for fast and flexible installation
- two-way swivel head to ensure full power delivery
- 3-year warranty to provide confidence of company standing behind product

Applications

When used with proportional control, the damper size is limited to 16 square feet maximum. As a two-position control, the damper size is limited to 25 square feet.

The nominal spring range is 8 psi to 13 psi. The control air pressure for normal HVAC operation is 0 psig to 20 psig. The minimum control pressure for safety damper functions is 20 psig with the maximum pressure of 30 psig. When used for both proportional and safety applications, a separate air signal should be provided to override normal HVAC operation and cause safety damper functions.

Where precision sequential operation is desired, or additional positioning power is necessary, a pilot positioner is available.

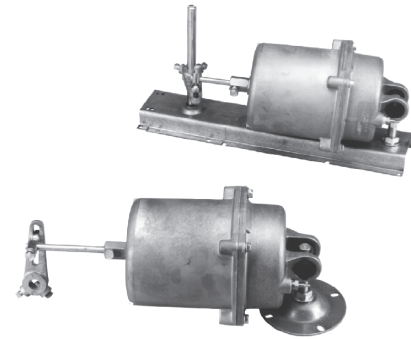

DS-3153 High-Temperature Pneumatic Piston Damper Actuator

Repair Information

If the DS-3153 Pneumatic Actuator fails to operate within its specifications, replace the unit. For a replacement actuator, contact the nearest Johnson Controls® representative.

Selection Chart

Code Number	Nominal Spring Range, psig (kPa)
DS-3153-1	8 to 13 (56 to 91) with Pilot Positioner and Universal Mounting Bracket
DS-3153-2	8 to 13 (56 to 91) with Universal Mounting Bracket
DS-3153-4	8 to 13 (56 to 91) with Pilot Positioner and Auxiliary Mounting Bracket
DS-3153-5	8 to 13 (56 to 91) with Auxiliary Mounting Bracket

Accessories

Code Number	Description	Shipping Weight, lb (Kg)
D-3073-100	Rubber Boot Kit	0.2 (0.91)
D-3073-604	Ball Joint Weather Resistant	0.3 (0.11)
DMPR-KC054	Blade Arm Kit	1.0 (0.45)
DMPR-KC051	Crankarm 3/8 in. Adjustable to 2-3/4 in. Radius	0.5 (0.23)
DMPR-KC050	Crankarm 7/16 in. Adjustable to 2-3/4 in. Radius	0.5 (0.23)
DMPR-KC102	Linkage Rod 4 ft (122 cm)	2.0 (0.91)
D-3153-103	Linkage Rod Replacement	1.0 (0.45)

Technical Specifications

DS-3153 High-Temperature Pneumatic Piston Damper Actuator			
Stroke	3 in. (76 mm)		
Control Air Pressure	0 psig-20 psig for HVAC 20 psig (137 kPa) minimum for safety damper functions 30 psig (205 kPa) maximum		
Force at 20 psig (140kPa) Supply	Stroke	Force, lb (Newton)	Torque Output at 90° Rotation
	Power	105 (467)	158 lb-in (18 N-m)
	Return	120 (534)	180 lb-in (20 N-m)
Air Connections	Compression fitting for 1/4 in. O.D. copper tubing (furnished)		
Ambient Operating Conditions	-20°F to 150°F (-29°C to 66°C)		
Effective Diaphragm Area	15 in ² (97 cm ²)		
Materials	Body - die cast aluminum; diaphragm - synthetic elastomer		
Dimensions	5-1/14 in. diameter x 10 in. long		
Shipping Weight, lb (Kg)	DS-3153-1 10.5 (4.8) DS-3153-4 10.5 (4.8)	DS-3153-2 10.5 (4.8) DS-3153-5 8.5 (3.9)	

D-9502 Pneumatic Damper Actuator Positioner

Description

The D-9502 Pneumatic Damper Actuator Positioners are precision relay devices used to adjust and maintain damper actuators in exact positions on those applications requiring precise or otherwise special damper positioning.

Refer to the *D-9502 Pneumatic Damper Actuator Positioner Product Bulletin (LIT-1628399P)* for important product application information.

Features

- provides dynamic stabilization and/or sequential control
- includes mounting bracket for direct attachment to actuator body

Selection Chars

D-9502 Pneumatic Damper Actuator Positioner

Code Number	Description
D-9502-5	D-3244 Actuator
D-9502-8	D-3153 Actuator
D-9502-9	D-3153 Actuator, Two-Stage
D-9502-12	D-4073 Actuator

Pilot Positioners for Obsolete Actuators

Code Number	Description
D-9502-5	D-251 No. 5 Actuator or D-3246

Accessories and Maintenance Parts

Code Number	Description	Weight, lb (kg)
D-9502-609	Spring for Use with D-3153, D-3073, and D-4073	0.8 (0.36)
D-9502-610	Spring for Use with D-3244	0.8 (0.36)
D-9502-611	Diaphragm Repair Kit, Package Quantity of 6	0.8 (0.36)
D-9502-612	Spring for Use with D-3246	0.8 (0.36)
D-9502-604	Operating Span Lever Arm Assembly	0.8 (0.36)
C-9506-1	Positioner Movement Complete Less Springs and Operating Span Lever Arm Assembly	1.3 (0.59)

Applications

The pneumatic damper actuator pilot positioner provides dynamic stabilization and/or sequential control of pneumatic damper actuators. It is available factory installed on D-4070, D-4073, D-3153, and DS-3153 Damper Actuators. On D-3153 Series Actuators, a special positioner mounting kit (D-9502-9) is available for changing basic D-9502 positioner control to two-stage operation.

Depending on the type of actuator used, up to three additional actuators may be controlled by a single positioner/actuator assembly; for example, multiple actuators modulating large or coupled dampers.

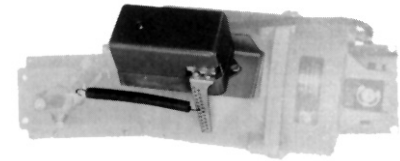

D-9502 Pneumatic Damper Actuator Positioner

Repair Information









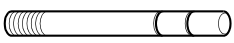

If the D-9502 Pneumatic Actuator Positioner fails to operate within its specifications, replace the unit. For a replacement positioner, contact the nearest Johnson Controls® representative.

Technical Specifications

D-9502 Pneumatic Damper Actuator Positioner	
Starting Point	Adjustable from 2 psig to 12 psig (14 kPa to 84 kPa)
Operating Span	Adjustable from 3 psi to 13 psi (21 kPa to 91 kPa)
Maximum Supply Air Pressure	25 psig (175 kPa) 20 psig (140 kPa) for D-9504-13 only Air supply must be clean, dry, and oil free.
Air Consumption	5 SCIM (1.4 mL/s)
Output Flow Capacity	1,000 SCIM (273 mL/s) 1,600 SCIM (437 mL/s) D-9502-13 only
Air Connections	Barbed fittings for 5/32 or 1/4 in. O.D. polytubing Supply S and pilot P : barbed fittings for 5/32 or 1/4 in O.D. polytubing D-9502-13 only Output O : compression fitting for 1/4 in. O.D. copper tubing D-9502-13 only
Ambient Operating Conditions	-20°F to 150°F (-29°C to 66°C) -20°F to 250°F (-29°C to 121°C) D-9502-13 only based on UL testing for 30 minutes and should not be considered for continuous operation
Effective Diaphragm Area	15 in ² (97 cm ²)
Materials	Body - die cast aluminum with irradiate finish Cover - Noryl® (D-9502-13 die cast zinc) Diaphragm - fabric-reinforced rubber
Dimensions (H x W x D)	2-1/4 in. x 3-7/8 in. x 2-23/32 in.
Shipping Weight, lb (Kg)	2.0 (0.91)
Agency Listing	UL Recognized component to 350°F (176°C) with compression fitting for copper tubing File No. R15581

Hardware for Pneumatic Damper Actuators

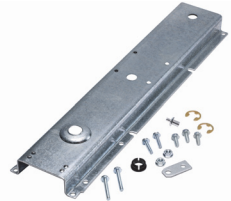
Selection Chart

Figure	Code Number	Description and Use
	D-3073-101 D-3153-104	Stop Screw Kit for D-4073 Actuator, Kit Includes Two No. 10-24 in. x 3 in. Stop Screws and Two 10-24 Nuts Stop Screw Kit for D-3153 Actuator, Kit Includes Two 1/4-20 in. x 3 in. Stop Screws and Two 1/4-20 Nuts
	D-3153-103 DMPR-KC102	Linkage Rod Replacement for D-3070, D-3073, D-3153, D-4070 or D-4073 Actuators 8 in., 5/16 in. Diameter 48 in., 5/16 in. Diameter
	D-3153-106	4 in. Auxiliary Mounting Bracket for D-3070, D-3073, D-3153, D-4070 or D-4074 Actuators
	D-3073-105 D-3153-110	Pivot Post Kit for D-4073, 5 per Kit Pivot Post Kit for D-3153, 5 per Kit
	D-3153-111	E-Rings for Pivot Post 10 per Kit
	D-3153-112	Mounting Nuts for Pivot Post 10 per Kit
	D-265-602 D-9502-5 D-9502-8 D-9502-9 D-9502-5 ¹ D-9502-12	Positioner Kit for Field Mounting on Damper Actuators Kit Includes: Positioner, Mounting Plate, Spring, and Mounting Hardware. Kit Does Not Include Tubing. Kit for: Spring for No. 4, Package of 6 No. 5 or D-3244 Actuator D-3153 Actuator D-3153 Two-Stage D-3246 D-3073, D-4073
	D-3000-1077 D-251-705	Connection Head, 5/16-30 Thd, for Upgrading No. 2 D-251 and D-3000 Actuators to Ball Joint Linkage Connection Head, 3/8-20 Thd, for Upgrading No. 3 D-251 to Ball Joint Linkage
 DMPRKC050 DMPRKC052	DMPR-KC050 DMPR-KC051 DMPR-KC052 DMPR-KC053	Crankarm (Slotted) for D-3070, D-3073, D-3153, D-4070 or D-4073 Actuators For 7/16 in. Shaft, Radius Adjustable to 2-3/4 in. For 3/8 in. Shaft, Radius Adjustable to 2-3/4 in. For 1/2 in. Shaft, Radius Adjustable to 1-11/16 in. For 1/2 in. Shaft, Radius Adjustable to 2-3/4 in.
	DMPR-KC251	Universal Mounting Bracket for D-3070, D-3073, D-3153, D-4073 or D-4074 Actuators
	D-3153-608	Actuator Swivel Bearing Kit for D-3070, D-3073, D-3153, D-4070 or D-4073 Actuators 5 per Kit
Replacement Diaphragms for discontinued actuators	D-251-6000 D-251-6002 D-251-6003 D-251-6004	Diaphragm for No. 3, Package of 25 Diaphragm for No. 2, Package of 12 Diaphragm for No. 4, Package of 12 Diaphragm for No. 6, Package of 6
 D-9999-152 D-9999-153	D-9999-152 D-9999-153	Clevis Pin Kit, 10 per Kit Twist Lock Clip Kit, 100 per Kit

1. Also order spring number D-9502-612 and Pilot Spring Bracket number D-9502-100.

PP1 Series Piping Packages for VG1000 Series Ball Valves

Description

PP1 Series Piping Packages are designed to provide an easier way to deploy control valve solutions to a job site. Built around Johnson Controls® field-proven VG1000 Series Ball Valves using standard components, each piping package is tested under 100 psig (689 kPa) for 24 hours and then reduced to 40 psig (276 kPa) before shipping to ensure leak-free control valve solutions.

Johnson Controls piping packages are manufactured by United Association of Journeymen & Apprentices of the Plumbing and Pipe Fitting Industry of USA and Canada pipe fitters and provide defect-free solutions for 3/4 to 1-1/4 in. pipe sizes for both two-way and three-way applications.

Johnson Controls piping packages significantly reduce site labor. A piping package can be secured using the ProPress® fitting system or by soldering to fasten it to the piping infrastructure.

Refer to the *PP1 Series Piping Packages for VG1000 Series Ball Valves Product Bulletin (LIT-12011974)* for important product application information.

Features

- Assembly in a Factory Environment Following the Recommended Component Manufacturer Procedure
- 100% Tested under 100 psig (689 kPa) for 24 hours
- VG1000 Series Ball Valves
- Manufactured by United Association of Journeymen & Apprentices of the Plumbing and Pipe Fitting Industry of USA and Canada Pipe Fitters

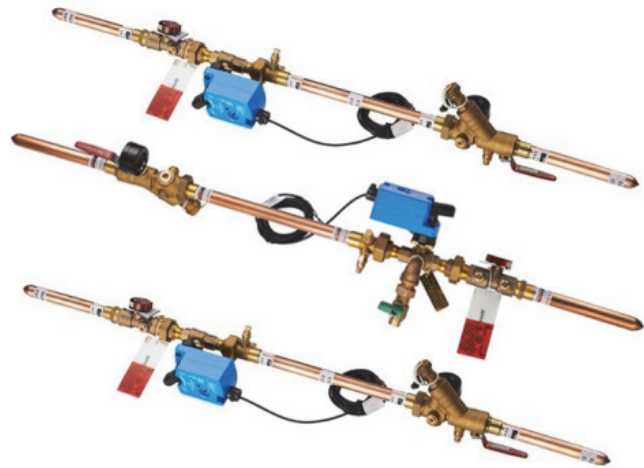

PP1 Series Piping Packages

Repair Information

If the PP1 Series Piping Package fails to operate within its specifications, replace the unit. For a replacement piping package, contact the nearest Johnson Controls representative.

WARNING

This product is made of copper alloy, which contains lead. The product is therefore not to be used on drinking water.

WARNING

This product can expose you to chemicals including lead, which is known to the State of California to cause cancer, birth defects, or other reproductive harm. For more information, go to www.P65Warnings.ca.gov.

WARNING: BRASS MAY CONTAIN LEAD

To fulfill our obligations towards Article 33, in accordance to the European REACH Regulation No 1907/2006 EC, we hereby inform you that this article contains the following Substances of Very High Concern mentioned on the Candidate list:

- Lead

PP1 Series Piping Packages for VG1000 Series Ball Valves (Continued)

Selection Charts

Two-Way Automatic Flow Control Valve Models

Code Number	GPM	Pip Size, in.	Supply Pipe	Return Pipe				
			Y-Strainer with a Union End Ball Valve	Automatic Flow Control Valve	Union Connection	VG1000 Series Ball Valve		
						Size, in. (DN)	Cv	
PP12BA005-1	0.5	3/4	UBY 3/4"S x 3/4"S	AC 3/4"S x 1/2"M	UA 3/4"S x 1/2"M	1/2 (DN15)	1.2	
PP12BA010-1	1						1.2, 1.9, 2.9	
PP12BA015-1	1.5							
PP12BA020-1	2						1.2, 1.9, 2.9, 4.7	
PP12BA025-1	2.5							
PP12BA030-1	3							
PP12BA035-1	3.5						2.9, 4.7, 7.4	
PP12BA040-1	4							
PP12BA045-1	4.5							
PP12BA050-1	5						5.5	7.4, 7.4, 11.8
PP12BA055-1	5.5							
PP12CA060-1	6	1	UBY 1"S x 1"S	AC 1"S x 3/4"M	UA 1"S x 3/4"M	3/4 (DN20)	4.7, 7.4	
PP12CA070-1	7						4.7, 7.4, 11.8	
PP12CA080-1	8							
PP12CA090-1	9							
PP12CA100-1	10							
PP12DA110-1	11	1-1/4	UBY 1-1/4"S x 1 1/4"	AC 1-1/4"S x 1"M	UA 1-1/4"S x 1"M	1 (DN25)	7.4, 11.8, 18.7	
PP12DA120-1	12						11.8, 18.7	
PP12DA130-1	13							
PP12DA140-1	14							
PP12DA150-1	15							
PP12DA160-1	16							
PP12DA170-1	17							
PP12DA180-1	18							
PP12DA190-1	19							
PP12DA200-1	20							
PP12DA210-1	21							
PP12DA220-1	22							

Two-Way Manual Flow Control Valve Models

Code Number	GPM	Pipe Size, in.	Supply Pipe	Return Pipe			
			Y-Strainer with a Union End Ball Valve	Manual Balancing Valve	Union Connection	VG1000 Series Ball Valve	
						Size, in. (DN)	Cv
PP12BM001-1	0.5-7	3/4	UBY 3/4"S x 3/4"S	MC 3/4"S x 1/2"M	UA 3/4"S x 1/2"M	1/2 (DN15)	1.2, 1.9, 2.9, 4.7
PP12CM001-1	1.5-14	1	UBY 1"S x 1"S	MC 1"S x 1/2"M	UA 1"S x 1/2"M		3/4 (DN20)
PP12CM002-1				MC 1"S x 3/4"M	UA 1"S x 3/4"M	4.7, 7.4, 11.7	
PP12DM001-1	4.5-31	1-1/4	UBY 1 1/4"S x 1 1/4"S	MC 1-1/4"S x 1"M	UA 1 1/4"S x 1"M	1 (DN25)	

The performance specifications are nominal and conform to acceptable industry standards. For applications at conditions beyond these specifications, consult the local Johnson Controls office. Johnson Controls shall not be liable for damages resulting from misapplication or misuse of its products. © 2019 Johnson Controls www.johnsoncontrols.com

PP1 Series Piping Packages for VG1000 Series Ball Valves (Continued)

Three-Way Manual Flow Control Valve Models

Code Number	GPM	Pipe Size, in.	Supply Pipe	Return Pipe				Bypass Pipe
			Y-Strainer with a Union End Ball Valve	Manual Balancing Valve	Union Connection	VG1000 Series Ball Valve		Ball Valve
						Size, in. (DN)	Cv	
PP18BM001-1	0.5-7	3/4	UBY 3/4"S x 3/4"S	MC 3/4"S x 1/2"M	UA 3/4"S x 1/2"M	1/2 (DN15)	1.2, 1.9, 2.9, 4.7	UBV 1/2"S x 1/2"M
PP18CM001-1	1.5-14	1	UBY 1"S x 1"S	MC 1"S x 1/2"M	UA 1"S x 1/2"M		3/4 (DN20)	4.7, 7.4
PP18CM002-1				MC 1"S x 3/4"M	UA 1"S x 3/4"M	4.7, 7.4, 11.7		
PP18DM001-1	4.5-31	1-1/4	UBY 1 1/4"S x 1 1/4"S	MC 1-1/4"S x 1"M	UA 1 1/4"S x 1"M	1 (DN25)	7.4, 11.7, 18.7	UBV 1"S x 1"M

Technical Specifications

Y-Strainer with a Union End Ball Valve	
Product Code	UBY
Body	Forged brass C37000
Ball	Full port chrome plated
Ball Seal	Teflon®
Stem	Explosion-proof
O-Rings	Ethylene propylene diene monomer (EPDM)
Filter Screen	20 mesh, stainless steel
Maximum Seat Pressure Rating	400 psig (2,758 kPa)
Operating Temperature	-4°F to 250°F (20°C to 121°C)

Union Connection	
Product Code	UA
Body	Forged brass C37000
O-Ring	EPDM
Maximum Pressure	400 psig
Maximum Operating Temperature	-4°F to 250°F (20°C to 121°C)

Combination Commissioning Valve and Automatic Flow Limiting Valve	
Product Code	AC
Body	Brass C37710
Ball	Chrome plated brass C37710
Ball Seat	Teflon
O-Ring	EPDM
Diaphragm	Reinforced EPDM
Spring	Stainless steel
Tail Piece, Nut	Brass
Stem	Blowout-proof
Maximum Seat Pressure Rating	400 psig (2,758 kPa)
Operating Temperature	-4°F to 250°F (20°C to 121°C)
Flow Rate Accuracy	±5%

The performance specifications are nominal and conform to acceptable industry standards. For applications at conditions beyond these specifications, consult the local Johnson Controls office. Johnson Controls shall not be liable for damages resulting from misapplication or misuse of its products. © 2019 Johnson Controls www.johnsoncontrols.com

PP1 Series Piping Packages for VG1000 Series Ball Valves (Continued)

Cartridge (Included in Combination Commissioning Valve and Automatic Flow Limiting Valve)	
Body	Brass C36000 or equivalent
Spring	304 stainless steel
Diaphragm and O-Ring	EPDM
Orifice	Brass C36000 or equivalent

Calibrated Manual Balancing Valve with Shut-Off Ball Valve	
Product Code	MC
Body	Brass ASTM B584-844
Ball	Brass ASTM B16 C36000
Ball Seal	Glass and carbon-filled Teflon
Stem O-Ring	EPDM
Maximum Working Pressure	300 psig (2,069 kPa)
Operating Temperature	-4°F to 250°F (20°C to 121°C)

Pressure Gauge	
Case	Black painted steel
Dial	Black figures on white background
Tube and Sprocket	Bronze
Accuracy	ASME B40.100, Grade B, ±3.75% (0 to 25 psig [0 to 172 kPa]: 3%, 25 to 75 psig [172 to 517 kPa]: 2%, 75 to 100 psig [517 to 689 kPa]: 3%)
Operating Temperature	-40°F to 150°F (-40°C to 65°C)

Ball Valve (Three-Way Valve Models)	
Product Code	UBV
Body	Brass C37000
Handle	Chrome plated steel with plastic cover
Ball	Chrome plated
Ball Seal	Teflon
O-Ring	EPDM
Union Seal	Viton O-ring
Stem	Explosion-proof
Maximum Seat Pressure Rating	400 psig (2,758 kPa)
Operating Temperature	-4°F to 250°F (20°C to 121°C)

Pipe	
Copper Pipe	Type L

VG1000 Series Two-Way, Stainless Steel Trim, NPT End Connections Ball Valves with Spring-Return Electric Actuators without Switches

Description

VG1000 Series Ball Valves are designed to regulate the flow of hot or chilled water and, for some models, low pressure steam in response to the demand of a controller in HVAC systems. Available in sizes 1/2 through 2 in. (DN15 through DN50), this family of two- and three-way forged brass valves is factory or field mounted to Johnson Controls® VA9104, M9106, M9109, and M9100 Series Non-Spring-Return and VA9203 and VA9208 Series Spring-Return Electric Actuators for on/off, floating, or proportional control.

Refer to the *VG1000 Series Forged Brass Ball Valves Product Bulletin (LIT-977132)* for important product application information.

Features

- Forged Brass Body — provides 580 psig static pressure rating.
- 200 psi Closeoff Pressure Rating — provides tight shutoff.
- Graphite-Reinforced Polytetrafluoroethylene (PTFE) Seats — include 15% graphite-reinforced ball seals, providing better wear resistance.
- 300 Series Stainless Steel Ball and Stem Assembly — tolerates high-temperature water or 15 psi saturated steam with fluid temperatures of -22°F to 284°F (-30°C to 140°C) or where a higher degree of corrosion protection is desired.
- 500:1 Rangeability — provides accurate control under all load conditions.



VG1000 Series Two-Way, Spring-Return, Stainless Steel Ball and Stem Ball Valve Assemblies without End Switches

WARNING

This product is made of copper alloy, which contains lead. The product is therefore not to be used on drinking water.

Repair Information

If the VG1000 Series Ball Valve fails to operate within its specifications, replace the valve body, actuator, or entire assembly. For replacement parts, contact the nearest Johnson Controls representative.

WARNING

This product can expose you to chemicals including lead, which is known to the State of California to cause cancer, birth defects, or other reproductive harm. For more information, go to www.P65Warnings.ca.gov.

Selection Charts

Two-Way — Spring Return Valves — Without Switches (Not Rated for Steam Service) (Part 1 of 2)

Fluid Temperatures: -22 to 212°F (-30 to 100°C) Not Rated for Steam Service				AC 24 V			AC 85–264 V (VA9203) AC 120 V (VA9208)	
Valve	Size, in.	Cv	Closeoff psig	Floating	DC 0 to 10 V Proportional	On/Off	On/Off	
				Spring Return Open — Valve Normally Open				
				VA9203-AGA-2Z	VA9203-GGA-2Z	VA9203-BGA-2	VA9203-BUA-2	
VG1245AD	1/2	1.2 ¹	200	VG1245AD+923AGA	VG1245AD+923GGA	VG1245AD+923BGA	VG1245AD+923BUA	
VG1245AE		1.9 ¹		VG1245AE+923AGA	VG1245AE+923GGA	VG1245AE+923BGA	VG1245AE+923BUA	
VG1245AF		2.9 ¹		VG1245AF+923AGA	VG1245AF+923GGA	VG1245AF+923BGA	VG1245AF+923BUA	
VG1245AG		4.7 ¹		VG1245AG+923AGA	VG1245AG+923GGA	VG1245AG+923BGA	VG1245AG+923BUA	
VG1245AL		7.4 ¹		VG1245AL+923AGA	VG1245AL+923GGA	VG1245AL+923BGA	VG1245AL+923BUA	
VG1245AN		11.7		VG1245AN+923AGA	VG1245AN+923GGA	VG1245AN+923BGA	VG1245AN+923BUA	
VG1245BG	3/4	4.7 ¹	200	VG1245BG+923AGA	VG1245BG+923GGA	VG1245BG+923BGA	VG1245BG+923BUA	
VG1245BL		7.4 ¹		VG1245BL+923AGA	VG1245BL+923GGA	VG1245BL+923BGA	VG1245BL+923BUA	
VG1245BN		11.7		VG1245BN+923AGA	VG1245BN+923GGA	VG1245BN+923BGA	VG1245BN+923BUA	
VG1245CL	1	7.4 ¹	200	VG1245CL+923AGA	VG1245CL+923GGA	VG1245CL+923BGA	VG1245CL+923BUA	
VG1245CN		11.7 ¹		VG1245CN+923AGA	VG1245CN+923GGA	VG1245CN+923BGA	VG1245CN+923BUA	
VG1245CP		18.7		VG1245CP+923AGA	VG1245CP+923GGA	VG1245CP+923BGA	VG1245CP+923BUA	
				Spring Return Open — Valve Normally Open				
				VA9208-AGA-2	VA9208-GGA-2	VA9208-BGA-3	VA9208-BAA-3	
VG1245DN	1-1/4	11.7 ¹	200	VG1245DN+928AGA	VG1245DN+928GGA	VG1245DN+938BGA	VG1245DN+938BAA	
VG1245DP		18.7 ¹		VG1245DP+928AGA	VG1245DP+928GGA	VG1245DP+938BGA	VG1245DP+938BAA	
VG1245DR		29.2		VG1245DR+928AGA	VG1245DR+928GGA	VG1245DR+938BGA	VG1245DR+938BAA	
VG1245EP	1-1/2	18.7 ¹	200	VG1245EP+928AGA	VG1245EP+928GGA	VG1245EP+938BGA	VG1245EP+938BAA	
VG1245ER		29.2 ¹		VG1245ER+928AGA	VG1245ER+928GGA	VG1245ER+938BGA	VG1245ER+938BAA	
VG1245ES		46.8		VG1245ES+928AGA	VG1245ES+928GGA	VG1245ES+938BGA	VG1245ES+938BAA	
VG1245FR	2	29.2 ¹	200	VG1245FR+928AGA	VG1245FR+928GGA	VG1245FR+938BGA	VG1245FR+938BAA	
VG1245FS		46.8 ¹		VG1245FS+928AGA	VG1245FS+928GGA	VG1245FS+938BGA	VG1245FS+938BAA	
VG1245FT		73.7		VG1245FT+928AGA	VG1245FT+928GGA	VG1245FT+938BGA	VG1245FT+938BAA	

The performance specifications are nominal and conform to acceptable industry standards. For applications at conditions beyond these specifications, consult the local Johnson Controls office. Johnson Controls shall not be liable for damages resulting from misapplication or misuse of its products. © 2019 Johnson Controls. www.johnsoncontrols.com

VG1000 Series Two-Way, Stainless Steel Trim, NPT End Connections Ball Valves with Spring-Return Electric Actuators without Switches (Continued)

Two-Way — Spring Return Valves — Without Switches (Not Rated for Steam Service) (Part 2 of 2)

Fluid Temperatures: -22 to 212°F (-30 to 100°C) Not Rated for Steam Service				AC 24 V			AC 85–264 V (VA9203) AC 120 V (VA9208)	
Valve	Size, in.	Cv	Closeoff psig	Floating	DC 0 to 10 V Proportional	On/Off	On/Off	
Spring Return Closed — Valve Normally Closed								
				VA9203-AGA-2Z	VA9203-GGA-2Z	VA9203-BGA-2	VA9203-BUA-2	
VG1245AD	1/2	1.2	200	VG1245AD+943AGA	VG1245AD+943GGA	VG1245AD+943BGA	VG1245AD+943BUA	
VG1245AE		1.9 ¹		VG1245AE+943AGA	VG1245AE+943GGA	VG1245AE+943BGA	VG1245AE+943BUA	
VG1245AF		2.9 ¹		VG1245AF+943AGA	VG1245AF+943GGA	VG1245AF+943BGA	VG1245AF+943BUA	
VG1245AG		4.7 ¹		VG1245AG+943AGA	VG1245AG+943GGA	VG1245AG+943BGA	VG1245AG+943BUA	
VG1245AL		7.4 ¹		VG1245AL+943AGA	VG1245AL+943GGA	VG1245AL+943BGA	VG1245AL+943BUA	
VG1245AN		11.7		VG1245AN+943AGA	VG1245AN+943GGA	VG1245AN+943BGA	VG1245AN+943BUA	
VG1245BG	3/4	4.7 ¹	200	VG1245BG+943AGA	VG1245BG+943GGA	VG1245BG+943BGA	VG1245BG+943BUA	
VG1245BL		7.4 ¹		VG1245BL+943AGA	VG1245BL+943GGA	VG1245BL+943BGA	VG1245BL+943BUA	
VG1245BN		11.7		VG1245BN+943AGA	VG1245BN+943GGA	VG1245BN+943BGA	VG1245BN+943BUA	
VG1245CL	1	7.4 ¹	200	VG1245CL+943AGA	VG1245CL+943GGA	VG1245CL+943BGA	VG1245CL+943BUA	
VG1245CN		11.7 ¹		VG1245CN+943AGA	VG1245CN+943GGA	VG1245CN+943BGA	VG1245CN+943BUA	
VG1245CP		18.7		VG1245CP+943AGA	VG1245CP+943GGA	VG1245CP+943BGA	VG1245CP+943BUA	
Spring Return Closed — Valve Normally Closed								
				VA9208-AGA-2	VA9208-GGA-2	VA9208-BGA-3	VA9208-BAA-3	
VG1245DN	1-1/4	11.7 ¹	200	VG1245DN+948AGA	VG1245DN+948GGA	VG1245DN+958BGA	VG1245DN+958BAA	
VG1245DP		18.7 ¹		VG1245DP+948AGA	VG1245DP+948GGA	VG1245DP+958BGA	VG1245DP+958BAA	
VG1245DR		29.2		VG1245DR+948AGA	VG1245DR+948GGA	VG1245DR+958BGA	VG1245DR+958BAA	
VG1245EP	1-1/2	18.7 ¹	200	VG1245EP+948AGA	VG1245EP+948GGA	VG1245EP+958BGA	VG1245EP+958BAA	
VG1245ER		29.2 ¹		VG1245ER+948AGA	VG1245ER+948GGA	VG1245ER+958BGA	VG1245ER+958BAA	
VG1245ES		46.8		VG1245ES+948AGA	VG1245ES+948GGA	VG1245ES+958BGA	VG1245ES+958BAA	
VG1245FR	2	29.2 ¹	200	VG1245FR+948AGA	VG1245FR+948GGA	VG1245FR+958BGA	VG1245FR+958BAA	
VG1245FS		46.8 ¹		VG1245FS+948AGA	VG1245FS+948GGA	VG1245FS+958BGA	VG1245FS+958BAA	
VG1245FT		73.7		VG1245FT+948AGA	VG1245FT+948GGA	VG1245FT+958BGA	VG1245FT+958BAA	

1. Valve has a characterizing disk.

Valve Assemblies with M9000-561 Thermal Barrier Installed — Rated for High-Temperature Fluid Service Two-Way — Spring Return Valve Open — Normally Open — Without End Switches (Part 1 of 2)

Fluid Temperatures: -22 to 284°F (-30 to 140°C) Water and 15 psi Steam				AC 24 V			AC 85–264 V (VA9203) AC 120 V (VA9208)	
Valve	Size, in.	Cv	Closeoff psig	Floating	DC 0 to 10 V Proportional	On/Off	On/Off	
Spring Return Open — Valve Normally Open								
				VA9203-AGA-2Z	VA9203-GGA-2Z	VA9203-BGA-2	VA9203-BUA-2	
VG1245AD	1/2	1.2 ¹	200	VG1245ADH923AGA	VG1245ADH923GGA	VG1245ADH923BGA	VG1245ADH923BUA	
VG1245AE		1.9 ¹		VG1245AEH923AGA	VG1245AEH923GGA	VG1245AEH923BGA	VG1245AEH923BUA	
VG1245AF		2.9 ¹		VG1245AFH923AGA	VG1245AFH923GGA	VG1245AFH923BGA	VG1245AFH923BUA	
VG1245AG		4.7 ¹		VG1245AGH923AGA	VG1245AGH923GGA	VG1245AGH923BGA	VG1245AGH923BUA	
VG1245AL		7.4 ¹		VG1245ALH923AGA	VG1245ALH923GGA	VG1245ALH923BGA	VG1245ALH923BUA	
VG1245AN		11.7		VG1245ANH923AGA	VG1245ANH923GGA	VG1245ANH923BGA	VG1245ANH923BUA	
VG1245BG	3/4	4.7 ¹	200	VG1245BGH923AGA	VG1245BGH923GGA	VG1245BGH923BGA	VG1245BGH923BUA	
VG1245BL		7.4 ¹		VG1245BLH923AGA	VG1245BLH923GGA	VG1245BLH923BGA	VG1245BLH923BUA	
VG1245BN		11.7		VG1245BNH923AGA	VG1245BNH923GGA	VG1245BNH923BGA	VG1245BNH923BUA	
VG1245CL	1	7.4 ¹	200	VG1245CLH923AGA	VG1245CLH923GGA	VG1245CLH923BGA	VG1245CLH923BUA	
VG1245CN		11.7 ¹		VG1245CNH923AGA	VG1245CNH923GGA	VG1245CNH923BGA	VG1245CNH923BUA	
VG1245CP		18.7		VG1245CPH923AGA	VG1245CPH923GGA	VG1245CPH923BGA	VG1245CPH923BUA	

VG1000 Series Two-Way, Stainless Steel Trim, NPT End Connections Ball Valves with Spring-Return Electric Actuators without Switches (Continued)

Valve Assemblies with M9000-561 Thermal Barrier Installed — Rated for High-Temperature Fluid Service Two-Way — Spring Return Valve Open — Normally Open — Without End Switches (Part 2 of 2)

Fluid Temperatures: -22 to 284°F (-30 to 140°C) Water and 15 psi Steam				AC 24 V			AC 85–264 V (VA9203) AC 120 V (VA9208)
Valve	Size, in.	Cv	Closeoff psig	Floating	DC 0 to 10 V Proportional	On/Off	On/Off
				Spring Return Open — Valve Normally Open			
				VA9208-AGA-2	VA9208-GGA-2	VA9208-BGA-3	VA9208-BAA-3
VG1245DN	1-1/4	11.7 ¹	200	VG1245DNH928AGA	VG1245DNH928GGA	VG1245DNH938BGA	VG1245DNH938BAA
VG1245DP		18.7 ¹		VG1245DPH928AGA	VG1245DPH928GGA	VG1245DPH938BGA	VG1245DPH938BAA
VG1245DR		29.2		VG1245DRH928AGA	VG1245DRH928GGA	VG1245DRH938BGA	VG1245DRH938BAA
VG1245EP	1-1/2	18.7 ¹	200	VG1245EPH928AGA	VG1245EPH928GGA	VG1245EPH938BGA	VG1245EPH938BAA
VG1245ER		29.2 ¹		VG1245ERH928AGA	VG1245ERH928GGA	VG1245ERH938BGA	VG1245ERH938BAA
VG1245ES		46.8		VG1245ESH928AGA	VG1245ESH928GGA	VG1245ESH938BGA	VG1245ESH938BAA
VG1245FR	2	29.2 ¹	200	VG1245FRH928AGA	VG1245FRH928GGA	VG1245FRH938BGA	VG1245FRH938BAA
VG1245FS		46.8 ¹		VG1245FSH928AGA	VG1245FSH928GGA	VG1245FSH938BGA	VG1245FSH938BAA
VG1245FT		73.7		VG1245FTH928AGA	VG1245FTH928GGA	VG1245FTH938BGA	VG1245FTH938BAA
				Spring Return Closed — Valve Normally Closed			
				VA9203-AGA-2Z	VA9203-GGA-2Z	VA9203-BGA-2	VA9203-BUA-2
VG1245AD	1/2	1.2	200	VG1245ADH943AGA	VG1245ADH943GGA	VG1245ADH943BGA	VG1245ADH943BUA
VG1245AE		1.9 ¹		VG1245AEH943AGA	VG1245AEH943GGA	VG1245AEH943BGA	VG1245AEH943BUA
VG1245AF		2.9 ¹		VG1245AFH943AGA	VG1245AFH943GGA	VG1245AFH943BGA	VG1245AFH943BUA
VG1245AG		4.7 ¹		VG1245AGH943AGA	VG1245AGH943GGA	VG1245AGH943BGA	VG1245AGH943BUA
VG1245AL		7.4 ¹		VG1245ALH943AGA	VG1245ALH943GGA	VG1245ALH943BGA	VG1245ALH943BUA
VG1245AN		11.7		VG1245ANH943AGA	VG1245ANH943GGA	VG1245ANH943BGA	VG1245ANH943BUA
VG1245BG	3/4	4.7 ¹	200	VG1245BGH943AGA	VG1245BGH943GGA	VG1245BGH943BGA	VG1245BGH943BUA
VG1245BL		7.4 ¹		VG1245BLH943AGA	VG1245BLH943GGA	VG1245BLH943BGA	VG1245BLH943BUA
VG1245BN		11.7		VG1245BNH943AGA	VG1245BNH943GGA	VG1245BNH943BGA	VG1245BNH943BUA
VG1245CL	1	7.4 ¹	200	VG1245CLH943AGA	VG1245CLH943GGA	VG1245CLH943BGA	VG1245CLH943BUA
VG1245CN		11.7 ¹		VG1245CNH943AGA	VG1245CNH943GGA	VG1245CNH943BGA	VG1245CNH943BUA
VG1245CP		18.7		VG1245CPH943AGA	VG1245CPH943GGA	VG1245CPH943BGA	VG1245CPH943BUA
				Spring Return Closed — Valve Normally Closed			
				VA9208-AGA-2	VA9208-GGA-2	VA9208-BGA-3	VA9208-BAA-3
VG1245DN	1-1/4	11.7 ¹	200	VG1245DNH948AGA	VG1245DNH948GGA	VG1245DNH958BGA	VG1245DNH958BAA
VG1245DP		18.7 ¹		VG1245DPH948AGA	VG1245DPH948GGA	VG1245DPH958BGA	VG1245DPH958BAA
VG1245DR		29.2		VG1245DRH948AGA	VG1245DRH948GGA	VG1245DRH958BGA	VG1245DRH958BAA
VG1245EP	1-1/2	18.7 ¹	200	VG1245EPH948AGA	VG1245EPH948GGA	VG1245EPH958BGA	VG1245EPH958BAA
VG1245ER		29.2 ¹		VG1245ERH948AGA	VG1245ERH948GGA	VG1245ERH958BGA	VG1245ERH958BAA
VG1245ES		46.8		VG1245ESH948AGA	VG1245ESH948GGA	VG1245ESH958BGA	VG1245ESH958BAA
VG1245FR	2	29.2 ¹	200	VG1245FRH948AGA	VG1245FRH948GGA	VG1245FRH958BGA	VG1245FRH958BAA
VG1245FS		46.8 ¹		VG1245FSH948AGA	VG1245FSH948GGA	VG1245FSH958BGA	VG1245FSH958BAA
VG1245FT		73.7		VG1245FTH948AGA	VG1245FTH948GGA	VG1245FTH958BGA	VG1245FTH958BAA

1. Valve has a characterizing disk.

VG1000 Series Two-Way, Stainless Steel Trim, NPT End Connections Ball Valves with Spring-Return Electric Actuators without Switches (Continued)

Technical Specifications

VG1000 Series Two-Way, Stainless Steel Trim, NPT End Connections Ball Valves with Spring-Return Electric Actuators without Switches		
Service ¹		Hot Water, Chilled Water, 50/50 Glycol Solutions, and 15 psig (103 kPa) Saturated Steam for HVAC Systems
Fluid Temperature Limits	Water	-22°F to 284°F (-30°C to 140°C)
	Steam	15 psig (103 kPa) at 250°F (121°C)
Maximum Actuator Fluid Temperature Limit	212°F (100°C)	VA9203 Series VA9208 Series
	284°F (140°C)	VA9203 Series with M9000-561 Thermal Barrier VA9208 Series with M9000-561 Thermal Barrier
Valve Body Pressure Rating	Water	580 psig (4,000 kPa) at 203°F (95°C) (PN40) 464 psig (3,196 kPa) at 284°F (140°C) (PN40)
	Steam	15 psig (103 kPa) Saturated Steam (Applies to VA9203 Series or VA9208 Series Actuators with M9000-561 Thermal Barrier Installed)
Maximum Closeoff Pressure		200 psid (1,378 kPa)
Maximum Recommended Operating Pressure Drop		50 psid (340 kPa)
Flow Characteristics	Two-Way	Equal Percentage
Rangeability ²		Greater than 500:1
Minimum Ambient Operating Temperature	-22°F (-30°C)	VA9203 Series Spring-Return Actuators
	-40°F (-40°C)	VA9208 Series Spring-Return Actuators
Maximum Ambient Operating Temperature ³ (Limited by the Actuator and Linkage)	Direct Mount	140°F (60°C): VA9203 or VA9208 Series Spring-Return Actuators
Leakage		0.01% of Maximum Flow per ANSI/FCI 70-2, Class 4
		1% of Maximum Flow for Three-Way Bypass Port
End Connections		National Pipe Thread (NPT)
Materials	Body	Forged Brass
	Ball	300 Series Stainless Steel
	Blowout-Proof Stem	300 Series Stainless Steel
	Seats	Graphite-Reinforced PTFE with Ethylene Propylene Diene Monomer (EPDM) O-Ring Backing
	Stem Seals	EPDM Double O-Rings
Characterizing Disk		Amodel® AS-1145HS Polyphthalamide Resin
Compliance CRN		0C16910.5C

1. Proper water treatment is recommended; refer to the VDI 2035 Guideline.
2. Rangeability is defined as the ratio of maximum controllable flow to minimum controllable flow.
3. In steam applications, install the valve with the stem horizontal to the piping and wrap the valve and piping with insulation.

WARNING: BRASS MAY CONTAIN LEAD

To fulfill our obligations towards Article 33, in accordance to the European REACH Regulation No 1907/2006 EC, we hereby inform you that this article contains the following Substances of Very High Concern mentioned on the Candidate list:

- Lead

VG1000 Series Two-Way, Plated Brass Trim, NPT End Connections Ball Valves with Non-Spring Return Electric Actuators

Description

VG1000 Series Ball Valves are designed to regulate the flow of hot or chilled water and, for some models, low-pressure steam in response to the demand of a controller in HVAC systems. Available in sizes 1/2 through 2 in. (DN15 through DN50), this family of two- and three-way forged brass valves is factory or field mounted to Johnson Controls® VA9104 and VA9300 Series Non-Spring Return and VA9203 and VA9208 Series Spring-Return Electric Actuators for on/off, floating, or proportional control.

Refer to the *VG1000 Series Forged Brass Ball Valves Product Bulletin (LIT-977132)* for important product application information.

Features

- Forged Brass Body — provides 580 psig static pressure rating.
- 200 psi Closeoff Pressure Rating — provides tight shutoff.

- Graphite-Reinforced Polytetrafluoroethylene (PTFE) Seats — include 15% graphite-reinforced ball seals, providing better wear resistance.
- Chrome-Plated Brass Ball and Stem Assembly Standard — handles both chilled and hot water applications with a fluid temperature range of 23°F to 203°F (-5°C to 95°C).
- 500:1 Rangeability — provides accurate control under all load conditions.



VG1000 Series Two-Way Non-Spring Return Plated Brass Ball and Stem Ball Valve Assemblies

Repair Information

If the VG1000 Series Ball Valve fails to operate within its specifications, replace the valve body, actuator, or entire assembly. For replacement parts, contact the nearest Johnson Controls representative.



This product is made of copper alloy, which contains lead. The product is therefore not to be used on drinking water.



This product can expose you to chemicals including lead, which is known to the State of California to cause cancer, birth defects, or other reproductive harm. For more information, go to www.P65Warnings.ca.gov.

Selection Charts

Two-Way Plated Brass Trim Valves, Non-Spring Return, VA9104 Series Electric Actuators without Switches

Fluid Temperatures: 23°F to 203°F (-5°C to 95°C) Not Rated for Steam Service				AC 24 V		
Valve	Size, in.	Cv	Closeoff psig	On/Off and/or Floating without Timeout ¹	On/Off and/or Floating with Timeout	DC 0 to 10 V Proportional
Actuators with M3 Screw Terminals				VA9104-AGA-3S	VA9104-IGA-3S	VA9104-GGA-3S
VG1241AD	1/2	1.2 ²	200	VG1241AD+9T4AGA	VG1241AD+9T4IGA	VG1241AD+9T4GGA
VG1241AE		1.9 ²		VG1241AE+9T4AGA	VG1241AE+9T4IGA	VG1241AE+9T4GGA
VG1241AF		2.9 ²		VG1241AF+9T4AGA	VG1241AF+9T4IGA	VG1241AF+9T4GGA
VG1241AG		4.7 ²		VG1241AG+9T4AGA	VG1241AG+9T4IGA	VG1241AG+9T4GGA
VG1241AL		7.4 ²		VG1241AL+9T4AGA	VG1241AL+9T4IGA	VG1241AL+9T4GGA
VG1241AN		11.7		VG1241AN+9T4AGA	VG1241AN+9T4IGA	VG1241AN+9T4GGA
VG1241BG	3/4	4.7 ²	200	VG1241BG+9T4AGA	VG1241BG+9T4IGA	VG1241BG+9T4GGA
VG1241BL		7.4 ²		VG1241BL+9T4AGA	VG1241BL+9T4IGA	VG1241BL+9T4GGA
VG1241BN		11.7		VG1241BN+9T4AGA	VG1241BN+9T4IGA	VG1241BN+9T4GGA
VG1241CL	1	7.4 ²	200	VG1241CL+9T4AGA	VG1241CL+9T4IGA	VG1241CL+9T4GGA
VG1241CN		11.7 ²		VG1241CN+9T4AGA	VG1241CN+9T4IGA	VG1241CN+9T4GGA
VG1241CP		18.7		VG1241CP+9T4AGA	VG1241CP+9T4IGA	VG1241CP+9T4GGA
Actuators with 120 in. (3.05 m) 18 AWG Plenum Cable				VA9104-AGA-2S	VA9104-IGA-2S	VA9104-GGA-2S
VG1241AD	1/2	1.2 ²	200	VG1241AD+9A4AGA	VG1241AD+9A4IGA	VG1241AD+9A4GGA
VG1241AE		1.9 ²		VG1241AE+9A4AGA	VG1241AE+9A4IGA	VG1241AE+9A4GGA
VG1241AF		2.9 ²		VG1241AF+9A4AGA	VG1241AF+9A4IGA	VG1241AF+9A4GGA
VG1241AG		4.7 ²		VG1241AG+9A4AGA	VG1241AG+9A4IGA	VG1241AG+9A4GGA
VG1241AL		7.4 ²		VG1241AL+9A4AGA	VG1241AL+9A4IGA	VG1241AL+9A4GGA
VG1241AN		11.7		VG1241AN+9A4AGA	VG1241AN+9A4IGA	VG1241AN+9A4GGA
VG1241BG	3/4	4.7 ²	200	VG1241BG+9A4AGA	VG1241BG+9A4IGA	VG1241BG+9A4GGA
VG1241BL		7.4 ²		VG1241BL+9A4AGA	VG1241BL+9A4IGA	VG1241BL+9A4GGA
VG1241BN		11.7		VG1241BN+9A4AGA	VG1241BN+9A4IGA	VG1241BN+9A4GGA
VG1241CL	1	7.4 ²	200	VG1241CL+9A4AGA	VG1241CL+9A4IGA	VG1241CL+9A4GGA
VG1241CN		11.7 ²		VG1241CN+9A4AGA	VG1241CN+9A4IGA	VG1241CN+9A4GGA
VG1241CP		18.7		VG1241CP+9A4AGA	VG1241CP+9A4IGA	VG1241CP+9A4GGA

1. To avoid excessive wear or drive time on the motor for the AGA models, use a controller or software that provides a timeout function to remove the signal at the end of rotation (stall).
2. Valve has a characterizing disk.

VG1000 Series Two-Way, Plated Brass Trim, NPT End Connections Ball Valves with Non-Spring Return Electric Actuators (Continued)

Two-Way Plated Brass Trim Ball Valves, Non-Spring Return, VA9300 Series Electric Actuators For Fluid Temperatures to 203°F

Fluid Temperature: 23°F to 203°F (-5°C to 95°C) Not Rated for Steam Service				AC/DC 24 V		
				On/Off with Timeout	Floating with Timeout	DC 0(2) to 10 V Proportional
Valve	Size, in.	Cv	Closeoff psi	Actuators without Switches		
				VA9310-HGA-2		
VG1241DN	1-1/4	11.7 ¹	200	VG1241DN+910HGA		
VG1241DP		18.7 ¹		VG1241DP+910HGA		
VG1241DR		29.2		VG1241DR+910HGA		
VG1241EP	1-1/2	18.7 ¹	200	VG1241EP+910HGA		
VG1241ER		29.2 ¹		VG1241ER+910HGA		
VG1241ES		46.8		VG1241ES+910HGA		
VG1241FR	2	29.2 ¹	200	VG1241FR+910HGA		
VG1241FS		46.8 ¹		VG1241FS+910HGA		
VG1241FT		73.7		VG1241FT+910HGA		
Valve	Size, in.	Cv	Closeoff psi	Actuators With Two Switches		
				VA9300 actuator with M9300-2 Switch Kit²		
VG1241AD	1/2	1.2 ¹	200	VG1241AD+910HGC		
VG1241AE		1.9 ¹		VG1241AE+910HGC		
VG1241AF		2.9 ¹		VG1241AF+910HGC		
VG1241AG		4.7 ¹		VG1241AG+910HGC		
VG1241AL		7.4 ¹		VG1241AL+910HGC		
VG1241AN		11.7		VG1241AN+910HGC		
VG1241BG	3/4	4.7 ¹	200	VG1241BG+910HGC		
VG1241BL		7.4 ¹		VG1241BL+910HGC		
VG1241BN		11.7		VG1241BN+910HGC		
VG1241CL	1	7.4 ¹	200	VG1241CL+910HGC		
VG1241CN		11.7 ¹		VG1241CN+910HGC		
VG1241CP		18.7		VG1241CP+910HGC		
VG1241DN	1-1/4	11.7 ¹	200	VG1241DN+910HGC		
VG1241DP		18.7 ¹		VG1241DP+910HGC		
VG1241DR		29.2		VG1241DR+910HGC		
VG1241EP	1-1/2	18.7 ¹	200	VG1241EP+910HGC		
VG1241ER		29.2 ¹		VG1241ER+910HGC		
VG1241ES		46.8		VG1241ES+910HGC		
VG1241FR	2	29.2 ¹	200	VG1241FR+910HGC		
VG1241FS		46.8 ¹		VG1241FS+910HGC		
VG1241FT		73.7		VG1241FT+910HGC		

1. Valve has a characterizing disk.
2. For field mounting order VA9310-HGA-2 and the M9300-2 Switch Kit separately.

VG1000 Series Two-Way, Plated Brass Trim, NPT End Connections Ball Valves with Non-Spring Return Electric Actuators (Continued)

Technical Specifications

VG1000 Series Two-Way, Plated Brass Trim, NPT End Connections Ball Valves with Non-Spring Return Electric Actuators		
Service ¹		Hot Water, Chilled Water, or 50/50 Glycol Solutions for HVAC Systems
Valve Fluid Temperature Limits	Water	23°F to 203°F (-5°C to 95°C)
	Steam	Not Rated for Steam Service
Maximum Fluid Temperature Limit	203°F (95°C)	VA9104 Series Non-Spring Return Actuators VA9300 Series Non-Spring Return Actuators
Valve Body Pressure Rating	Water	580 psig (4,000 kPa) at 203°F (95°C) (PN40)
	Steam	Not Rated for Steam Service
Maximum Closeoff Pressure		200 psid (1,378 kPa)
Maximum Recommended Operating Pressure Drop		50 psid (340 kPa)
Flow Characteristics	Two-Way	Equal Percentage
Rangeability ²		Greater than 500:1
Minimum Ambient Operating Temperature	-4°F (-20°C)	VA9104 Series Non-Spring Return Actuators
	-22°F (-30°C)	VA9300 Series Non-Spring Return Actuators
Maximum Ambient Operating Temperature	140°F (60°C)	VA9104 Series Non-Spring Return Actuators VA9300 Series Non-Spring Return Actuators
Leakage		0.01% of Maximum Flow per ANSI/FCI 70-2, Class 4
End Connections		National Pipe Thread (NPT)
Materials	Body	Forged Brass
	Ball	Chrome Plated Brass
	Blowout-Proof Stem	Nickel Plated Brass
	Seats	Graphite-Reinforced PTFE with Ethylene Propylene Diene Monomer (EPDM) O-Ring Backing
	Stem Seals	EPDM Double O-Rings
	Characterizing Disk	Amodel® AS-1145HS Polyphthalamide Resin

1. Proper water treatment is recommended; refer to the VDI 2035 Guideline.
2. Rangeability is defined as the ratio of maximum controllable flow to minimum controllable flow.

WARNING: BRASS MAY CONTAIN LEAD

To fulfill our obligations towards Article 33, in accordance to the European REACH Regulation No 1907/2006 EC, we hereby inform you that this article contains the following Substances of Very High Concern mentioned on the Candidate list:

- Lead

VG1000 Series Three-Way, Plated Brass Trim, NPT End Connections Ball Valves with Non-Spring Return Electric Actuators

Description

VG1000 Series Ball Valves are designed to regulate the flow of hot or chilled water and, for some models, low-pressure steam in response to the demand of a controller in HVAC systems. Available in sizes 1/2 through 2 in. (DN15 through DN50), this family of two- and three-way forged brass valves is factory or field mounted to Johnson Controls® VA9104 and VA9300 Series Non-Spring Return and VA9203 and VA9208 Series Spring-Return Electric Actuators for on/off, floating, or proportional control.

Refer to the *VG1000 Series Forged Brass Ball Valves Product Bulletin (LIT-977132)* for important product application information.

Features

- Forged Brass Body — provides 580 psig static pressure rating.
- 200 psi Closeoff Pressure Rating — provides tight shutoff.

- Graphite-Reinforced Polytetrafluoroethylene (PTFE) Seats — include 15% graphite-reinforced ball seals, providing better wear resistance.
- 500:1 Rangeability — provides accurate control under all load conditions.
- Chrome-Plated Brass Ball and Stem Assembly Standard — handles both chilled and hot water applications with a fluid temperature range of 23°F to 203°F (-5°C to 95°C).

Repair Information

If the VG1000 Series Ball Valve fails to operate within its specifications, replace the valve body, actuator, or entire assembly. For replacement parts, contact the nearest Johnson Controls representative.



VG1000 Series Three-Way, Non-Spring Return, Plated Brass Ball and Stem Ball Valve Assemblies without End Switches

Selection Charts

Three-Way Plated Brass Trim Ball Valves, Non-Spring Return, VA9104 Series Electric Actuators without Switches

Fluid Temperatures: 23°F to 203°F (-5°C to 95°C) Not Rated for Steam Service				AC 24 V		
Valve	Size, in.	Cv	Closeoff psig	On/Off (Floating) without Timeout ¹	On/Off (Floating) with Timeout	DC 0 to 10 V Proportional
Actuators with M3 Screw Terminals				VA9104-AGA-3S	VA9104-IGA-3S	VA9104-GGA-3S
VG1841AD	1/2	1.2/0.7 ²	200	VG1841AD+9T4AGA	VG1841AD+9T4IGA	VG1841AD+9T4GGA
VG1841AE		1.9/1.2 ²		VG1841AE+9T4AGA	VG1841AE+9T4IGA	VG1841AE+9T4GGA
VG1841AF		2.9/1.9 ²		VG1841AF+9T4AGA	VG1841AF+9T4IGA	VG1841AF+9T4GGA
VG1841AG		4.7/2.9 ²		VG1841AG+9T4AGA	VG1841AG+9T4IGA	VG1841AG+9T4GGA
VG1841AL		7.4/4.7 ²		VG1841AL+9T4AGA	VG1841AL+9T4IGA	VG1841AL+9T4GGA
VG1841AN		11.7/5.8		VG1841AN+9T4AGA	VG1841AN+9T4IGA	VG1841AN+9T4GGA
VG1841BG	3/4	4.7/2.9 ²	200	VG1841BG+9T4AGA	VG1841BG+9T4IGA	VG1841BG+9T4GGA
VG1841BL		7.4/4.7 ²		VG1841BL+9T4AGA	VG1841BL+9T4IGA	VG1841BL+9T4GGA
VG1841BN		11.7/5.8		VG1841BN+9T4AGA	VG1841BN+9T4IGA	VG1841BN+9T4GGA
VG1841CL	1	7.4/4.7 ²	200	VG1841CL+9T4AGA	VG1841CL+9T4IGA	VG1841CL+9T4GGA
VG1841CN		11.7/7.4 ²		VG1841CN+9T4AGA	VG1841CN+9T4IGA	VG1841CN+9T4GGA
VG1841CP		18.7/9.4		VG1841CP+9T4AGA	VG1841CP+9T4IGA	VG1841CP+9T4GGA
Actuators with 120 in. (3.05 m) 18 AWG Plenum Cable				VA9104-AGA-2S	VA9104-IGA-2S	VA9104-GGA-2S
VG1841AD	1/2	1.2/0.7 ²	200	VG1841AD+9A4AGA	VG1841AD+9A4IGA	VG1841AD+9A4GGA
VG1841AE		1.9/1.2 ²		VG1841AE+9A4AGA	VG1841AE+9A4IGA	VG1841AE+9A4GGA
VG1841AF		2.9/1.9 ²		VG1841AF+9A4AGA	VG1841AF+9A4IGA	VG1841AF+9A4GGA
VG1841AG		4.7/2.9 ²		VG1841AG+9A4AGA	VG1841AG+9A4IGA	VG1841AG+9A4GGA
VG1841AL		7.4/4.7 ²		VG1841AL+9A4AGA	VG1841AL+9A4IGA	VG1841AL+9A4GGA
VG1841AN		11.7/5.8		VG1841AN+9A4AGA	VG1841AN+9A4IGA	VG1841AN+9A4GGA
VG1841BG	3/4	4.7/2.9 ²	200	VG1841BG+9A4AGA	VG1841BG+9A4IGA	VG1841BG+9A4GGA
VG1841BL		7.4/4.7 ²		VG1841BL+9A4AGA	VG1841BL+9A4IGA	VG1841BL+9A4GGA
VG1841BN		11.7/5.8		VG1841BN+9A4AGA	VG1841BN+9A4IGA	VG1841BN+9A4GGA
VG1841CL	1	7.4/4.7 ²	200	VG1841CL+9A4AGA	VG1841CL+9A4IGA	VG1841CL+9A4GGA
VG1841CN		11.7/7.4 ²		VG1841CN+9A4AGA	VG1841CN+9A4IGA	VG1841CN+9A4GGA
VG1841CP		18.7/9.4		VG1841CP+9A4AGA	VG1841CP+9A4IGA	VG1841CP+9A4GGA

1. To avoid excessive wear or drive time on the motor for the AGA models, use a controller or software that provides a timeout function to remove the signal at the end of rotation (stall).
2. Valve has a characterizing disk.

VG1000 Series Three-Way, Plated Brass Trim, NPT End Connections Ball Valves with Non-Spring Return Electric Actuators (Continued)

Three-Way Plated Brass Trim Ball Valves, Non-Spring Return, VA9300 Series Electric Actuators without Switches

Fluid Temperature: 23°F to 203°F (-5°C to 95°C) Not Rated for Steam Service				AC/DC 24 V		
				On/Off	Floating	DC 0(2) to 10 V Proportional
Valve	Size, in.	Cv	Closeoff psi	VA9310-HGA-2		
VG1841DN	1-1/4	11.7 ¹	200	VG1841DN+910HGA		
VG1841DP		18.7 ¹		VG1841DP+910HGA		
VG1841DR		29.2		VG1841DR+910HGA		
VG1841EP	1-1/2	18.7 ¹	200	VG1841EP+910HGA		
VG1841ER		29.2 ¹		VG1841ER+910HGA		
VG1841ES		46.8		VG1841ES+910HGA		
VG1841FR	2	29.2 ¹	200	VG1841FR+910HGA		
VG1841FS		46.8 ¹		VG1841FS+910HGA		
VG1841FT		73.7		VG1841FT+910HGA		

1. Valve has a characterizing disk.

Three-Way Plated Brass Trim Ball Valves, Non-Spring Return, VA9300 Series Electric Actuators with Switches

Fluid Temperature: 23°F to 203°F (-5°C to 95°C) Not Rated for Steam Service				AC/DC 24 V		
				On/Off	Floating	DC 0(2) to 10 V Proportional
Valve	Size, in.	Cv	Closeoff psi	VA9310 actuator with M9000-2 Switch Kit ¹		
VG1841AD	1/2	1.2 ²	200	VG1841AD+910HGC		
VG1841AE		1.9 ²		VG1841AE+910HGC		
VG1841AF		2.9 ²		VG1841AF+910HGC		
VG1841AG		4.7 ²		VG1841AG+910HGC		
VG1841AL		7.4 ²		VG1841AL+910HGC		
VG1841AN		11.7		VG1841AN+910HGC		
VG1841BG	3/4	4.7 ²	200	VG1841BG+910HGC		
VG1841BL		7.4 ²		VG1841BL+910HGC		
VG1841BN		11.7		VG1841BN+910HGC		
VG1841CL	1	7.4 ²	200	VG1841CL+910HGC		
VG1841CN		11.7 ²		VG1841CN+910HGC		
VG1841CP		18.7		VG1841CP+910HGC		
VG1841DN	1-1/4	11.7 ²	200	VG1841DN+910HGC		
VG1841DP		18.7 ²		VG1841DP+910HGC		
VG1841DR		29.2		VG1841DR+910HGC		
VG1841EP	1-1/2	18.7 ²	200	VG1841EP+910HGC		
VG1841ER		29.2 ²		VG1841ER+910HGC		
VG1841ES		46.8		VG1841ES+910HGC		
VG1841FR	2	29.2 ²	200	VG1841FR+910HGC		
VG1841FS		46.8 ²		VG1841FS+910HGC		
VG1841FT		73.7		VG1841FT+910HGC		

1. For field mounting order VA9310-HGA-2 and the M9300-2 Switch Kit separately

2. Valve has a characterizing disk.

VG1000 Series Three-Way, Plated Brass Trim, NPT End Connections Ball Valves with Non-Spring Return Electric Actuators (Continued)

Technical Specifications

VG1000 Series Three-Way, Plated Brass Trim, NPT End Connections Ball Valves with Non-Spring Return Electric Actuators		
Service¹		Hot Water, Chilled Water, and 50/50 Glycol Solutions for HVAC Systems
Valve Fluid Temperature Limits	Water	23°F to 203°F (-5°C to 95°C)
	Steam	Not Rated for Steam Service
Maximum Fluid Temperature Limit	203°F (95°C)	VA9104 Series Actuators VA9300 Series Actuator
Valve Body Pressure Rating	Water	580 psig (4,000 kPa) at 203°F (95°C) (PN40)
	Steam	Not Rated for Steam Service
Maximum Closeoff Pressure		200 psig (1,378 kPa)
Maximum Recommended Operating Pressure Drop		50 psig (340 kPa)
Flow Characteristics	Three-Way	Equal Percentage Flow Characteristics of In-Line Port A (Coil) and Linear Flow Characteristics of Angle Port B (Bypass)
Rangeability²		Greater than 500:1
Minimum Ambient Operating Temperature	-4°F (-20°C)	VA9104 Series Non-Spring Return Actuators
	-22°F (-30°C)	VA9300 Series Non-Spring Return Actuators
Maximum Ambient Operating Temperature	140°F (60°C)	VA9104 Series Non-Spring Return Actuators VA9300 Series Non-Spring Return Actuators
Leakage		0.01% of Maximum Flow per ANSI/FCI 70-2, Class 4
End Connections		National Pipe Thread (NPT)
Materials	Body	Forged Brass
	Ball	Chrome Plated Brass
	Blowout-Proof Stem	Nickel Plated Brass
	Seats	Graphite-Reinforced PTFE with Ethylene Propylene Diene Monomer (EPDM) O-Ring Backing
	Stem Seals	EPDM Double O-Rings
	Characterizing Disk	Amodel® AS-1145HS Polyphthalamide Resin

1. Proper water treatment is recommended; refer to the VDI 2035 Guideline.
2. Rangeability is defined as the ratio of maximum controllable flow to minimum controllable flow.



WARNING This product is made of copper alloy, which contains lead. The product is therefore not to be used on drinking water.



WARNING This product can expose you to chemicals including lead, which is known to the State of California to cause cancer, birth defects, or other reproductive harm. For more information, go to www.P65Warnings.ca.gov.

WARNING: BRASS MAY CONTAIN LEAD

To fulfill our obligations towards Article 33, in accordance to the European REACH Regulation No 1907/2006 EC, we hereby inform you that this article contains the following Substances of Very High Concern mentioned on the Candidate list:

- Lead

VG1000 Series Two-Way, Plated Brass Trim, NPT End Connections Ball Valves with Spring-Return Electric Actuators without Switches

Description

VG1000 Series Ball Valves are designed to regulate the flow of hot or chilled water and, for some models, low-pressure steam in response to the demand of a controller in HVAC systems. Available in sizes 1/2 through 2 in. (DN15 through DN50), this family of two- and three-way forged brass valves is factory or field mounted to Johnson Controls® VA9104, M9106, M9109, and M9100 Series Non-Spring-Return and VA9203 and VA9208 Series Spring-Return Electric Actuators for on/off, floating, or proportional control.

Refer to the *VG1000 Series Forged Brass Ball Valves Product Bulletin (LIT-977132)* for important product application information.

Features

- Forged Brass Body — provides 580 psig static pressure rating.
- Chrome-Plated Brass Ball and Stem Assembly Standard — handles both chilled water and hot water applications with a fluid temperature range of 23°F to 203°F (-5°C to 95°C).
- Graphite-Reinforced Polytetrafluoroethylene (PTFE) Seats — include 15% graphite-reinforced ball seals, providing better wear resistance.
- 500:1 Rangeability — provides accurate control under all load conditions.
- Maintenance-Free Design — performs without failure in excess of 200,000 full stroke cycles in iron-oxide contaminated water.



Repair Information

If the VG1000 Series Ball Valve fails to operate within its specifications, replace the valve body, actuator, or entire assembly. For replacement parts, contact the nearest Johnson Controls representative.

VG1000 Series Two-Way, Spring-Return, Plated Brass Ball and Stem Ball Valve Assemblies without End Switches

Selection Chart

Two-Way — Spring Return without Switches (Part 1 of 2)

Fluid Temperatures: 23°F to 203°F (-5°C to 95°C)				AC 24 V			AC 85–264 V (VA9203) AC 120 V (VA9208)
Valve	Size, in.	Cv	Closeoff psig	Floating	DC 0 to 10 V Proportional	On/Off	On/Off
				Spring Return Open — Valve Normally Open			
				VA9203-AGA-2Z	VA9203-GGA-2Z	VA9203-BGA-2	VA9203-BUA-2
VG1241AD	1/2	1.2 ¹	200	VG1241AD+923AGA	VG1241AD+923GGA	VG1241AD+923BGA	VG1241AD+923BUA
VG1241AE		1.9 ¹		VG1241AE+923AGA	VG1241AE+923GGA	VG1241AE+923BGA	VG1241AE+923BUA
VG1241AF		2.9 ¹		VG1241AF+923AGA	VG1241AF+923GGA	VG1241AF+923BGA	VG1241AF+923BUA
VG1241AG		4.7 ¹		VG1241AG+923AGA	VG1241AG+923GGA	VG1241AG+923BGA	VG1241AG+923BUA
VG1241AL		7.4 ¹		VG1241AL+923AGA	VG1241AL+923GGA	VG1241AL+923BGA	VG1241AL+923BUA
VG1241AN		11.7		VG1241AN+923AGA	VG1241AN+923GGA	VG1241AN+923BGA	VG1241AN+923BUA
VG1241BG	3/4	4.7 ¹	200	VG1241BG+923AGA	VG1241BG+923GGA	VG1241BG+923BGA	VG1241BG+923BUA
VG1241BL		7.4 ¹		VG1241BL+923AGA	VG1241BL+923GGA	VG1241BL+923BGA	VG1241BL+923BUA
VG1241BN		11.7		VG1241BN+923AGA	VG1241BN+923GGA	VG1241BN+923BGA	VG1241BN+923BUA
VG1241CL	1	7.4 ¹	200	VG1241CL+923AGA	VG1241CL+923GGA	VG1241CL+923BGA	VG1241CL+923BUA
VG1241CN		11.7 ¹		VG1241CN+923AGA	VG1241CN+923GGA	VG1241CN+923BGA	VG1241CN+923BUA
VG1241CP		18.7		VG1241CP+923AGA	VG1241CP+923GGA	VG1241CP+923BGA	VG1241CP+923BUA
				Spring Return Open — Valve Normally Open			
				VA9208-AGA-2	VA9208-GGA-2	VA9208-BGA-3	VA9208-BAA-3
VG1241DN	1-1/4	11.7 ¹	200	VG1241DN+928AGA	VG1241DN+928GGA	VG1241DN+938BGA	VG1241DN+938BAA
VG1241DP		18.7 ¹		VG1241DP+928AGA	VG1241DP+928GGA	VG1241DP+938BGA	VG1241DP+938BAA
VG1241DR		29.2		VG1241DR+928AGA	VG1241DR+928GGA	VG1241DR+938BGA	VG1241DR+938BAA
VG1241EP	1-1/2	18.7 ¹	200	VG1241EP+928AGA	VG1241EP+928GGA	VG1241EP+938BGA	VG1241EP+938BAA
VG1241ER		29.2 ¹		VG1241ER+928AGA	VG1241ER+928GGA	VG1241ER+938BGA	VG1241ER+938BAA
VG1241ES		46.8		VG1241ES+928AGA	VG1241ES+928GGA	VG1241ES+938BGA	VG1241ES+938BAA
VG1241FR	2	29.2 ¹	200	VG1241FR+928AGA	VG1241FR+928GGA	VG1241FR+938BGA	VG1241FR+938BAA
VG1241FS		46.8 ¹		VG1241FS+928AGA	VG1241FS+928GGA	VG1241FS+938BGA	VG1241FS+938BAA
VG1241FT		73.7		VG1241FT+928AGA	VG1241FT+928GGA	VG1241FT+938BGA	VG1241FT+938BAA

The performance specifications are nominal and conform to acceptable industry standards. For applications at conditions beyond these specifications, consult the local Johnson Controls office. Johnson Controls shall not be liable for damages resulting from misapplication or misuse of its products. © 2019 Johnson Controls. www.johnsoncontrols.com

VG1000 Series Two-Way, Plated Brass Trim, NPT End Connections Ball Valves with Spring-Return Electric Actuators without Switches (Continued)

Two-Way — Spring Return without Switches (Part 2 of 2)

Fluid Temperatures: 23°F to 203°F (-5°C to 95°C)				AC 24 V			AC 85–264 V (VA9203) AC 120 V (VA9208)
Valve	Size, in.	Cv	Closeoff psig	Floating	DC 0 to 10 V Proportional	On/Off	On/Off
				Spring Return Closed — Valve Normally Closed			
				VA9203-AGA-2Z	VA9203-GGA-2Z	VA9203-BGA-2	VA9203-BUA-2
VG1241AD	1/2	1.2 ¹	200	VG1241AD+943AGA	VG1241AD+943GGA	VG1241AD+943BGA	VG1241AD+943BUA
VG1241AE		1.9 ¹		VG1241AE+943AGA	VG1241AE+943GGA	VG1241AE+943BGA	VG1241AE+943BUA
VG1241AF		2.9 ¹		VG1241AF+943AGA	VG1241AF+943GGA	VG1241AF+943BGA	VG1241AF+943BUA
VG1241AG		4.7 ¹		VG1241AG+943AGA	VG1241AG+943GGA	VG1241AG+943BGA	VG1241AG+943BUA
VG1241AL		7.4 ¹		VG1241AL+943AGA	VG1241AL+943GGA	VG1241AL+943BGA	VG1241AL+943BUA
VG1241AN		11.7		VG1241AN+943AGA	VG1241AN+943GGA	VG1241AN+943BGA	VG1241AN+943BUA
VG1241BG	3/4	4.7 ¹	200	VG1241BG+943AGA	VG1241BG+943GGA	VG1241BG+943BGA	VG1241BG+943BUA
VG1241BL		7.4 ¹		VG1241BL+943AGA	VG1241BL+943GGA	VG1241BL+943BGA	VG1241BL+943BUA
VG1241BN		11.7		VG1241BN+943AGA	VG1241BN+943GGA	VG1241BN+943BGA	VG1241BN+943BUA
VG1241CL	1	7.4 ¹	200	VG1241CL+943AGA	VG1241CL+943GGA	VG1241CL+943BGA	VG1241CL+943BUA
VG1241CN		11.7 ¹		VG1241CN+943AGA	VG1241CN+943GGA	VG1241CN+943BGA	VG1241CN+943BUA
VG1241CP		18.7		VG1241CP+943AGA	VG1241CP+943GGA	VG1241CP+943BGA	VG1241CP+943BUA
				Spring Return Closed — Valve Normally Closed			
				VA9208-AGA-2	VA9208-GGA-2	VA9208-BGA-3	VA9208-BAA-3
VG1241DN	1-1/4	11.7 ¹	200	VG1241DN+948AGA	VG1241DN+948GGA	VG1241DN+958BGA	VG1241DN+958BAA
VG1241DP		18.7 ¹		VG1241DP+948AGA	VG1241DP+948GGA	VG1241DP+958BGA	VG1241DP+958BAA
VG1241DR		29.2		VG1241DR+948AGA	VG1241DR+948GGA	VG1241DR+958BGA	VG1241DR+958BAA
VG1241EP	1-1/2	18.7 ¹	200	VG1241EP+948AGA	VG1241EP+948GGA	VG1241EP+958BGA	VG1241EP+958BAA
VG1241ER		29.2 ¹		VG1241ER+948AGA	VG1241ER+948GGA	VG1241ER+958BGA	VG1241ER+958BAA
VG1241ES		46.8		VG1241ES+948AGA	VG1241ES+948GGA	VG1241ES+958BGA	VG1241ES+958BAA
VG1241FR	2	29.2 ¹	200	VG1241FR+948AGA	VG1241FR+948GGA	VG1241FR+958BGA	VG1241FR+958BAA
VG1241FS		46.8 ¹		VG1241FS+948AGA	VG1241FS+948GGA	VG1241FS+958BGA	VG1241FS+958BAA
VG1241FT		73.7		VG1241FT+948AGA	VG1241FT+948GGA	VG1241FT+958BGA	VG1241FT+958BAA

1. Valve has a characterizing disk.

VG1000 Series Two-Way, Plated Brass Trim, NPT End Connections Ball Valves with Spring-Return Electric Actuators without Switches (Continued)

Technical Specifications

VG1000 Series Two-Way, Plated Brass Trim, NPT End Connections Ball Valves with Spring-Return Electric Actuators without Switches		
Service ¹		Hot Water, Chilled Water, 50/50 Glycol Solutions
Fluid Temperature Limits	Water	23°F to 203°F (-5°C to 95°C)
	Steam	Not Rated for Steam Service
Valve Body Pressure Rating	Water	580 psig (4,000 kPa) (PN40)
	Steam	Not Rated for Steam Service
Maximum Closeoff Pressure		200 psid (1,378 kPa)
Maximum Recommended Operating Pressure Drop		50 psid (340 kPa)
Flow Characteristics	Two-Way	Equal Percentage
Rangeability ²		Greater than 500:1
Minimum Ambient Operating Temperature	-22°F (-30°C)	VA9203 Series Spring-Return Actuators
	-40°F (-40°C)	VA9208 Series Spring-Return Actuators
Maximum Ambient Operating Temperature ³ (Limited by the Actuator)	140°F (60°C)	VA9203 or VA9208 Series Spring-Return Actuators
Leakage		0.01% of Maximum Flow per ANSI/FCI 70-2, Class 4
End Connections		National Pipe Thread (NPT)
Materials	Body	Forged Brass
	Ball	Chrome Plated Brass
	Blowout-Proof Stem	Nickel Plated Brass
	Seats	Graphite-Reinforced PTFE with Ethylene Propylene Diene Monomer (EPDM) O-Ring Backing
	Stem Seals	EPDM Double O-Rings
	Characterizing Disk	Amodel® AS-1145HS Polyphthalamide Resin

1. Proper water treatment is recommended; refer to the VDI 2035 Guideline.
2. Rangeability is defined as the ratio of maximum controllable flow to minimum controllable flow.
3. In steam applications, install the valve with the stem horizontal to the piping and wrap the valve and piping with insulation.



WARNING This product is made of copper alloy, which contains lead. The product is therefore not to be used on drinking water.



WARNING This product can expose you to chemicals including lead, which is known to the State of California to cause cancer, birth defects, or other reproductive harm. For more information, go to www.P65Warnings.ca.gov.

WARNING: BRASS MAY CONTAIN LEAD

To fulfill our obligations towards Article 33, in accordance to the European REACH Regulation No 1907/2006 EC, we hereby inform you that this article contains the following Substances of Very High Concern mentioned on the Candidate list:

- Lead

VG1000 Series Two-Way, Plated Brass Trim, NPT End Connections Ball Valves with Spring-Return Electric Actuators with Switches

Description

VG1000 Series Ball Valves are designed to regulate the flow of hot or chilled water and, for some models, low-pressure steam in response to the demand of a controller in HVAC systems. Available in sizes 1/2 through 2 in. (DN15 through DN50), this family of two- and three-way forged brass valves is factory or field mounted to Johnson Controls® VA9104, M9106, M9109, and M9100 Series Non-Spring-Return and VA9203 and VA9208 Series Spring-Return Electric Actuators for on/off, floating, or proportional control.

Refer to the *VG1000 Series Forged Brass Ball Valves Product Bulletin (LIT-977132)* for important product application information and single point of contact information.

Features

- Forged Brass Body — provides 580 psig static pressure rating.
- Graphite-Reinforced Polytetrafluoroethylene (PTFE) Seats — include 15% graphite-reinforced ball seals, providing better wear resistance.
- 500:1 Rangeability — provides accurate control under all load conditions.
- Maintenance-Free Design — performs without failure in excess of 200,000 full stroke cycles in iron-oxide contaminated water.

VG1000 Series Two-Way, Spring-Return, Plated Brass Ball and Stem Ball Valve Assemblies with End Switches



Repair Information

If the VG1000 Series Ball Valve fails to operate within its specifications, replace the valve body, actuator, or entire assembly. For replacement parts, contact the nearest Johnson Controls representative.

Selection Charts

Two-Way — Spring Return Valve Open — Normally Open with Switches

Fluid Temperatures: 23°F to 203°F (-5°C to 95°C)				AC 24 V			AC 85–264 V (VA9203) AC 120 V (VA9208)
Valve	Size, in.	Cv	Closeoff psig	Floating	DC 0 to 10 V Proportional	On/Off	On/Off
				Spring Return Open — Valve Normally Open — Actuators with One Switch			
				VA9203-AGB-2Z	VA9203-GGB-2Z	VA9203-BGB-2	VA9203-BUB-2
VG1241AD	1/2	1.2 ¹	200	VG1241AD+923AGB	VG1241AD+923GGB	VG1241AD+923BGB	VG1241AD+923BUB
VG1241AE		1.9 ¹		VG1241AE+923AGB	VG1241AE+923GGB	VG1241AE+923BGB	VG1241AE+923BUB
VG1241AF		2.9 ¹		VG1241AF+923AGB	VG1241AF+923GGB	VG1241AF+923BGB	VG1241AF+923BUB
VG1241AG		4.7 ¹		VG1241AG+923AGB	VG1241AG+923GGB	VG1241AG+923BGB	VG1241AG+923BUB
VG1241AL		7.4 ¹		VG1241AL+923AGB	VG1241AL+923GGB	VG1241AL+923BGB	VG1241AL+923BUB
VG1241AN		11.7		VG1241AN+923AGB	VG1241AN+923GGB	VG1241AN+923BGB	VG1241AN+923BUB
VG1241BG	3/4	4.7 ¹	200	VG1241BG+923AGB	VG1241BG+923GGB	VG1241BG+923BGB	VG1241BG+923BUB
VG1241BL		7.4 ¹		VG1241BL+923AGB	VG1241BL+923GGB	VG1241BL+923BGB	VG1241BL+923BUB
VG1241BN		11.7		VG1241BN+923AGB	VG1241BN+923GGB	VG1241BN+923BGB	VG1241BN+923BUB
VG1241CL	1	7.4 ¹	200	VG1241CL+923AGB	VG1241CL+923GGB	VG1241CL+923BGB	VG1241CL+923BUB
VG1241CN		11.7 ¹		VG1241CN+923AGB	VG1241CN+923GGB	VG1241CN+923BGB	VG1241CN+923BUB
VG1241CP		18.7		VG1241CP+923AGB	VG1241CP+923GGB	VG1241CP+923BGB	VG1241CP+923BUB
				Spring Return Open — Valve Normally Open — Actuators with Two Switches			
				VA9208-AGC-3	VA9208-GGC-3	VA9208-BGC-3	VA9208-BAC-3
VG1241DN	1-1/4	11.7 ¹	200	VG1241DN+938AGC	VG1241DN+938GGC	VG1241DN+938BGC	VG1241DN+938BAC
VG1241DP		18.7 ¹		VG1241DP+938AGC	VG1241DP+938GGC	VG1241DP+938BGC	VG1241DP+938BAC
VG1241DR		29.2		VG1241DR+938AGC	VG1241DR+938GGC	VG1241DR+938BGC	VG1241DR+938BAC
VG1241EP	1-1/2	18.7 ¹	200	VG1241EP+938AGC	VG1241EP+938GGC	VG1241EP+938BGC	VG1241EP+938BAC
VG1241ER		29.2 ¹		VG1241ER+938AGC	VG1241ER+938GGC	VG1241ER+938BGC	VG1241ER+938BAC
VG1241ES		46.8		VG1241ES+938AGC	VG1241ES+938GGC	VG1241ES+938BGC	VG1241ES+938BAC
VG1241FR	2	29.2 ¹	200	VG1241FR+938AGC	VG1241FR+938GGC	VG1241FR+938BGC	VG1241FR+938BAC
VG1241FS		46.8 ¹		VG1241FS+938AGC	VG1241FS+938GGC	VG1241FS+938BGC	VG1241FS+938BAC
VG1241FT		73.7		VG1241FT+938AGC	VG1241FT+938GGC	VG1241FT+938BGC	VG1241FT+938BAC

1. Valve has a characterizing disk.

VG1000 Series Two-Way, Plated Brass Trim, NPT End Connections Ball Valves with Spring-Return Electric Actuators with Switches (Continued)

Two-Way — Spring Return Valve Closed — Normally Closed with End Switches

Fluid Temperatures: 23°F to 203°F (-5°C to 95°C)				AC 24 V			AC 85–264 V (VA9203) AC 120 V (VA9208)
Valve	Size, in.	Cv	Closeoff psig	Floating	DC 0 to 10 V Proportional	On/Off	On/Off
				Spring Return Closed — Valve Normally Closed — Actuators with One Switch			
				VA9203-AGB-2Z	VA9203-GGB-2Z	VA9203-BGB-2	VA9203-BUB-2
VG1241AD	1/2	1.2 ¹	200	VG1241AD+943AGB	VG1241AD+943GGB	VG1241AD+943BGB	VG1241AD+943BUB
VG1241AE		1.9 ¹		VG1241AE+943AGB	VG1241AE+943GGB	VG1241AE+943BGB	VG1241AE+943BUB
VG1241AF		2.9 ¹		VG1241AF+943AGB	VG1241AF+943GGB	VG1241AF+943BGB	VG1241AF+943BUB
VG1241AG		4.7 ¹		VG1241AG+943AGB	VG1241AG+943GGB	VG1241AG+943BGB	VG1241AG+943BUB
VG1241AL		7.4 ¹		VG1241AL+943AGB	VG1241AL+943GGB	VG1241AL+943BGB	VG1241AL+943BUB
VG1241AN		11.7		VG1241AN+943AGB	VG1241AN+943GGB	VG1241AN+943BGB	VG1241AN+943BUB
VG1241BG	3/4	4.7 ¹	200	VG1241BG+943AGB	VG1241BG+943GGB	VG1241BG+943BGB	VG1241BG+943BUB
VG1241BL		7.4 ¹		VG1241BL+943AGB	VG1241BL+943GGB	VG1241BL+943BGB	VG1241BL+943BUB
VG1241BN		11.7		VG1241BN+943AGB	VG1241BN+943GGB	VG1241BN+943BGB	VG1241BN+943BUB
VG1241CL	1	7.4 ¹	200	VG1241CL+943AGB	VG1241CL+943GGB	VG1241CL+943BGB	VG1241CL+943BUB
VG1241CN		11.7 ¹		VG1241CN+943AGB	VG1241CN+943GGB	VG1241CN+943BGB	VG1241CN+943BUB
VG1241CP		18.7		VG1241CP+943AGB	VG1241CP+943GGB	VG1241CP+943BGB	VG1241CP+943BUB
				Spring Return Closed — Valve Normally Closed — Actuators with Two Switches			
				VA9208-AGC-3	VA9208-GGC-3	VA9208-BGC-3	VA9208-BAC-3
VG1241DN	1-1/4	11.7 ¹	200	VG1241DN+958AGC	VG1241DN+958GGC	VG1241DN+958BGC	VG1241DN+958BAC
VG1241DP		18.7 ¹		VG1241DP+958AGC	VG1241DP+958GGC	VG1241DP+958BGC	VG1241DP+958BAC
VG1241DR		29.2		VG1241DR+958AGC	VG1241DR+958GGC	VG1241DR+958BGC	VG1241DR+958BAC
VG1241EP	1-1/2	18.7 ¹	200	VG1241EP+958AGC	VG1241EP+958GGC	VG1241EP+958BGC	VG1241EP+958BAC
VG1241ER		29.2 ¹		VG1241ER+958AGC	VG1241ER+958GGC	VG1241ER+958BGC	VG1241ER+958BAC
VG1241ES		46.8		VG1241ES+958AGC	VG1241ES+958GGC	VG1241ES+958BGC	VG1241ES+958BAC
VG1241FR	2	29.2 ¹	200	VG1241FR+958AGC	VG1241FR+958GGC	VG1241FR+958BGC	VG1241FR+958BAC
VG1241FS		46.8 ¹		VG1241FS+958AGC	VG1241FS+958GGC	VG1241FS+958BGC	VG1241FS+958BAC
VG1241FT		73.7		VG1241FT+958AGC	VG1241FT+958GGC	VG1241FT+958BGC	VG1241FT+958BAC

1. Valve has a characterizing disk.

VG1000 Series Two-Way, Plated Brass Trim, NPT End Connections Ball Valves with Spring-Return Electric Actuators with Switches (Continued)

Technical Specifications

VG1000 Series Two-Way, Plated Brass Trim, NPT End Connections Ball Valves with Spring-Return Electric Actuators with Switches		
Service ¹		Hot Water, Chilled Water, 50/50 Glycol Solutions, and 15 psig (103 kPa) Saturated Steam for HVAC Systems
Fluid Temperature Limits	Water	23°F to 203°F (-5°C to 95°C)
	Steam	Not Rated for Steam Service
Valve Body Pressure Rating	Water	580 psig (4,000 kPa) (PN40)
	Steam	Not Rated for Steam Service
Maximum Closeoff Pressure		200 psid (1,378 kPa)
Maximum Recommended Operating Pressure Drop		50 psid (340 kPa)
Flow Characteristics	Two-Way	Equal Percentage
Rangeability ²		Greater than 500:1
Minimum Ambient Operating Temperature	-22°F (-30°C)	VA9203 Series Spring-Return Actuators
	-40°F (-40°C)	VA9208 Series Spring-Return Actuators
Maximum Ambient Operating Temperature ³ (Limited by the Actuator and Linkage)	Direct Mount	140°F (60°C): VA9208 Series Spring-Return Actuators
Leakage		0.01% of Maximum Flow per ANSI/FCI 70-2, Class 4
End Connections		National Pipe Thread (NPT)
Materials	Body	Forged Brass
	Ball	Chrome Plated Brass
	Blowout-Proof Stem	Nickel Plated Brass
	Seats	Graphite-Reinforced PTFE with Ethylene Propylene Diene Monomer (EPDM) O-Ring Backing
	Stem Seals	EPDM Double O-Rings
	Characterizing Disk	Amodel® AS-1145HS Polyphthalamide Resin

1. Proper water treatment is recommended; refer to the VDI 2035 Guideline.
2. Rangeability is defined as the ratio of maximum controllable flow to minimum controllable flow.
3. In steam applications, install the valve with the stem horizontal to the piping and wrap the valve and piping with insulation.



This product is made of copper alloy, which contains lead. The product is therefore not to be used on drinking water.



This product can expose you to chemicals including lead, which is known to the State of California to cause cancer, birth defects, or other reproductive harm. For more information, go to www.P65Warnings.ca.gov.

WARNING: BRASS MAY CONTAIN LEAD

To fulfill our obligations towards Article 33, in accordance to the European REACH Regulation No 1907/2006 EC, we hereby inform you that this article contains the following Substances of Very High Concern mentioned on the Candidate list:

- Lead

VG1000 Series Three-Way, Plated Brass Ball and Stem, NPT End Connections Ball Valve Assemblies with End Switches

Description

VG1000 Series Ball Valves are designed to regulate the flow of hot or chilled water and, for some models, low-pressure steam in response to the demand of a controller in HVAC systems. Available in sizes 1/2 through 2 in. (DN15 through DN50), this family of two- and three-way forged brass valves is factory or field mounted to Johnson Controls® VA9104, M9106, M9109, and M9100 Series Non-Spring-Return and VA9203 and VA9208 Series Spring-Return Electric Actuators for on/off, floating, or proportional control.

Refer to the *VG1000 Series Forged Brass Ball Valves Product Bulletin (LIT-977132)* for important product application information.

Features

- Forged Brass Body — provides 580 psig static pressure rating.
- Chrome-Plated Brass Ball and Stem Assembly Standard — handles both chilled and hot water applications with a fluid temperature range of 23°F to 203°F (-5°C to 95°C).
- Graphite-Reinforced Polytetrafluoroethylene (PTFE) Seats — include 15% graphite-reinforced ball seals, providing better wear resistance.
- 500:1 Rangeability — provides accurate control under all load conditions.
- Maintenance-Free Design — performs without failure in excess of 200,000 full stroke cycles in iron-oxide contaminated water.



VG1000 Series Three-Way, Spring-Return, Plated Brass Ball and Stem Ball Valve Assemblies with End Switches

Repair Information

If the VG1000 Series Ball Valve fails to operate within its specifications, replace the valve body, actuator, or entire assembly. For replacement parts, contact the nearest Johnson Controls representative.

Selection Charts

Three-Way — Spring Return Valve Counterclockwise — Port A (Coil) Open with Switches

Fluid Temperatures: 23°F to 203°F (-5°C to 95°C)				AC 24 V			AC 85–264 V (VA9203) AC 120 V (VA9208)
Valve	Size, in.	Cv Port A/B	Closeoff psig	Floating	DC 0 to 10 V Proportional	On/Off	On/Off
				Spring Return Port A Open — Valve Spring Return Counterclockwise — Actuator with One Switch			
				VA9203-AGB-2Z	VA9203-GGB-2Z	VA9203-BGB-2	VA9203-BUB-2
VG1841AD	1/2	1.2/0.7 ¹	200	VG1841AD+923AGB	VG1841AD+923GGB	VG1841AD+923BGB	VG1841AD+923BUB
VG1841AE		1.9/1.2 ¹		VG1841AE+923AGB	VG1841AE+923GGB	VG1841AE+923BGB	VG1841AE+923BUB
VG1841AF		2.9/1.9 ¹		VG1841AF+923AGB	VG1841AF+923GGB	VG1841AF+923BGB	VG1841AF+923BUB
VG1841AG		4.7/2.9 ¹		VG1841AG+923AGB	VG1841AG+923GGB	VG1841AG+923BGB	VG1841AG+923BUB
VG1841AL		7.4/4.7 ¹		VG1841AL+923AGB	VG1841AL+923GGB	VG1841AL+923BGB	VG1841AL+923BUB
VG1841AN		11.7/5.8		VG1841AN+923AGB	VG1841AN+923GGB	VG1841AN+923BGB	VG1841AN+923BUB
VG1841BG	3/4	4.7/2.9 ¹	200	VG1841BG+923AGB	VG1841BG+923GGB	VG1841BG+923BGB	VG1841BG+923BUB
VG1841BL		7.4/4.7 ¹		VG1841BL+923AGB	VG1841BL+923GGB	VG1841BL+923BGB	VG1841BL+923BUB
VG1841BN		11.7/5.8		VG1841BN+923AGB	VG1841BN+923GGB	VG1841BN+923BGB	VG1841BN+923BUB
VG1841CL	1	7.4/4.7 ¹	200	VG1841CL+923AGB	VG1841CL+923GGB	VG1841CL+923BGB	VG1841CL+923BUB
VG1841CN		11.7/7.4 ¹		VG1841CN+923AGB	VG1841CN+923GGB	VG1841CN+923BGB	VG1841CN+923BUB
VG1841CP		18.7/9.4		VG1841CP+923AGB	VG1841CP+923GGB	VG1841CP+923BGB	VG1841CP+923BUB
				Spring Return Port A Open — Valve Spring Return Counterclockwise — Actuator with Two Switches			
				VA9208-AGC-3	VA9208-GGC-3	VA9208-BGC-3	VA9208-BAC-3
VG1841DN	1-1/4	11.7/7.4 ¹	200	VG1841DN+938AGC	VG1841DN+938GGC	VG1841DN+938BGC	VG1841DN+938BAC
VG1841DP		18.7/9.4 ¹		VG1841DP+938AGC	VG1841DP+938GGC	VG1841DP+938BGC	VG1841DP+938BAC
VG1841DR		29.2/14.6		VG1841DR+938AGC	VG1841DR+938GGC	VG1841DR+938BGC	VG1841DR+938BAC
VG1841EP	1-1/2	18.7/11.7 ¹	200	VG1841EP+938AGC	VG1841EP+938GGC	VG1841EP+938BGC	VG1841EP+938BAC
VG1841ER		29.2/14.6 ¹		VG1841ER+938AGC	VG1841ER+938GGC	VG1841ER+938BGC	VG1841ER+938BAC
VG1841ES		46.8/23.4		VG1841ES+938AGC	VG1841ES+938GGC	VG1841ES+938BGC	VG1841ES+938BAC
VG1841FR	2	29.2/18.7 ¹	200	VG1841FR+938AGC	VG1841FR+938GGC	VG1841FR+938BGC	VG1841FR+938BAC
VG1841FS		46.8/29.2 ¹		VG1841FS+938AGC	VG1841FS+938GGC	VG1841FS+938BGC	VG1841FS+938BAC
VG1841FT		73.7/36.8		VG1841FT+938AGC	VG1841FT+938GGC	VG1841FT+938BGC	VG1841FT+938BAC

1. Valve has a characterizing disk.

VG1000 Series Three-Way, Plated Brass Ball and Stem, NPT End Connections Ball Valve Assemblies with End Switches (Continued)

Three-Way — Spring Return Valve Clockwise — Port A (Coil) Closed with End Switches

Fluid Temperatures: 23°F to 203°F (-5°C to 95°C)				AC 24 V			AC 85–264 V (VA9203) AC 120 V (VA9208)
Valve	Size, in.	Cv Port A/B	Closeoff psig	Floating	DC 0 to 10 V Proportional	On/Off	On/Off
				Spring Return Port A Closed — Valve Spring Return Clockwise — Actuator with One Switch			
				VA9203-AGB-2Z	VA9203-GGB-2Z	VA9203-BGB-2	VA9203-BUB-2
VG1841AD	1/2	1.2/0.7 ¹	200	VG1841AD+943AGB	VG1841AD+943GGB	VG1841AD+943BGB	VG1841AD+943BUB
VG1841AE		1.9/1.2 ¹		VG1841AE+943AGB	VG1841AE+943GGB	VG1841AE+943BGB	VG1841AE+943BUB
VG1841AF		2.9/1.9 ¹		VG1841AF+943AGB	VG1841AF+943GGB	VG1841AF+943BGB	VG1841AF+943BUB
VG1841AG		4.7/2.9 ¹		VG1841AG+943AGB	VG1841AG+943GGB	VG1841AG+943BGB	VG1841AG+943BUB
VG1841AL		7.4/4.7 ¹		VG1841AL+943AGB	VG1841AL+943GGB	VG1841AL+943BGB	VG1841AL+943BUB
VG1841AN		11.7/5.8		VG1841AN+943AGB	VG1841AN+943GGB	VG1841AN+943BGB	VG1841AN+943BUB
VG1841BG	3/4	4.7/2.9 ¹	200	VG1841BG+943AGB	VG1841BG+943GGB	VG1841BG+943BGB	VG1841BG+943BUB
VG1841BL		7.4/4.7 ¹		VG1841BL+943AGB	VG1841BL+943GGB	VG1841BL+943BGB	VG1841BL+943BUB
VG1841BN		11.7/5.8		VG1841BN+943AGB	VG1841BN+943GGB	VG1841BN+943BGB	VG1841BN+943BUB
VG1841CL	1	7.4/4.7 ¹	200	VG1841CL+943AGB	VG1841CL+943GGB	VG1841CL+943BGB	VG1841CL+943BUB
VG1841CN		11.7/7.4 ¹		VG1841CN+943AGB	VG1841CN+943GGB	VG1841CN+943BGB	VG1841CN+943BUB
VG1841CP		18.7/9.4		VG1841CP+943AGB	VG1841CP+943GGB	VG1841CP+943BGB	VG1841CP+943BUB
				Spring Return Port A Closed — Valve Spring Return Clockwise — Actuator with Two Switches			
				VA9208-AGC-3	VA9208-GGC-3	VA9208-BGC-3	VA9208-BAC-3
VG1841DN	1-1/4	11.7/7.4 ¹	200	VG1841DN+958AGC	VG1841DN+958GGC	VG1841DN+958BGC	VG1841DN+958BAC
VG1841DP		18.7/9.4 ¹		VG1841DP+958AGC	VG1841DP+958GGC	VG1841DP+958BGC	VG1841DP+958BAC
VG1841DR		29.2/14.6		VG1841DR+958AGC	VG1841DR+958GGC	VG1841DR+958BGC	VG1841DR+958BAC
VG1841EP	1-1/2	18.7/11.7 ¹	200	VG1841EP+958AGC	VG1841EP+958GGC	VG1841EP+958BGC	VG1841EP+958BAC
VG1841ER		29.2/14.6 ¹		VG1841ER+958AGC	VG1841ER+958GGC	VG1841ER+958BGC	VG1841ER+958BAC
VG1841ES		46.8/23.4		VG1841ES+958AGC	VG1841ES+958GGC	VG1841ES+958BGC	VG1841ES+958BAC
VG1841FR	2	29.2/18.7 ¹	200	VG1841FR+958AGC	VG1841FR+958GGC	VG1841FR+958BGC	VG1841FR+958BAC
VG1841FS		46.8/29.2 ¹		VG1841FS+958AGC	VG1841FS+958GGC	VG1841FS+958BGC	VG1841FS+958BAC
VG1841FT		73.7/36.8		VG1841FT+958AGC	VG1841FT+958GGC	VG1841FT+958BGC	VG1841FT+958BAC

1. Valve has a characterizing disk.

VG1000 Series Three-Way, Plated Brass Ball and Stem, NPT End Connections Ball Valve Assemblies with End Switches (Continued)

Technical Specifications

VG1000 Series Three-Way, Plated Brass Ball and Stem, NPT End Connections Ball Valve Assemblies with End Switches		
Service ¹		Hot Water, Chilled Water, 50/50 Glycol Solutions
Fluid Temperature Limits	Water	23°F to 203°F (-5°C to 95°C)
	Steam	Not Rated for Steam Service
Valve Body Pressure Rating	Water	580 psig (4,000 kPa) (PN40)
	Steam	Not Rated for Steam Service
Maximum Closeoff Pressure		200 psid (1,378 kPa)
Maximum Recommended Operating Pressure Drop		50 psid (340 kPa)
Flow Characteristics	Three-Way	Equal Percentage Flow Characteristics of In-Line Port A (Coil) and Linear Flow Characteristics of Angle Port B (Bypass)
Rangeability ²		Greater than 500:1
Minimum Ambient Operating Temperature	-22°F (-30°C)	VA9203 Series Spring-Return Actuators
	-40°F (-40°C)	VA9208 Series Spring-Return Actuators
Maximum Ambient Operating Temperature	140°F (60°C)	VA9203 or VA9208 Series Spring-Return Actuators
Leakage		0.01% of Maximum Flow per ANSI/FCI 70-2, Class 4
		1% of Maximum Flow for Three-Way Bypass Port
End Connections		National Pipe Thread (NPT)
Materials	Body	Forged Brass
	Ball	Chrome Plated Brass
	Blowout-Proof Stem	Nickel Plated Brass
	Seats	Graphite-Reinforced Polytetrafluoroethylene (PTFE) with Ethylene Propylene Diene Monomer (EPDM) O-Ring Backing
	Stem Seals	EPDM Double O-Rings
	Characterizing Disk	Amodel® AS-1145HS Polyphthalamide Resin

1. Proper water treatment is recommended; refer to the VDI 2035 Guideline.
2. Rangeability is defined as the ratio of maximum controllable flow to minimum controllable flow.



WARNING This product is made of copper alloy, which contains lead. The product is therefore not to be used on drinking water.



WARNING This product can expose you to chemicals including lead, which is known to the State of California to cause cancer, birth defects, or other reproductive harm. For more information, go to www.P65Warnings.ca.gov.

WARNING: BRASS MAY CONTAIN LEAD

To fulfill our obligations towards Article 33, in accordance to the European REACH Regulation No 1907/2006 EC, we hereby inform you that this article contains the following Substances of Very High Concern mentioned on the Candidate list:

- Lead

VG1000 Series Three-Way, Plated Brass Trim, NPT End Connections Ball Valves with Spring-Return Electric Actuators without Switches

Description

VG1000 Series Ball Valves are designed to regulate the flow of hot or chilled water and, for some models, low pressure steam in response to the demand of a controller in HVAC systems. Available in sizes 1/2 through 2 in. (DN15 through DN50), this family of two- and three-way forged brass valves is factory or field mounted to Johnson Controls® VA9104, M9106, M9109, and M9100 Series Non-Spring-Return and VA9203 and VA9208 Series Spring-Return Electric Actuators for on/off, floating, or proportional control.

Refer to the *VG1000 Series Forged Brass Ball Valves Product Bulletin (LIT-977132)* for important product application information.

Features

- Forged Brass Body — provides 580 psig static pressure rating.
- Chrome-Plated Brass Ball and Stem Assembly Standard — handles both chilled and hot water applications with a fluid temperature range of 23°F to 203°F (-5°C to 95°C).
- Graphite-Reinforced Polytetrafluoroethylene (PTFE) Seats — include 15% graphite-reinforced ball seals, providing better wear resistance.
- 500:1 Rangeability — provides accurate control under all load conditions.
- Maintenance-Free Design — performs without failure in excess of 200,000 full stroke cycles in iron-oxide contaminated water.



Three-Way, Spring-Return, Plated Brass Ball and Stem Ball Valve Assemblies with End Switches

Repair Information

If the VG1000 Series Ball Valve fails to operate within its specifications, replace the valve body, actuator, or entire assembly. For replacement parts, contact the nearest Johnson Controls representative.

Selection Chart

Three-Way — Spring Return — without Switches (Part 1 of 2)

Fluid Temperatures: 23°F to 203°F (-5°C to 95°C)				AC 24 V			AC-85-264V (VA9203) AC 120 V (VA9208)
Valve	Size, in. (mm)	Cv	Closeoff psig	Floating	DC 0 to 10 V Proportional	On/Off	On/Off
				Spring Return Port A Open — Valve Spring Return Counterclockwise			
				VA9203-AGA-2Z	VA9203-GGA-2Z	VA9203-BGA-2	VA9203-BUA-2
VG1841AD	1/2	1.2/0.7 ¹	200	VG1841AD+923AGA	VG1841AD+923GGA	VG1841AD+923BGA	VG1841AD+923BUA
VG1841AE		1.9/1.2 ¹		VG1841AE+923AGA	VG1841AE+923GGA	VG1841AE+923BGA	VG1841AE+923BUA
VG1841AF		2.9/1.9 ¹		VG1841AF+923AGA	VG1841AF+923GGA	VG1841AF+923BGA	VG1841AF+923BUA
VG1841AG		4.7/2.9 ¹		VG1841AG+923AGA	VG1841AG+923GGA	VG1841AG+923BGA	VG1841AG+923BUA
VG1841AL		7.4/4.7 ¹		VG1841AL+923AGA	VG1841AL+923GGA	VG1841AL+923BGA	VG1841AL+923BUA
VG1841AN		11.7/7.4		VG1841AN+923AGA	VG1841AN+923GGA	VG1841AN+923BGA	VG1841AN+923BUA
VG1841BG	3/4	4.7/2.9 ¹	200	VG1841BG+923AGA	VG1841BG+923GGA	VG1841BG+923BGA	VG1841BG+923BUA
VG1841BL		7.4/4.7 ¹		VG1841BL+923AGA	VG1841BL+923GGA	VG1841BL+923BGA	VG1841BL+923BUA
VG1841BN		11.7/11.7		VG1841BN+923AGA	VG1841BN+923GGA	VG1841BN+923BGA	VG1841BN+923BUA
VG1841CL	1	7.4/4.7 ¹	200	VG1841CL+923AGA	VG1841CL+923GGA	VG1841CL+923BGA	VG1841CL+923BUA
VG1841CN		11.7/7.4 ¹		VG1841CN+923AGA	VG1841CN+923GGA	VG1841CN+923BGA	VG1841CN+923BUA
VG1841CP		18.7/11.7		VG1841CP+923AGA	VG1841CP+923GGA	VG1841CP+923BGA	VG1841CP+923BUA
				Spring Return Port A Open — Valve Spring Return Counterclockwise			
				VA9208-AGA-2	VA9208-GGA-2	VA9208-BGA-3	VA9208-BAA-3
VG1841DN	1-1/4	11.7/7.4 ¹	200	VG1841DN+928AGA	VG1841DN+928GGA	VG1841DN+938BGA	VG1841DN+938BAA
VG1841DP		18.7/11.7 ¹		VG1841DP+928AGA	VG1841DP+928GGA	VG1841DP+938BGA	VG1841DP+938BAA
VG1841DR		29.2/18.7		VG1841DR+928AGA	VG1841DR+928GGA	VG1841DR+938BGA	VG1841DR+938BAA
VG1841EP	1-1/2	18.7/11.7 ¹	200	VG1841EP+928AGA	VG1841EP+928GGA	VG1841EP+938BGA	VG1841EP+938BAA
VG1841ER		29.2/18.7 ¹		VG1841ER+928AGA	VG1841ER+928GGA	VG1841ER+938BGA	VG1841ER+938BAA
VG1841ES		46.8/29.2		VG1841ES+928AGA	VG1841ES+928GGA	VG1841ES+938BGA	VG1841ES+938BAA
VG1841FR	2	29.2/18.7 ¹	200	VG1841FR+928AGA	VG1841FR+928GGA	VG1841FR+938BGA	VG1841FR+938BAA
VG1841FS		46.8/29.2 ¹		VG1841FS+928AGA	VG1841FS+928GGA	VG1841FS+938BGA	VG1841FS+938BAA
VG1841FT		73.7/36.8		VG1841FT+928AGA	VG1841FT+928GGA	VG1841FT+938BGA	VG1841FT+938BAA

The performance specifications are nominal and conform to acceptable industry standards. For applications at conditions beyond these specifications, consult the local Johnson Controls office. Johnson Controls shall not be liable for damages resulting from misapplication or misuse of its products. © 2019 Johnson Controls. www.johnsoncontrols.com

VG1000 Series Three-Way, Plated Brass Trim, NPT End Connections Ball Valves with Spring-Return Electric Actuators without Switches (Continued)

Three-Way — Spring Return — without Switches (Part 2 of 2)

Fluid Temperatures: 23°F to 203°F (-5°C to 95°C)				AC 24 V			AC-85-264V (VA9203) AC 120 V (VA9208)
Valve	Size, in. (mm)	Cv	Closeoff psig	Floating	DC 0 to 10 V Proportional	On/Off	On/Off
				Spring Return Port A Closed — Valve Spring Return Clockwise			
				VA9203-AGA-2Z	VA9203-GGA-2Z	VA9203-BGA-2	VA9203-BUA-2
VG1841AD	1/2	1.2/0.7 ¹	200	VG1841AD+943AGA	VG1841AD+943GGA	VG1841AD+943BGA	VG1841AD+943BUA
VG1841AE		1.9/1.2 ¹		VG1841AE+943AGA	VG1841AE+943GGA	VG1841AE+943BGA	VG1841AE+943BUA
VG1841AF		2.9/1.9 ¹		VG1841AF+943AGA	VG1841AF+943GGA	VG1841AF+943BGA	VG1841AF+943BUA
VG1841AG		4.7/2.9 ¹		VG1841AG+943AGA	VG1841AG+943GGA	VG1841AG+943BGA	VG1841AG+943BUA
VG1841AL		7.4/4.7 ¹		VG1841AL+943AGA	VG1841AL+943GGA	VG1841AL+943BGA	VG1841AL+943BUA
VG1841AN		11.7/7.4 ¹		VG1841AN+943AGA	VG1841AN+943GGA	VG1841AN+943BGA	VG1841AN+943BUA
VG1841BG	3/4	4.7/2.9 ¹	200	VG1841BG+943AGA	VG1841BG+943GGA	VG1841BG+943BGA	VG1841BG+943BUA
VG1841BL		7.4/4.7 ¹		VG1841BL+943AGA	VG1841BL+943GGA	VG1841BL+943BGA	VG1841BL+943BUA
VG1841BN		11.7/7.4 ¹		VG1841BN+943AGA	VG1841BN+943GGA	VG1841BN+943BGA	VG1841BN+943BUA
VG1841CL	1	7.4/4.7 ¹	200	VG1841CL+943AGA	VG1841CL+943GGA	VG1841CL+943BGA	VG1841CL+943BUA
VG1841CN		11.7/7.4 ¹		VG1841CN+943AGA	VG1841CN+943GGA	VG1841CN+943BGA	VG1841CN+943BUA
VG1841CP		18.7/11.7 ¹		VG1841CP+943AGA	VG1841CP+943GGA	VG1841CP+943BGA	VG1841CP+943BUA
				Spring Return Port A Closed — Valve Spring Return Clockwise			
				VA9208-AGA-2	VA9208-GGA-2	VA9208-BGA-3	VA9208-BAA-3
VG1841DN	1-1/4	11.7/7.4 ¹	200	VG1841DN+948AGA	VG1841DN+948GGA	VG1841DN+958BGA	VG1841DN+958BAA
VG1841DP		18.7/11.7 ¹		VG1841DP+948AGA	VG1841DP+948GGA	VG1841DP+958BGA	VG1841DP+958BAA
VG1841DR		29.2/18.7 ¹		VG1841DR+948AGA	VG1841DR+948GGA	VG1841DR+958BGA	VG1841DR+958BAA
VG1841EP	1-1/2	18.7/11.7 ¹	200	VG1841EP+948AGA	VG1841EP+948GGA	VG1841EP+958BGA	VG1841EP+958BAA
VG1841ER		29.2/18.7 ¹		VG1841ER+948AGA	VG1841ER+948GGA	VG1841ER+958BGA	VG1841ER+958BAA
VG1841ES		46.8/29.2 ¹		VG1841ES+948AGA	VG1841ES+948GGA	VG1841ES+958BGA	VG1841ES+958BAA
VG1841FR	2	29.2/18.7 ¹	200	VG1841FR+948AGA	VG1841FR+948GGA	VG1841FR+958BGA	VG1841FR+958BAA
VG1841FS		46.8/29.2 ¹		VG1841FS+948AGA	VG1841FS+948GGA	VG1841FS+958BGA	VG1841FS+958BAA
VG1841FT		73.7/36.8 ¹		VG1841FT+948AGA	VG1841FT+948GGA	VG1841FT+958BGA	VG1841FT+958BAA

1. Valve has a characterizing disk.

VG1000 Series Three-Way, Plated Brass Trim, NPT End Connections Ball Valves with Spring-Return Electric Actuators without Switches (Continued)

Technical Specifications

VG1000 Series Three-Way, Plated Brass Trim, NPT End Connections Ball Valves with Spring-Return Electric Actuators without Switches		
Service¹		Hot Water, Chilled Water, 50/50 Glycol Solutions
Fluid Temperature Limits	Water	23°F to 203°F (-5°C to 95°C)
	Steam	Not Rated for Steam Service
Valve Body Pressure Rating	Water	580 psig (4,000 kPa) (PN40)
	Steam	Not Rated for Steam Service
Maximum Closeoff Pressure		200 psid (1,378 kPa)
Maximum Recommended Operating Pressure Drop		50 psid (340 kPa)
Flow Characteristics	Three-Way	Equal Percentage Flow Characteristics of In-Line Port A (Coil) and Linear Flow Characteristics of Angle Port B (Bypass)
Rangeability²		Greater than 500:1
Minimum Ambient Operating Temperature	-22°F (-30°C)	VA9203 Series Spring-Return Actuators
	-40°F (40°C)	VA9208 Series Spring-Return Actuators
Maximum Ambient Operating Temperature³ (Limited by the Actuator and Linkage)	140°F (60°C)	Direct Mount: VA9203 or VA9208 Series Spring-Return Actuators
Leakage		0.01% of Maximum Flow per ANSI/FCI 70-2, Class 4 1% of Maximum Flow for Three-Way Bypass Port
End Connections		National Pipe Thread (NPT)
Materials	Body	Forged Brass
	Ball	Chrome Plated Brass
	Blowout-Proof Stem	Nickel Plated Brass
	Seats	Graphite-Reinforced PTFE with Ethylene Propylene Diene Monomer (EPDM) O-Ring Backing
	Stem Seals	EPDM Double O-Rings
	Characterizing Disk	Amodel® AS-1145HS Polyphthalamide Resin

1. Proper water treatment is recommended; refer to the VDI 2035 Guideline.
2. Rangeability is defined as the ratio of maximum controllable flow to minimum controllable flow.
3. In steam applications, install the valve with the stem horizontal to the piping and wrap the valve and piping with insulation.



WARNING This product is made of copper alloy, which contains lead. The product is therefore not to be used on drinking water.



WARNING This product can expose you to chemicals including lead, which is known to the State of California to cause cancer, birth defects, or other reproductive harm. For more information, go to www.P65Warnings.ca.gov.

WARNING: BRASS MAY CONTAIN LEAD

To fulfill our obligations towards Article 33, in accordance to the European REACH Regulation No 1907/2006 EC, we hereby inform you that this article contains the following Substances of Very High Concern mentioned on the Candidate list:

- Lead

VG1000 Series Two-Way, Stainless Steel Trim, NPT End Connections Ball Valves with Non-Spring Return Electric Actuators

Description

VG1000 Series Ball Valves are designed to regulate the flow of hot or chilled water and, for some models, low-pressure steam in response to the demand of a controller in HVAC systems. Available in sizes 1/2 through 2 in. (DN15 through DN50), this family of two- and three-way forged brass valves is factory or field mounted to Johnson Controls® VA9104 and VA9300 Series Non-Spring-Return and VA9203 and VA9208 Series Spring-Return Electric Actuators for on/off, floating or proportional control.

Refer to the *VG1000 Series Forged Brass Ball Valves Product Bulletin (LIT-977132)* for important product application and single point of contact information.

Features

- Forged Brass Body — provides 580 psig static pressure rating.
- 200 psi Closeoff Pressure Rating — provides tight shutoff.
- 300 Series Stainless Steel Ball and Stem Assembly — tolerates high-temperature water or 15 psi saturated steam with fluid temperatures of -22°F to 284°F (-30°C to 140°C) or where a higher degree of corrosion protection is desired.
- 500:1 Rangeability — provides accurate control under all load conditions.

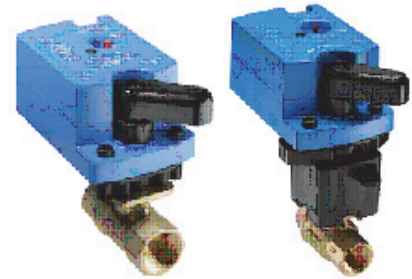

VG1000 Series Two-Way, Non-Spring Return, Stainless Steel Ball and Stem Ball Valve Assemblies

Repair Information

If the VG1000 Series Ball Valve Assembly fails to operate within its specifications, replace the valve body, actuator, or entire assembly. For replacement parts, contact the nearest Johnson Controls representative.

Selection Charts

Two-Way Stainless Steel Trim Ball Valves, Non-Spring Return, VA9104 Series Electric Actuators without Switches

Fluid Temperatures: -4°F to 212°F (-20°C to 100°C) Not Rated for Steam Service				AC 24 V		
Valve	Size, in.	Cv	Closeoff psig	On/Off and/or Floating without Timeout ¹	On/Off and/or Floating with Timeout	DC 0 to 10 V Proportional
Actuators with M3 Screw Terminals				VA9104-AGA-3S	VA9104-IGA-3S	VA9104-GGA-3S
VG1245AD	1/2	1.2 ²	200	VG1245AD+9T4AGA	VG1245AD+9T4IGA	VG1245AD+9T4GGA
VG1245AE		1.9 ²		VG1245AE+9T4AGA	VG1245AE+9T4IGA	VG1245AE+9T4GGA
VG1245AF		2.9 ²		VG1245AF+9T4AGA	VG1245AF+9T4IGA	VG1245AF+9T4GGA
VG1245AG		4.7 ²		VG1245AG+9T4AGA	VG1245AG+9T4IGA	VG1245AG+9T4GGA
VG1245AL		7.4 ²		VG1245AL+9T4AGA	VG1245AL+9T4IGA	VG1245AL+9T4GGA
VG1245AN		11.7		VG1245AN+9T4AGA	VG1245AN+9T4IGA	VG1245AN+9T4GGA
VG1245BG	3/4	4.7 ²	200	VG1245BG+9T4AGA	VG1245BG+9T4IGA	VG1245BG+9T4GGA
VG1245BL		7.4 ²		VG1245BL+9T4AGA	VG1245BL+9T4IGA	VG1245BL+9T4GGA
VG1245BN		11.7		VG1245BN+9T4AGA	VG1245BN+9T4IGA	VG1245BN+9T4GGA
VG1245CL	1	7.4 ²	200	VG1245CL+9T4AGA	VG1245CL+9T4IGA	VG1245CL+9T4GGA
VG1245CN		11.7 ²		VG1245CN+9T4AGA	VG1245CN+9T4IGA	VG1245CN+9T4GGA
VG1245CP		18.7		VG1245CP+9T4AGA	VG1245CP+9T4IGA	VG1245CP+9T4GGA
Actuators with 120 in. (3.05 m) 18 AWG Plenum Cable				VA9104-AGA-2S	VA9104-IGA-2S	VA9104-GGA-2S
VG1245AD	1/2	1.2 ²	200	VG1245AD+9A4AGA	VG1245AD+9A4IGA	VG1245AD+9A4GGA
VG1245AE		1.9 ²		VG1245AE+9A4AGA	VG1245AE+9A4IGA	VG1245AE+9A4GGA
VG1245AF		2.9 ²		VG1245AF+9A4AGA	VG1245AF+9A4IGA	VG1245AF+9A4GGA
VG1245AG		4.7 ²		VG1245AG+9A4AGA	VG1245AG+9A4IGA	VG1245AG+9A4GGA
VG1245AL		7.4 ²		VG1245AL+9A4AGA	VG1245AL+9A4IGA	VG1245AL+9A4GGA
VG1245AN		11.7		VG1245AN+9A4AGA	VG1245AN+9A4IGA	VG1245AN+9A4GGA
VG1245BG	3/4	4.7 ²	200	VG1245BG+9A4AGA	VG1245BG+9A4IGA	VG1245BG+9A4GGA
VG1245BL		7.4 ²		VG1245BL+9A4AGA	VG1245BL+9A4IGA	VG1245BL+9A4GGA
VG1245BN		11.7		VG1245BN+9A4AGA	VG1245BN+9A4IGA	VG1245BN+9A4GGA
VG1245CL	1	7.4 ²	200	VG1245CL+9A4AGA	VG1245CL+9A4IGA	VG1245CL+9A4GGA
VG1245CN		11.7 ²		VG1245CN+9A4AGA	VG1245CN+9A4IGA	VG1245CN+9A4GGA
VG1245CP		18.7		VG1245CP+9A4AGA	VG1245CP+9A4IGA	VG1245CP+9A4GGA

1. To avoid excessive wear or drive time on the motor for the AGx models, use a controller or software that provides a timeout function to remove the signal at the end of rotation (stall).
2. Valve has a characterizing disk.

VG1000 Series Two-Way, Stainless Steel Trim, NPT End Connections Ball Valves with Non-Spring Return Electric Actuators (Continued)

Two-Way Stainless Steel Trim Ball Valves, Non-Spring Return, VA9104 Series Electric Actuators without Switches with Optional M9000-561 Thermal Barrier

Fluid Temperatures: -22°F to 284°F (-30°C to 140°C) Water and 15 psi Saturated Steam				AC 24 V		
Valve	Size, in.	Cv	Closeoff psig	On/Off and/or Floating without Timeout ¹	On/Off and/or Floating with Timeout	DC 0 to 10 V Proportional
Actuators with M3 Screw Terminals with M9000-561 Thermal Barrier Installed				VA9104-AGA-3S	VA9104-IGA-3S	VA9104-GGA-3S
VG1245AD	1/2	1.2 ²	200	VG1245ADH9T4AGA	VG1245ADH9T4IGA	VG1245ADH9T4GGA
VG1245AE		1.9 ²		VG1245AEH9T4AGA	VG1245AEH9T4IGA	VG1245AEH9T4GGA
VG1245AF		2.9 ²		VG1245AFH9T4AGA	VG1245AFH9T4IGA	VG1245AFH9T4GGA
VG1245AG		4.7 ²		VG1245AGH9T4AGA	VG1245AGH9T4IGA	VG1245AGH9T4GGA
VG1245AL		7.4 ²		VG1245ALH9T4AGA	VG1245ALH9T4IGA	VG1245ALH9T4GGA
VG1245AN		11.7		VG1245ANH9T4AGA	VG1245ANH9T4IGA	VG1245ANH9T4GGA
VG1245BG	3/4	4.7 ²	200	VG1245BGH9T4AGA	VG1245BGH9T4IGA	VG1245BGH9T4GGA
VG1245BL		7.4 ²		VG1245BLH9T4AGA	VG1245BLH9T4IGA	VG1245BLH9T4GGA
VG1245BN		11.7		VG1245BNH9T4AGA	VG1245BNH9T4IGA	VG1245BNH9T4GGA
VG1245CL	1	7.4 ²	200	VG1245CLH9T4AGA	VG1245CLH9T4IGA	VG1245CLH9T4GGA
VG1245CN		11.7 ²		VG1245CNH9T4AGA	VG1245CNH9T4IGA	VG1245CNH9T4GGA
VG1245CP		18.7		VG1245CPH9T4AGA	VG1245CPH9T4IGA	VG1245CPH9T4GGA
Actuators with 120 in. (3.05 m) 18 AWG Plenum Cable with M9000-561 Thermal Barrier Installed				VA9104-AGA-2S	VA9104-IGA-2S	VA9104-GGA-2S
VG1245AD	1/2	1.2 ²	200	VG1245ADH9A4AGA	VG1245ADH9A4IGA	VG1245ADH9A4GGA
VG1245AE		1.9 ²		VG1245AEH9A4AGA	VG1245AEH9A4IGA	VG1245AEH9A4GGA
VG1245AF		2.9 ²		VG1245AFH9A4AGA	VG1245AFH9A4IGA	VG1245AFH9A4GGA
VG1245AG		4.7 ²		VG1245AGH9A4AGA	VG1245AGH9A4IGA	VG1245AGH9A4GGA
VG1245AL		7.4 ²		VG1245ALH9A4AGA	VG1245ALH9A4IGA	VG1245ALH9A4GGA
VG1245AN		11.7		VG1245ANH9A4AGA	VG1245ANH9A4IGA	VG1245ANH9A4GGA
VG1245BG	3/4	4.7 ²	200	VG1245BGH9A4AGA	VG1245BGH9A4IGA	VG1245BGH9A4GGA
VG1245BL		7.4 ²		VG1245BLH9A4AGA	VG1245BLH9A4IGA	VG1245BLH9A4GGA
VG1245BN		11.7		VG1245BNH9A4AGA	VG1245BNH9A4IGA	VG1245BNH9A4GGA
VG1245CL	1	7.4 ²	200	VG1245CLH9A4AGA	VG1245CLH9A4IGA	VG1245CLH9A4GGA
VG1245CN		11.7 ²		VG1245CNH9A4AGA	VG1245CNH9A4IGA	VG1245CNH9A4GGA
VG1245CP		18.7		VG1245CPH9A4AGA	VG1245CPH9A4IGA	VG1245CPH9A4GGA

1. To avoid excessive wear or drive time on the motor for the AGx models, use a controller or software that provides a timeout function to remove the signal at the end of rotation (stall).
2. Valve has a characterizing disk.

VG1000 Series Two-Way, Stainless Steel Trim, NPT End Connections Ball Valves with Non-Spring Return Electric Actuators (Continued)

Two-Way Stainless Steel Trim Ball Valves, Non-Spring Return, VA9300 Series Electric Actuators without Switches

Fluid Temperatures: -4°F to 212°F (-20°C to 100°C) Not Rated for Steam Service				AC/DC 24 V		
				On/Off	Floating	DC 0(2) to 10 V Proportional
Valve	Size, in.	Cv	Closeoff psi	VA9310-HGA-2		
VG1245DN	1-1/4	11.7 ¹	200	VG1245DN+910HGA		
VG1245DP		18.7 ¹		VG1245DP+910HGA		
VG1245DR		29.2		VG1245DR+910HGA		
VG1245EP	1-1/2	18.7 ¹	200	VG1245EP+910HGA		
VG1245ER		29.2 ¹		VG1245ER+910HGA		
VG1245ES		46.8		VG1245ES+910HGA		
VG1245FR	2	29.2 ¹	200	VG1245FR+910HGA		
VG1245FS		48.8 ¹		VG1245FS+910HGA		
VG1245FT		73.7		VG1245FT+910HGA		

Two-Way Stainless Steel Trim Ball Valves, Non-Spring Return, VA9300 Series Electric Actuators with Switches

Fluid Temperatures: -4°F to 212°F (-20°C to 100°C) Not Rated for Steam Service				AC/DC 24 V		
				On/Off	Floating	DC 0(2) to 10 V Proportional
Valve	Size, in.	Cv	Closeoff psi	VA9310-HGA-2 Actuator with M9300-2 Switch Kit ¹		
VG1245AD	1/2	1.2 ¹	200	VG1245AD+910HGC		
VG1245AE		1.9 ¹		VG1245AE+910HGC		
VG1245AF		2.9 ¹		VG1245AF+910HGC		
VG1245AG		4.7 ¹		VG1245AG+910HGC		
VG1245AL		7.4 ¹		VG1245AL+910HGC		
VG1245AN		11.7		VG1245AN+910HGC		
VG1245BG	3/4	4.7 ¹	200	VG1245BG+910HGC		
VG1245BL		7.4 ¹		VG1245BL+910HGC		
VG1245BN		11.7		VG1245BN+910HGC		
VG1245CL	1	7.4 ¹	200	VG1245CL+910HGC		
VG1245CN		11.7 ¹		VG1245CN+910HGC		
VG1245CP		18.7		VG1245CP+910HGC		
VG1245DN	1-1/4	11.7 ¹	200	VG1245DN+910HGC		
VG1245DP		18.7 ¹		VG1245DP+910HGC		
VG1245DR		29.2		VG1245DR+910HGC		
VG1245EP	1-1/2	18.7 ¹	200	VG1245EP+910HGC		
VG1245ER		29.2 ¹		VG1245ER+910HGC		
VG1245ES		46.8		VG1245ES+910HGC		
VG1245FR	2	29.2 ¹	200	VG1245FR+910HGC		
VG1245FS		46.8 ¹		VG1245FS+910HGC		
VG1245FT		73.7		VG1245FT+910HGC		

1. For field mounting order VA9310-HGA-2 and the M9300-2 Switch Kit separately.

VG1000 Series Two-Way, Stainless Steel Trim, NPT End Connections Ball Valves with Non-Spring Return Electric Actuators (Continued)

Two-Way Stainless Steel Trim Ball Valves, Non-Spring Return, VA9300 Series Electric Actuators without Switches with Optional M9000-561 Thermal Barrier

Fluid Temperatures: -22°F to 284°F (-30°C to 140°C) Water and 15 psi Saturated Steam				AC/DC 24 V		
				On/Off with Timeout	Floating with Timeout	DC 0(2) to 10 V Proportional
Valve	Size, in.	Cv	Closeoff psi	VA9310-HGA-2 with M9000-561 Thermal Barrier		
VG1245DN	1-1/4	11.7 ¹	200	VG1245DNH910HGA		
VG1245DP		18.7 ¹		VG1245DPH910HGA		
VG1245DR		29.2		VG1245DRH910HGA		
VG1245EP	1-1/2	18.7 ¹	200	VG1245EPH910HGA		
VG1245ER		29.2 ¹		VG1245ERH910HGA		
VG1245ES		46.8		VG1245ESH910HGA		
VG1245FR	2	29.2 ¹	200	VG1245FRH910HGA		
VG1245FS		48.8 ¹		VG1245FSH910HGA		
VG1245FT		73.7		VG1245FTH910HGA		

1. Valve has a characterizing disk.

Two-Way Stainless Steel Trim Ball Valves, Non-Spring Return, VA9300 Electric Actuators with Switches with Optional M9000-561 Thermal Barrier

Fluid Temperatures: -22°F to 284°F (-30°C to 140°C) Water and 15 psi Saturated Steam				AC/DC 24 V		
				On/Off	Floating	DC 0(2) to 10 V Proportional
Valve	Size, in.	Cv	Closeoff psi	VA9310-HGA-2 Actuator with M9300-2 Switch Kit with M9000-561 Thermal Barrier ¹		
VG1245AD	1/2	1.2 ²	200	VG1245ADH910HGC		
VG1245AE		1.9 ²		VG1245AEH910HGC		
VG1245AF		2.9 ²		VG1245AFH910HGC		
VG1245AG		4.7 ²		VG1245AGH910HGC		
VG1245AL		7.4 ²		VG1245ALH910HGC		
VG1245AN		11.7		VG1245ANH910HGC		
VG1245BG	3/4	4.7 ²	200	VG1245BGH910HGC		
VG1245BL		7.4 ²		VG1245BLH910HGC		
VG1245BN		11.7		VG1245BNH910HGC		
VG1245CL	1	7.4 ²	200	VG1245CLH910HGC		
VG1245CN		11.7 ²		VG1245CNH910HGC		
VG1245CP		18.7		VG1245CPH910HGC		
VG1245DN	1-1/4	11.7 ²	200	VG1245DNH910HGC		
VG1245DP		18.7 ²		VG1245DPH910HGC		
VG1245DR		29.2		VG1245DRH910HGC		
VG1245EP	1-1/2	18.7 ²	200	VG1245EPH910HGC		
VG1245ER		29.2 ²		VG1245ERH910HGC		
VG1245ES		46.8		VG1245ESH910HGC		
VG1245FR	2	29.2 ²	200	VG1245FRH910HGC		
VG1245FS		46.8 ²		VG1245FSH910HGC		
VG1245FT		73.7		VG1245FTH910HGC		

1. For field mounting order VA9310-HGA-2, M9300-2 Switch Kit, and M9000-561 Thermal Barrier separately.

2. Valve has a characterizing disk.

VG1000 Series Two-Way, Stainless Steel Trim, NPT End Connections Ball Valves with Non-Spring Return Electric Actuators (Continued)

Technical Specifications

VG1000 Series Two-Way, Stainless Steel Trim, NPT End Connections Ball Valves with Non-Spring Return Electric Actuators		
Service ¹		Hot Water, Chilled Water, 50/50 Glycol Solutions, and 15 psig (103 kPa) Saturated Steam for HVAC Systems
Fluid Temperature Limits	Water	-22°F to 284°F (-30°C to 140°C)
	Steam	15 psig (103 kPa) at 250°F (121°C)
Maximum Fluid Temperature Limits	212°F (100°C)	VA9104 Series Non-Spring Return Actuators VA9300 Series Non-Spring Return Actuators
	284°F (140°C)	VA9104 Series Non-Spring Return Actuators with M9000-561 Thermal Barrier VA9300 Series Non-Spring Return Actuators with M9000-561 Thermal Barrier
Valve Body Pressure/ Temperature Rating	Water	580 psig (4,000 kPa) at 203°F (95°C) (PN40) 464 psig (3,199 kPa) at 284°F (140°C) (PN40)
	Steam	15 psig (103 kPa) Saturated Steam
Maximum Closeoff Pressure		200 psig (1,378 kPa)
Maximum Recommended Operating Pressure Drop		50 psi (340 kPa)
Flow Characteristics	Two-Way	Equal Percentage
Rangeability ²		Greater than 500:1
Minimum Ambient Operating Temperature	-4°F (-20°C)	VA9104 Series Non-Spring Return Actuators
	-22°F (-30°C)	VA9300 Series Non-Spring Return Actuators
Maximum Ambient Operating Temperature ³	140°F (60°C)	VA9104 Series Non-Spring Return Actuators VA9300 Series Non-Spring Return Actuators
Leakage		0.01% of Maximum Flow per ANSI/FCI 70-2, Class 4
End Connections		National Pipe Thread (NPT)
Materials	Body	Forged Brass
	Ball	300 Series Stainless Steel
	Blowout-Proof Stem	300 Series Stainless Steel
	Seats	Graphite-Reinforced Polytetrafluoroethylene (PTFE) with Ethylene Propylene Diene Monomer (EPDM) O-Ring Backing
	Stem Seals	EPDM Double O-Rings
	Characterizing Disk	Amodel® AS-1145HS Polyphthalamide Resin
Compliance CRN		0C16910.5C

1. Proper water treatment is recommended; refer to the VDI 2035 Guideline.
2. Rangeability is defined as the ratio of maximum controllable flow to minimum controllable flow.
3. In steam applications, install the valve with the stem horizontal to the piping and wrap the valve and piping with insulation.

 WARNING	This product is made of copper alloy, which contains lead. The product is therefore not to be used on drinking water.
--	---

 WARNING	This product can expose you to chemicals including lead, which is known to the State of California to cause cancer, birth defects, or other reproductive harm. For more information, go to www.P65Warnings.ca.gov .
--	---

<p>WARNING: BRASS MAY CONTAIN LEAD</p> <p>To fulfill our obligations towards Article 33, in accordance to the European REACH Regulation No 1907/2006 EC, we hereby inform you that this article contains the following Substances of Very High Concern mentioned on the Candidate list:</p> <ul style="list-style-type: none"> • Lead

VG1000 Series Three-Way, Stainless Steel Trim, NPT End Connections Ball Valves with Non-Spring Return Electric Actuators

Description

VG1000 Series Ball Valves are designed to regulate the flow of hot or chilled water and, for some models, low-pressure steam in response to the demand of a controller in HVAC systems. Available in sizes 1/2 through 2 in. (DN15 through DN50), this family of two- and three-way forged brass valves is factory or field mounted to Johnson Controls® VA9104, and VA9300 Series Non-Spring Return and VA9203 and VA9208 Series Spring-Return Electric Actuators for on/off, floating, or proportional control.

Refer to the *VG1000 Series Forged Brass Ball Valves Product Bulletin (LIT-977132)* for important product application information.

Features

- Forged Brass Body — provides 580 psig static pressure rating.
- 200 psi Closeoff Pressure Rating — provides tight shutoff.

- Graphite-Reinforced Polytetrafluoroethylene (PTFE) Seats — include 15% graphite-reinforced ball seals, providing better wear resistance.
- 300 Series Stainless Steel Ball and Stem Assembly — tolerates high-temperature water or 15 psi saturated steam with fluid temperatures of -22°F to 284°F (-30°C to 140°C) or where a higher degree of corrosion protection is desired.
- 500:1 Rangeability — provides accurate control under all load conditions.



VG1000 Series Three-Way, Non-Spring Return, Stainless Steel Ball and Stem Ball Valve Assemblies

Repair Information

If the VG1000 Series Ball Valve fails to operate within its specifications, replace the valve body, actuator, or entire assembly. For replacement parts, contact the nearest Johnson Controls representative.

Selection Charts

Three-Way Stainless Steel Trim Ball Valves, Non-Spring Return, VA9104 Series Electric Actuators without Switches

Fluid Temperatures: -4°F to 212°F (-22°C to 100°C) Not Rated for Steam Service				AC 24 V		
Valve	Size, in.	Cv (Port A/B)	Closeoff psig	On/Off and/or Floating without Timeout	On/Off and/or Floating with Timeout	DC 0 to 10 V Proportional
Actuators with M3 Screw Terminals				VA9104-AGA-3S	VA9104-IGA-3S	VA9104-GGA-3S
VG1845AD	1/2	1.2/0.7 ¹	200	VG1845AD+9T4AGA	VG1845AD+9T4IGA	VG1845AD+9T4GGA
VG1845AE		1.9/1.2 ¹		VG1845AE+9T4AGA	VG1845AE+9T4IGA	VG1845AE+9T4GGA
VG1845AF		2.9/1.9 ¹		VG1845AF+9T4AGA	VG1845AF+9T4IGA	VG1845AF+9T4GGA
VG1845AG		4.7/2.9 ¹		VG1845AG+9T4AGA	VG1845AG+9T4IGA	VG1845AG+9T4GGA
VG1845AL		7.4/4.7 ¹		VG1845AL+9T4AGA	VG1845AL+9T4IGA	VG1845AL+9T4GGA
VG1845AN		11.7/5.8		VG1845AN+9T4AGA	VG1845AN+9T4IGA	VG1845AN+9T4GGA
VG1845BG	3/4	4.7/2.9 ¹	200	VG1845BG+9T4AGA	VG1845BG+9T4IGA	VG1845BG+9T4GGA
VG1845BL		7.4/4.7 ¹		VG1845BL+9T4AGA	VG1845BL+9T4IGA	VG1845BL+9T4GGA
VG1845BN		11.7/5.8		VG1845BN+9T4AGA	VG1845BN+9T4IGA	VG1845BN+9T4GGA
VG1845CL	1	7.4/4.7 ¹	200	VG1845CL+9T4AGA	VG1845CL+9T4IGA	VG1845CL+9T4GGA
VG1845CN		11.7/7.4 ¹		VG1845CN+9T4AGA	VG1845CN+9T4IGA	VG1845CN+9T4GGA
VG1845CP		18.7/9.4		VG1845CP+9T4AGA	VG1845CP+9T4IGA	VG1845CP+9T4GGA
Actuators with 120 in. (3.05 m) 18 AWG Plenum Cable				VA9104-AGA-2S	VA9104-IGA-2S	VA9104-GGA-2S
VG1845AD	1/2	1.2/0.7 ¹	200	VG1845AD+9A4AGA	VG1845AD+9A4IGA	VG1845AD+9A4GGA
VG1845AE		1.9/1.2 ¹		VG1845AE+9A4AGA	VG1845AE+9A4IGA	VG1845AE+9A4GGA
VG1845AF		2.9/1.9 ¹		VG1845AF+9A4AGA	VG1845AF+9A4IGA	VG1845AF+9A4GGA
VG1845AG		4.7/2.9 ¹		VG1845AG+9A4AGA	VG1845AG+9A4IGA	VG1845AG+9A4GGA
VG1845AL		7.4/4.7 ¹		VG1845AL+9A4AGA	VG1845AL+9A4IGA	VG1845AL+9A4GGA
VG1845AN		11.7/5.8		VG1845AN+9A4AGA	VG1845AN+9A4IGA	VG1845AN+9A4GGA
VG1845BG	3/4	4.7/2.9 ¹	200	VG1845BG+9A4AGA	VG1845BG+9A4IGA	VG1845BG+9A4GGA
VG1845BL		7.4/4.7 ¹		VG1845BL+9A4AGA	VG1845BL+9A4IGA	VG1845BL+9A4GGA
VG1845BN		11.7/5.8		VG1845BN+9A4AGA	VG1845BN+9A4IGA	VG1845BN+9A4GGA
VG1845CL	1	7.4/4.7 ¹	200	VG1845CL+9A4AGA	VG1845CL+9A4IGA	VG1845CL+9A4GGA
VG1845CN		11.7/7.4 ¹		VG1845CN+9A4AGA	VG1845CN+9A4IGA	VG1845CN+9A4GGA
VG1845CP		18.7/9.4		VG1845CP+9A4AGA	VG1845CP+9A4IGA	VG1845CP+9A4GGA

1. The for CV listed is for Port.

VG1000 Series Three-Way, Stainless Steel Trim, NPT End Connections Ball Valves with Non-Spring Return Electric Actuators (Continued)

Three-Way Stainless Steel Trim Ball Valves, Non-Spring Return, VA9104 Series Electric Actuators without Switches with M9000-561 Thermal Barrier Installed

Fluid Temperatures: -22°F to 284°F (-30°C to 140°C) Water and 15 psi Saturated Steam				AC 24 V		
Valve	Size, in.	Cv (Port A/B)	Closeoff psig	On/Off and/or Floating without Timeout ¹	On/Off and/or Floating with Timeout	DC 0 to 10 V Proportional
Actuators with M3 Screw Terminals with M9000-561 Thermal Barrier Installed				VA9104-AGA-3S	VA9104-IGA-3S	VA9104-GGA-3S
VG1845AD	1/2	1.2/0.7 ²	200	VG1845ADH9T4AGA	VG1845ADH9T4IGA	VG1845ADH9T4GGA
VG1845AE		1.9/1.2 ²		VG1845AEH9T4AGA	VG1845AEH9T4IGA	VG1845AEH9T4GGA
VG1845AF		2.9/1.9 ²		VG1845AFH9T4AGA	VG1845AFH9T4IGA	VG1845AFH9T4GGA
VG1845AG		4.7/2.9 ²		VG1845AGH9T4AGA	VG1845AGH9T4IGA	VG1845AGH9T4GGA
VG1845AL		7.4/4.7 ²		VG1845ALH9T4AGA	VG1845ALH9T4IGA	VG1845ALH9T4GGA
VG1845AN		11.7/5.8		VG1845ANH9T4AGA	VG1845ANH9T4IGA	VG1845ANH9T4GGA
VG1845BG	3/4	4.7/2.9 ²	200	VG1845BGH9T4AGA	VG1845BGH9T4IGA	VG1845BGH9T4GGA
VG1845BL		7.4/4.7 ²		VG1845BLH9T4AGA	VG1845BLH9T4IGA	VG1845BLH9T4GGA
VG1845BN		11.7/5.8		VG1845BNH9T4AGA	VG1845BNH9T4IGA	VG1845BNH9T4GGA
VG1845CL	1	7.4/4.7 ²	200	VG1845CLH9T4AGA	VG1845CLH9T4IGA	VG1845CLH9T4GGA
VG1845CN		11.7/7.4 ²		VG1845CNH9T4AGA	VG1845CNH9T4IGA	VG1845CNH9T4GGA
VG1845CP		18.7/9.4		VG1845CPH9T4AGA	VG1845CPH9T4IGA	VG1845CPH9T4GGA
Actuators with 120 in. (3.05 m) 18 AWG Plenum Cable with M9000-561 Thermal Barrier Installed				VA9104-AGA-2S	VA9104-IGA-2S	VA9104-GGA-2S
VG1845AD	1/2	1.2/0.7 ²	200	VG1845ADH9A4AGA	VG1845ADH9A4IGA	VG1845ADH9A4GGA
VG1845AE		1.9/1.2 ²		VG1845AEH9A4AGA	VG1845AEH9A4IGA	VG1845AEH9A4GGA
VG1845AF		2.9/1.9 ²		VG1845AFH9A4AGA	VG1845AFH9A4IGA	VG1845AFH9A4GGA
VG1845AG		4.7/2.9 ²		VG1845AGH9A4AGA	VG1845AGH9A4IGA	VG1845AGH9A4GGA
VG1845AL		7.4/4.7 ²		VG1845ALH9A4AGA	VG1845ALH9A4IGA	VG1845ALH9A4GGA
VG1845AN		11.7/5.8		VG1845ANH9A4AGA	VG1845ANH9A4IGA	VG1845ANH9A4GGA
VG1845BG	3/4	4.7/2.9 ²	200	VG1845BGH9A4AGA	VG1845BGH9A4IGA	VG1845BGH9A4GGA
VG1845BL		7.4/4.7 ²		VG1845BLH9A4AGA	VG1845BLH9A4IGA	VG1845BLH9A4GGA
VG1845BN		11.7/5.8		VG1845BNH9A4AGA	VG1845BNH9A4IGA	VG1845BNH9A4GGA
VG1845CL	1	7.4/4.7 ²	200	VG1845CLH9A4AGA	VG1845CLH9A4IGA	VG1845CLH9A4GGA
VG1845CN		11.7/7.4 ²		VG1845CNH9A4AGA	VG1845CNH9A4IGA	VG1845CNH9A4GGA
VG1845CP		18.7/9.4		VG1845CPH9A4AGA	VG1845CPH9A4IGA	VG1845CPH9A4GGA

1. To avoid excessive wear or drive time on the motor for the AGA models, use a controller or software that provides a timeout function to remove the signal at the end of rotation (stall).
2. Valve has a characterizing disk.

VG1000 Series Three-Way, Stainless Steel Trim, NPT End Connections Ball Valves with Non-Spring Return Electric Actuators (Continued)

Three-Way Stainless Steel Trim Ball Valves, Non-Spring Return, VA9300 Series Electric Actuators without Switches

Fluid Temperatures: -4°F to 212°F (-20°C to 100°C) Not Rated for Steam Service				AC/DC 24 V		
				On/Off	Floating	DC 0(2) to 10 V Proportional
Valve	Size, in.	Cv	Closeoff psi	VA9310-HGA-2		
VG1845DN	1-1/4	11.7 ¹	200	VG1845DN+910HGA		
VG1845DP		18.7 ¹		VG1845DP+910HGA		
VG1845DR		29.2		VG1845DR+910HGA		
VG1845EP	1-1/2	18.7 ¹	200	VG1845EP+910HGA		
VG1845ER		29.2 ¹		VG1845ER+910HGA		
VG1845ES		46.8		VG1845ES+910HGA		
VG1845FR	2	29.2 ¹	200	VG1845FR+910HGA		
VG1845FS		48.8 ¹		VG1845FS+910HGA		
VG1845FT		73.7		VG1845FT+910HGA		

1. Valve has a characterizing disk.

Three-Way Stainless Steel Trim Ball Valves, Non-Spring Return, VA9300 Series Electric Actuators with Switches

Fluid Temperatures: -4°F to 212°F (-20°C to 100°C) Not Rated for Steam Service				AC/DC 24 V		
				On/Off	Floating	DC 0(2) to 10 V Proportional
Valve	Size, in.	Cv	Closeoff psi	VA9310-HGA-2 actuator with M9300-2 Switch Kit ¹		
VG1845AD	1/2	1.2 ²	200	VG1845AD+910HGC		
VG1845AE		1.9 ²		VG1845AE+910HGC		
VG1845AF		2.9 ²		VG1845AF+910HGC		
VG1845AG		4.7 ²		VG1845AG+910HGC		
VG1845AL		7.4 ²		VG1845AL+910HGC		
VG1845AN		11.7		VG1845AN+910HGC		
VG1845BG	3/4	4.7 ²	200	VG1845BG+910HGC		
VG1845BL		7.4 ²		VG1845BL+910HGC		
VG1845BN		11.7		VG1845BN+910HGC		
VG1845CL	1	7.4 ²	200	VG1845CL+910HGC		
VG1845CN		11.7 ²		VG1845CN+910HGC		
VG1845CP		18.7		VG1845CP+910HGC		
VG1845DN	1-1/4	11.7 ²	200	VG1845DN+910HGC		
VG1845DP		18.7 ²		VG1845DP+910HGC		
VG1845DR		29.2		VG1845DR+910HGC		
VG1845EP	1-1/2	18.7 ²	200	VG1845EP+910HGC		
VG1845ER		29.2 ²		VG1845ER+910HGC		
VG1845ES		46.8		VG1845ES+910HGC		
VG1845FR	2	29.2 ²	200	VG1845FR+910HGC		
VG1845FS		46.8 ²		VG1845FS+910HGC		
VG1845FT		73.7		VG1845FT+910HGC		

1. For field mounting order VA9310-HGA-2 and the M9300-2 Switch Kit separately.

2. Valve has a characterizing disk.

VG1000 Series Three-Way, Stainless Steel Trim, NPT End Connections Ball Valves with Non-Spring Return Electric Actuators (Continued)

Three-Way Stainless Steel Trim Ball Valves, Non-Spring Return, VA9300 Series Electric Actuators without Switches with Optional M9000-561 Thermal Barrier

Fluid Temperatures: -22°F to 284°F (-30°C to 140°C) Water and 15 psi Saturated Steam				AC/DC 24 V		
				On/Off	Floating	DC 0(2) to 10 V Proportional
Valve	Size, in.	Cv	Closeoff psi	VA9310-HGA-2 with M9000-561 Thermal Barrier		
VG1845DN	1-1/4	11.7 ¹	200	VG1845DNH910HGA		
VG1845DP		18.7 ¹		VG1845DPH910HGA		
VG1845DR		29.2		VG1845DRH910HGA		
VG1845EP	1-1/2	18.7 ¹	200	VG1845EPH910HGA		
VG1845ER		29.2 ¹		VG1845ERH910HGA		
VG1845ES		46.8		VG1845ESH910HGA		
VG1845FR	2	29.2 ¹	200	VG1845FRH910HGA		
VG1845FS		48.8 ¹		VG1845FSH910HGA		
VG1845FT		73.7		VG1845FTH910HGA		

1. Valve has a characterizing disk.

Three-Way Stainless Steel Trim Ball Valves, Non-Spring Return, VA9300 Series Electric Actuators with Switches with Optional M9000-561 Thermal Barrier

Fluid Temperatures: -22°F to 284°F (-30°C to 140°C) Water and 15 psi Saturated Steam				AC/DC 24 V		
				On/Off	Floating	DC 0(2) to 10 V Proportional
Valve	Size, in.	Cv	Closeoff psi	VA9310-HGA-2 actuator with M9300-2 Switch Kit with M9000-561 Thermal Barrier ¹		
VG1845AD	1/2	1.2 ²	200	VG1845ADH910HGC		
VG1845AE		1.9 ²		VG1845AEH910HGC		
VG1845AF		2.9 ²		VG1845AFH910HGC		
VG1845AG		4.7 ²		VG1845AGH910HGC		
VG1845AL		7.4 ²		VG1845ALH910HGC		
VG1845AN		11.7		VG1845ANH910HGC		
VG1845BG	3/4	4.7 ²	200	VG1845BGH910HGC		
VG1845BL		7.4 ²		VG1845BLH910HGC		
VG1845BN		11.7		VG1845BNH910HGC		
VG1845CL	1	7.4 ²	200	VG1845CLH910HGC		
VG1845CN		11.7 ²		VG1845CNH910HGC		
VG1845CP		18.7		VG1845CPH910HGC		
VG1845DN	1-1/4	11.7 ²	200	VG1845DNH910HGC		
VG1845DP		18.7 ²		VG1845DPH910HGC		
VG1845DR		29.2		VG1845DRH910HGC		
VG1845EP	1-1/2	18.7 ²	200	VG1845EPH910HGC		
VG1845ER		29.2 ²		VG1845ERH910HGC		
VG1845ES		46.8		VG1845ESH910HGC		
VG1845FR	2	29.2 ²	200	VG1845FRH910HGC		
VG1845FS		46.8 ²		VG1845FSH910HGC		
VG1845FT		73.7		VG1845FTH910HGC		

1. For field mounting order VA9310-HGA-2, M9300-2 Switch Kit, and M9000-561 Thermal Barrier separately

2. Valve has a characterizing disk.

VG1000 Series Three-Way, Stainless Steel Trim, NPT End Connections Ball Valves with Non-Spring Return Electric Actuators (Continued)

Technical Specifications

VG1000 Series Three-Way, Stainless Steel Trim, NPT End Connections Ball Valves with Non-Spring Return Electric Actuators		
Service ¹		Hot Water, Chilled Water, 50/50 Glycol Solutions, and 15 psig (103 kPa) Saturated Steam for HVAC Systems
Fluid Temperature Limits	Water	-22°F to 284°F (-30°C to 140°C)
	Steam	15 psig (103 kPa) at 250°F (121°C)
Maximum Fluid Temperature Limits	212°F (100°C)	VA9104 Series Non-Spring Return Actuators VA9300 Series Non-Spring Return Actuators
	284°F (140°C)	VA9104 Series Non-Spring Return Actuators with M9000-561 Thermal Barrier VA9300 Series Non-Spring Return Actuators with M9000-561 Thermal Barrier
Valve Body Pressure/Temperature Rating	Water	580 psig (4,000 kPa) at 203°F (95°C) (PN40) 464 psig (3,199 kPa) at 284°F (140°C) (PN40)
	Steam	15 psig (103 kPa) Saturated Steam
Maximum Closeoff Pressure		200 psid (1,378 kPa)
Maximum Recommended Operating Pressure Drop		50 psid (340 kPa)
Flow Characteristics	Three-Way	Equal Percentage Flow Characteristics of In-Line Port A (Coil) and Linear Flow Characteristics of Angle Port B (Bypass)
Rangeability ²		Greater than 500:1
Minimum Ambient Operating Temperature	-4°F (-20°C)	VA9104 Series Non-Spring Return Actuators
	-22°F (-30°C)	VA9300 Series Non-Spring Return Actuators
Maximum Ambient Operating Temperature ³	140°F (60°C)	VA9104 Series Non-Spring Return Actuators VA9300 Series Non-Spring Return Actuators
Leakage		0.01% of Maximum Flow per ANSI/FCI 70-2, Class 4
End Connections		National Pipe Thread (NPT)
Materials	Body	Forged Brass
	Ball	300 Series Stainless Steel
	Blowout-Proof Stem	300 Series Stainless Steel
	Seats	Graphite-Reinforced Polytetrafluoroethylene (PTFE) with Ethylene Propylene Diene Monomer (EPDM) O-Ring Backing
	Stem Seals	EPDM Double O-Rings
	Characterizing Disk	Amodel® AS-1145HS Polyphthalamide Resin
Compliance CRN		0C16910.5C

1. Proper water treatment is recommended; refer to the VDI 2035 Guideline.
2. Rangeability is defined as the ratio of maximum controllable flow to minimum controllable flow.
3. In steam applications, install the valve with the stem horizontal to the piping and wrap the valve and piping with insulation.



WARNING This product is made of copper alloy, which contains lead. The product is therefore not to be used on drinking water.



WARNING This product can expose you to chemicals including lead, which is known to the State of California to cause cancer, birth defects, or other reproductive harm. For more information, go to www.P65Warnings.ca.gov.

WARNING: BRASS MAY CONTAIN LEAD

To fulfill our obligations towards Article 33, in accordance to the European REACH Regulation No 1907/2006 EC, we hereby inform you that this article contains the following Substances of Very High Concern mentioned on the Candidate list:

- Lead

VG1000 Series Two-Way, Stainless Steel Trim, NPT End Connections Ball Valves with Spring-Return Electric Actuators with Switches

Description

VG1000 Series Ball Valves are designed to regulate the flow of hot or chilled water and, for some models, low-pressure steam in response to the demand of a controller in HVAC systems. Available in sizes 1/2 through 2 in. (DN15 through DN50), this family of two- and three-way forged brass valves is factory or field mounted to Johnson Controls® VA9104, VA9109, and M9100 Series Non-Spring Return and VA9203 and VA9208 Series Spring Return Electric Actuators for on/off, floating, or proportional control.

Refer to the *VG1000 Series Forged Brass Ball Valves Product Bulletin (LIT-977132)* for important product application information.

Features

- Forged Brass Body — provides 580 psig static pressure rating.
- Graphite-Reinforced Polytetrafluoroethylene (PTFE) Seats — include 15% graphite-reinforced ball seals, providing better wear resistance.
- 500:1 Rangeability — provides accurate control under all load conditions.
- Maintenance-Free Design — performs without failure in excess of 200,000 full stroke cycles in iron-oxide contaminated water.



Repair Information

If the VG1000 Series Ball Valve fails to operate within its specifications, replace the valve body, actuator, or entire assembly. For replacement parts, contact the nearest Johnson Controls representative.

VG1000 Series Two-Way, Spring-Return, Stainless Steel Ball and Stem Ball Valve Assemblies with End Switches

Selection Charts

Two-Way — Spring Return Valve Open — Normally Open with Switches (Not Rated for Steam Service)

Fluid Temperatures: -22°F to 212°F (-30°C to 100°C) Not Rated for Steam Service				AC 24 V			AC 85–264 V (VA9203) AC 120 V (VA9208)
Valve	Size, in.	Cv	Closeoff psig	Floating	DC 0 to 10 V Proportional	On/Off	On/Off
Spring Return Open — Valve Normally Open — Actuators with One Switch							
				VA9203-AGB-2Z	VA9203-GGB-2Z	VA9203-BGB-2	VA9203-BUB-2
VG1245AD	1/2	1.2 ¹	200	VG1245AD+923AGB	VG1245AD+923GGB	VG1245AD+923BGB	VG1245AD+923BUB
VG1245AE		1.9 ¹		VG1245AE+923AGB	VG1245AE+923GGB	VG1245AE+923BGB	VG1245AE+923BUB
VG1245AF		2.9 ¹		VG1245AF+923AGB	VG1245AF+923GGB	VG1245AF+923BGB	VG1245AF+923BUB
VG1245AG		4.7 ¹		VG1245AG+923AGB	VG1245AG+923GGB	VG1245AG+923BGB	VG1245AG+923BUB
VG1245AL		7.4 ¹		VG1245AL+923AGB	VG1245AL+923GGB	VG1245AL+923BGB	VG1245AL+923BUB
VG1245AN		11.7		VG1245AN+923AGB	VG1245AN+923GGB	VG1245AN+923BGB	VG1245AN+923BUB
VG1245BG	3/4	4.7 ¹	200	VG1245BG+923AGB	VG1245BG+923GGB	VG1245BG+923BGB	VG1245BG+923BUB
VG1245BL		7.4 ¹		VG1245BL+923AGB	VG1245BL+923GGB	VG1245BL+923BGB	VG1245BL+923BUB
VG1245BN		11.7		VG1245BN+923AGB	VG1245BN+923GGB	VG1245BN+923BGB	VG1245BN+923BUB
VG1245CL	1	7.4 ¹	200	VG1245CL+923AGB	VG1245CL+923GGB	VG1245CL+923BGB	VG1245CL+923BUB
VG1245CN		11.7 ¹		VG1245CN+923AGB	VG1245CN+923GGB	VG1245CN+923BGB	VG1245CN+923BUB
VG1245CP		18.7		VG1245CP+923AGB	VG1245CP+923GGB	VG1245CP+923BGB	VG1245CP+923BUB
Spring Return Open — Valve Normally Open — Actuators with Two Switches							
				VA9208-AGC-3	VA9208-GGC-3	VA9208-BGC-3	VA9208-BAC-3
VG1245DN	1-1/4	11.7 ¹	200	VG1245DN+938AGC	VG1245DN+938GGC	VG1245DN+938BGC	VG1245DN+938BAC
VG1245DP		18.7 ¹		VG1245DP+938AGC	VG1245DP+938GGC	VG1245DP+938BGC	VG1245DP+938BAC
VG1245DR		29.2		VG1245DR+938AGC	VG1245DR+938GGC	VG1245DR+938BGC	VG1245DR+938BAC
VG1245EP	1-1/2	18.7 ¹	200	VG1245EP+938AGC	VG1245EP+938GGC	VG1245EP+938BGC	VG1245EP+938BAC
VG1245ER		29.2 ¹		VG1245ER+938AGC	VG1245ER+938GGC	VG1245ER+938BGC	VG1245ER+938BAC
VG1245ES		46.8		VG1245ES+938AGC	VG1245ES+938GGC	VG1245ES+938BGC	VG1245ES+938BAC
VG1245FR	2	29.2 ¹	200	VG1245FR+938AGC	VG1245FR+938GGC	VG1245FR+938BGC	VG1245FR+938BAC
VG1245FS		46.8 ¹		VG1245FS+938AGC	VG1245FS+938GGC	VG1245FS+938BGC	VG1245FS+938BAC
VG1245FT		73.7		VG1245FT+938AGC	VG1245FT+938GGC	VG1245FT+938BGC	VG1245FT+938BAC

1. Valve has a characterizing disk.

VG1000 Series Two-Way, Stainless Steel Trim, NPT End Connections Ball Valves with Spring-Return Electric Actuators with Switches (Continued)

Two-Way — Spring Return Closed — Valve Normally Closed

Fluid Temperatures: -22°F to 212°F (-30°C to 100°C) Not Rated for Steam Service				AC 24 V			AC 85–264 V (VA9203) AC 120 V (VA9208)
Valve	Size, in.	Cv	Closeoff psig	Floating	DC 0 to 10 V Proportional	On/Off	On/Off
Spring Return Closed — Valve Normally Closed — Actuators with One Switch							
				VA9203-AGB-2Z	VA9203-GGB-2Z	VA9203-BGB-2	VA9203-BUB-2
VG1245AD	1/2	1.2 ¹	200	VG1245AD+943AGB	VG1245AD+943GGB	VG1245AD+943BGB	VG1245AD+943BUB
VG1245AE		1.9 ¹		VG1245AE+943AGB	VG1245AE+943GGB	VG1245AE+943BGB	VG1245AE+943BUB
VG1245AF		2.9 ¹		VG1245AF+943AGB	VG1245AF+943GGB	VG1245AF+943BGB	VG1245AF+943BUB
VG1245AG		4.7 ¹		VG1245AG+943AGB	VG1245AG+943GGB	VG1245AG+943BGB	VG1245AG+943BUB
VG1245AL		7.4 ¹		VG1245AL+943AGB	VG1245AL+943GGB	VG1245AL+943BGB	VG1245AL+943BUB
VG1245AN		11.7		VG1245AN+943AGB	VG1245AN+943GGB	VG1245AN+943BGB	VG1245AN+943BUB
VG1245BG	3/4	4.7 ¹	200	VG1245BG+943AGB	VG1245BG+943GGB	VG1245BG+943BGB	VG1245BG+943BUB
VG1245BL		7.4 ¹		VG1245BL+943AGB	VG1245BL+943GGB	VG1245BL+943BGB	VG1245BL+943BUB
VG1245BN		11.7		VG1245BN+943AGB	VG1245BN+943GGB	VG1245BN+943BGB	VG1245BN+943BUB
VG1245CL	1	7.4 ¹	200	VG1245CL+943AGB	VG1245CL+943GGB	VG1245CL+943BGB	VG1245CL+943BUB
VG1245CN		11.7 ¹		VG1245CN+943AGB	VG1245CN+943GGB	VG1245CN+943BGB	VG1245CN+943BUB
VG1245CP		18.7		VG1245CP+943AGB	VG1245CP+943GGB	VG1245CP+943BGB	VG1245CP+943BUB
Spring Return Closed — Valve Normally Closed — Actuators with Two Switches							
				VA9208-AGC-3	VA9208-GGC-3	VA9208-BGC-3	VA9208-BAC-3
VG1245DN	1-1/4	11.7 ¹	200	VG1245DN+958AGC	VG1245DN+958GGC	VG1245DN+958BGC	VG1245DN+958BAC
VG1245DP		18.7 ¹		VG1245DP+958AGC	VG1245DP+958GGC	VG1245DP+958BGC	VG1245DP+958BAC
VG1245DR		29.2		VG1245DR+958AGC	VG1245DR+958GGC	VG1245DR+958BGC	VG1245DR+958BAC
VG1245EP	1-1/2	18.7 ¹	200	VG1245EP+958AGC	VG1245EP+958GGC	VG1245EP+958BGC	VG1245EP+958BAC
VG1245ER		29.2 ¹		VG1245ER+958AGC	VG1245ER+958GGC	VG1245ER+958BGC	VG1245ER+958BAC
VG1245ES		46.8		VG1245ES+958AGC	VG1245ES+958GGC	VG1245ES+958BGC	VG1245ES+958BAC
VG1245FR	2	29.2 ¹	200	VG1245FR+958AGC	VG1245FR+958GGC	VG1245FR+958BGC	VG1245FR+958BAC
VG1245FS		46.8 ¹		VG1245FS+958AGC	VG1245FS+958GGC	VG1245FS+958BGC	VG1245FS+958BAC
VG1245FT		73.7		VG1245FT+958AGC	VG1245FT+958GGC	VG1245FT+958BGC	VG1245FT+958BAC

1. Valve has a characterizing disk.

VG1000 Series Two-Way, Stainless Steel Trim, NPT End Connections Ball Valves with Spring-Return Electric Actuators with Switches (Continued)

Valve Assemblies with M9000-561 Thermal Barrier Installed — Rated for High-Temperature Fluid Service, Two-Way — Spring Return — With End Switches

Fluid Temperatures: -22°F to 284°F (-30°C to 140°C), 15 psi Steam				AC 24 V			AC 85–264 V (VA9203) AC 120 V (VA9208)
Valve	Size, in.	Cv	Closeoff psig	Floating	DC 0 to 10 V Proportional	On/Off	On/Off
Spring Return Open — Valve Normally Open — Actuators with One Switch							
				VA9203-AGB-2Z	VA9203-GGB-2Z	VA9203-BGB-2	VA9203-BUB-2
VG1245AD	1/2	1.2 ¹	200	VG1245ADH923AGB	VG1245ADH923GGB	VG1245ADH923BGB	VG1245ADH923BUB
VG1245AE		1.9 ¹		VG1245AEH923AGB	VG1245AEH923GGB	VG1245AEH923BGB	VG1245AEH923BUB
VG1245AF		2.9 ¹		VG1245AFH923AGB	VG1245AFH923GGB	VG1245AFH923BGB	VG1245AFH923BUB
VG1245AG		4.7 ¹		VG1245AGH923AGB	VG1245AGH923GGB	VG1245AGH923BGB	VG1245AGH923BUB
VG1245AL		7.4 ¹		VG1245ALH923AGB	VG1245ALH923GGB	VG1245ALH923BGB	VG1245ALH923BUB
VG1245AN		11.7		VG1245ANH923AGB	VG1245ANH923GGB	VG1245ANH923BGB	VG1245ANH923BUB
VG1245BG	3/4	4.7 ¹	200	VG1245BGH923AGB	VG1245BGH923GGB	VG1245BGH923BGB	VG1245BGH923BUB
VG1245BL		7.4 ¹		VG1245BLH923AGB	VG1245BLH923GGB	VG1245BLH923BGB	VG1245BLH923BUB
VG1245BN		11.7		VG1245BNH923AGB	VG1245BNH923GGB	VG1245BNH923BGB	VG1245BNH923BUB
VG1245CL	1	7.4 ¹	200	VG1245CLH923AGB	VG1245CLH923GGB	VG1245CLH923BGB	VG1245CLH923BUB
VG1245CN		11.7 ¹		VG1245CNH923AGB	VG1245CNH923GGB	VG1245CNH923BGB	VG1245CNH923BUB
VG1245CP		18.7		VG1245CPH923AGB	VG1245CPH923GGB	VG1245CPH923BGB	VG1245CPH923BUB
Spring Return Open — Valve Normally Open — Actuators with Two Switches							
				VA9208-AGC-3	VA9208-GGC-3	VA9208-BGC-3	VA9208-BAC-3
VG1245DN	1-1/4	11.7 ¹	200	VG1245DNH938AGC	VG1245DNH938GGC	VG1245DNH938BGC	VG1245DNH938BAC
VG1245DP		18.7 ¹		VG1245DPH938AGC	VG1245DPH938GGC	VG1245DPH938BGC	VG1245DPH938BAC
VG1245DR		29.2		VG1245DRH938AGC	VG1245DRH938GGC	VG1245DRH938BGC	VG1245DRH938BAC
VG1245EP	1-1/2	18.7 ¹	200	VG1245EPH938AGC	VG1245EPH938GGC	VG1245EPH938BGC	VG1245EPH938BAC
VG1245ER		29.2 ¹		VG1245ERH938AGC	VG1245ERH938GGC	VG1245ERH938BGC	VG1245ERH938BAC
VG1245ES		46.8		VG1245ESH938AGC	VG1245ESH938GGC	VG1245ESH938BGC	VG1245ESH938BAC
VG1245FR	2	29.2 ¹	200	VG1245FRH938AGC	VG1245FRH938GGC	VG1245FRH938BGC	VG1245FRH938BAC
VG1245FS		46.8 ¹		VG1245FSH938AGC	VG1245FSH938GGC	VG1245FSH938BGC	VG1245FSH938BAC
VG1245FT		73.7		VG1245FTH938AGC	VG1245FTH938GGC	VG1245FTH938BGC	VG1245FTH938BAC
Spring Return Closed — Valve Normally Closed — Actuators with One Switch							
				VA9203-AGB-2Z	VA9203-GGB-2Z	VA9203-BGB-2	VA9203-BUB-2
VG1245AD	1/2	1.2 ¹	200	VG1245ADH943AGB	VG1245ADH943GGB	VG1245ADH943BGB	VG1245ADH943BUB
VG1245AE		1.9 ¹		VG1245AEH943AGB	VG1245AEH943GGB	VG1245AEH943BGB	VG1245AEH943BUB
VG1245AF		2.9 ¹		VG1245AFH943AGB	VG1245AFH943GGB	VG1245AFH943BGB	VG1245AFH943BUB
VG1245AG		4.7 ¹		VG1245AGH943AGB	VG1245AGH943GGB	VG1245AGH943BGB	VG1245AGH943BUB
VG1245AL		7.4 ¹		VG1245ALH943AGB	VG1245ALH943GGB	VG1245ALH943BGB	VG1245ALH943BUB
VG1245AN		11.7		VG1245ANH943AGB	VG1245ANH943GGB	VG1245ANH943BGB	VG1245ANH943BUB
VG1245BG	3/4	4.7 ¹	200	VG1245BGH943AGB	VG1245BGH943GGB	VG1245BGH943BGB	VG1245BGH943BUB
VG1245BL		7.4 ¹		VG1245BLH943AGB	VG1245BLH943GGB	VG1245BLH943BGB	VG1245BLH943BUB
VG1245BN		11.7		VG1245BNH943AGB	VG1245BNH943GGB	VG1245BNH943BGB	VG1245BNH943BUB
VG1245CL	1	7.4 ¹	200	VG1245CLH943AGB	VG1245CLH943GGB	VG1245CLH943BGB	VG1245CLH943BUB
VG1245CN		11.7 ¹		VG1245CNH943AGB	VG1245CNH943GGB	VG1245CNH943BGB	VG1245CNH943BUB
VG1245CP		18.7		VG1245CPH943AGB	VG1245CPH943GGB	VG1245CPH943BGB	VG1245CPH943BUB
Spring Return Closed — Valve Normally Closed — Actuators with Two Switches							
				VA9208-AGC-3	VA9208-GGC-3	VA9208-BGC-3	VA9208-BAC-3
VG1245DN	1-1/4	11.7 ¹	200	VG1245DNH958AGC	VG1245DNH958GGC	VG1245DNH958BGC	VG1245DNH958BAC
VG1245DP		18.7 ¹		VG1245DPH958AGC	VG1245DPH958GGC	VG1245DPH958BGC	VG1245DPH958BAC
VG1245DR		29.2		VG1245DRH958AGC	VG1245DRH958GGC	VG1245DRH958BGC	VG1245DRH958BAC
VG1245EP	1-1/2	18.7 ¹	200	VG1245EPH958AGC	VG1245EPH958GGC	VG1245EPH958BGC	VG1245EPH958BAC
VG1245ER		29.2 ¹		VG1245ERH958AGC	VG1245ERH958GGC	VG1245ERH958BGC	VG1245ERH958BAC
VG1245ES		46.8		VG1245ESH958AGC	VG1245ESH958GGC	VG1245ESH958BGC	VG1245ESH958BAC
VG1245FR	2	29.2 ¹	200	VG1245FRH958AGC	VG1245FRH958GGC	VG1245FRH958BGC	VG1245FRH958BAC
VG1245FS		46.8 ¹		VG1245FSH958AGC	VG1245FSH958GGC	VG1245FSH958BGC	VG1245FSH958BAC
VG1245FT		73.7		VG1245FTH958AGC	VG1245FTH958GGC	VG1245FTH958BGC	VG1245FTH958BAC

1. Valve has a characterizing disk.

The performance specifications are nominal and conform to acceptable industry standards. For applications at conditions beyond these specifications, consult the local Johnson Controls office. Johnson Controls shall not be liable for damages resulting from misapplication or misuse of its products. © 2019 Johnson Controls. www.johnsoncontrols.com

VG1000 Series Two-Way, Stainless Steel Trim, NPT End Connections Ball Valves with Spring-Return Electric Actuators with Switches (Continued)

Technical Specifications

VG1000 Series Two-Way, Stainless Steel Trim, NPT End Connections Ball Valves with Spring-Return Electric Actuators with Switches		
Service¹		Hot Water, Chilled Water, 50/50 Glycol Solutions, and 15 psig (103 kPa) Saturated Steam for HVAC Systems (Select Models)
Fluid Temperature Limits	Water	-22°F to 284°F (-30°C to 140°C)
	Steam	15 psig (103 kPa) at 250°F (121°C)
Maximum Actuator Fluid Temperature Limit	212°F (100°C)	VA9203 VA9208
	284°F (140°C)	VA9203 with M9000-561 Thermal Barrier VA9208 with M9000-561 Thermal Barrier
Valve Body Pressure Rating	Water	580 psig (4,000 kPa) at 203°F (95°C) 464 psig (3,199 kPa) at 284°F (140°C) (PN40)
	Steam	15 psig (103 kPa) Saturated Steam (Only with VA9203 or VA9208 Series Actuator with M900-561 Thermal Barrier)
Maximum Closeoff Pressure		200 psid (1,378 kPa)
Maximum Recommended Operating Pressure Drop		50 psid (340 kPa)
Flow Characteristics	Two-Way	Equal Percentage
Rangeability²		Greater than 500:1
Minimum Ambient Operating Temperature	-22°F (-30°C)	VA9203 Series Spring-Return Actuators
	-40°F (-40°C)	VA9208 Series Spring-Return Actuators
Maximum Ambient Operating Temperature³ (Limited by the Actuator)	Direct Mount	140°F (60°C): VA9203 or VA9208 Series Spring-Return Actuators
Leakage		0.01% of Maximum Flow per ANSI/FCI 70-2, Class 4
		1% of Maximum Flow for Three-Way Bypass Port
End Connections		National Pipe Thread (NPT)
Materials	Body	Forged Brass
	Ball	300 Series Stainless Steel
	Blowout-Proof Stem	300 Series Stainless Steel
	Seats	Graphite-Reinforced PTFE with Ethylene Propylene Diene Monomer (EPDM) O-Ring Backing
	Stem Seals	EPDM Double O-Rings
	Characterizing Disk	Amodel® AS-1145HS Polyphthalamide Resin
Compliance CRN		0C16910.5C

1. Proper water treatment is recommended; refer to the VDI 2035 Guideline.
2. Rangeability is defined as the ratio of maximum controllable flow to minimum controllable flow.
3. In steam applications, install the valve with the stem horizontal to the piping and wrap the valve and piping with insulation.



WARNING This product is made of copper alloy, which contains lead. The product is therefore not to be used on drinking water.



WARNING This product can expose you to chemicals including lead, which is known to the State of California to cause cancer, birth defects, or other reproductive harm. For more information, go to www.P65Warnings.ca.gov.

WARNING: BRASS MAY CONTAIN LEAD

To fulfill our obligations towards Article 33, in accordance to the European REACH Regulation No 1907/2006 EC, we hereby inform you that this article contains the following Substances of Very High Concern mentioned on the Candidate list:

- Lead

VG1000 Series Three-Way, Stainless Steel Trim, NPT End Connections Ball Valves with Spring-Return Electric Actuators without Switches

Description

VG1000 Series Ball Valves are designed to regulate the flow of hot or chilled water and, for some models, low-pressure steam in response to the demand of a controller in HVAC systems. Available in sizes 1/2 through 2 in. (DN15 through DN50), this family of two- and three-way forged brass valves is factory or field mounted to Johnson Controls® VA9104, M9106, M9109, and M9100 Series Non-Spring-Return and VA9203 and VA9208 Series Spring Return Electric Actuators for on/off, floating, or proportional control.

Refer to the *VG1000 Series Forged Brass Ball Valves Product Bulletin (LIT-977132)* for important product application information.

Features

- Forged Brass Body — provides 580 psig static pressure rating.
- 300 Series Stainless Steel Ball and Stem Assembly — tolerates high-temperature water or 15 psi saturated steam with fluid temperatures of -22°F to 284°F (-30°C to 140°C) or where a higher degree of corrosion protection is desired.
- 500:1 Rangeability — provides accurate control under all load conditions.
- Maintenance-Free Design — performs without failure in excess of 200,000 full stroke cycles in iron-oxide contaminated water.



Repair Information

If the VG1000 Series Ball Valve fails to operate within its specifications, replace the valve body, actuator, or entire assembly. For replacement parts, contact the nearest Johnson Controls representative.

VG1000 Series Three-Way, Spring-Return, Stainless Steel Ball and Stem Ball Valve Assemblies without End Switches

Selection Charts

Three-Way — Spring Return without Switches (Not Rated for Steam Service) (Part 1 of 2)

Fluid Temperatures: -22°F to 212°F (-30°C to 100°C) Not Rated for Steam Service				AC 24 V			AC 85–264 V (VA9203) AC 120 V (VA9208)
Valve	Size, in.	Cv (Port A/B)	Closeoff psig	Floating	0 to 10 VDC Proportional	On/Off	On/Off
				Spring Return Port A Open — Valve Spring Return Counterclockwise			
				VA9203-AGA-2Z	VA9203-GGA-2Z	VA9203-BGA-2	VA9203-BUA-2
VG1845AD	1/2	1.2 ¹	200	VG1845AD+923AGA	VG1845AD+923GGA	VG1845AD+923BGA	VG1845AD+923BUA
VG1845AE		1.9 ¹		VG1845AE+923AGA	VG1845AE+923GGA	VG1845AE+923BGA	VG1845AE+923BUA
VG1845AF		2.9 ¹		VG1845AF+923AGA	VG1845AF+923GGA	VG1845AF+923BGA	VG1845AF+923BUA
VG1845AG		4.7 ¹		VG1845AG+923AGA	VG1845AG+923GGA	VG1845AG+923BGA	VG1845AG+923BUA
VG1845AL		7.4 ¹		VG1845AL+923AGA	VG1845AL+923GGA	VG1845AL+923BGA	VG1845AL+923BUA
VG1845AN		11.7		VG1845AN+923AGA	VG1845AN+923GGA	VG1845AN+923BGA	VG1845AN+923BUA
VG1845BG	3/4	4.7 ¹	200	VG1845BG+923AGA	VG1845BG+923GGA	VG1845BG+923BGA	VG1845BG+923BUA
VG1845BL		7.4 ¹		VG1845BL+923AGA	VG1845BL+923GGA	VG1845BL+923BGA	VG1845BL+923BUA
VG1845BN		11.7		VG1845BN+923AGA	VG1845BN+923GGA	VG1845BN+923BGA	VG1845BN+923BUA
VG1845CL	1	7.4 ¹	200	VG1845CL+923AGA	VG1845CL+923GGA	VG1845CL+923BGA	VG1845CL+923BUA
VG1845CN		11.7 ¹		VG1845CN+923AGA	VG1845CN+923GGA	VG1845CN+923BGA	VG1845CN+923BUA
VG1845CP		18.7		VG1845CP+923AGA	VG1845CP+923GGA	VG1845CP+923BGA	VG1845CP+923BUA
				Spring Return Port A Open — Valve Spring Return Counterclockwise			
				VA9208-AGA-2	VA9208-GGA-2	VA9208-BGA-3	VA9208-BAA-3
VG1845DN	1-1/4	11.7 ¹	200	VG1845DN+928AGA	VG1845DN+928GGA	VG1845DN+938BGA	VG1845DN+938BAA
VG1845DP		18.7 ¹		VG1845DP+928AGA	VG1845DP+928GGA	VG1845DP+938BGA	VG1845DP+938BAA
VG1845DR		29.2		VG1845DR+928AGA	VG1845DR+928GGA	VG1845DR+938BGA	VG1845DR+938BAA
VG1845EP	1-1/2	18.7 ¹	200	VG1845EP+928AGA	VG1845EP+928GGA	VG1845EP+938BGA	VG1845EP+938BAA
VG1845ER		29.2 ¹		VG1845ER+928AGA	VG1845ER+928GGA	VG1845ER+938BGA	VG1845ER+938BAA
VG1845ES		46.8		VG1845ES+928AGA	VG1845ES+928GGA	VG1845ES+938BGA	VG1845ES+938BAA

The performance specifications are nominal and conform to acceptable industry standards. For applications at conditions beyond these specifications, consult the local Johnson Controls office. Johnson Controls shall not be liable for damages resulting from misapplication or misuse of its products. © 2019 Johnson Controls. www.johnsoncontrols.com

VG1000 Series Three-Way, Stainless Steel Trim, NPT End Connections Ball Valves with Spring-Return Electric Actuators without Switches (Continued)

Three-Way — Spring Return without Switches (Not Rated for Steam Service) (Part 2 of 2)

Fluid Temperatures: -22°F to 212°F (-30°C to 100°C) Not Rated for Steam Service				AC 24 V			AC 85–264 V (VA9203) AC 120 V (VA9208)
Valve	Size, in.	Cv (Port A/B)	Closeoff psig	Floating	0 to 10 VDC Proportional	On/Off	On/Off
VG1845FR	2	29.2 ¹	200	VG1845FR+928AGA	VG1845FR+928GGA	VG1845FR+938BGA	VG1845FR+938BAA
VG1845FS		46.8 ¹		VG1845FS+928AGA	VG1845FS+928GGA	VG1845FS+938BGA	VG1845FS+938BAA
VG1845FT		73.7		VG1845FT+928AGA	VG1845FT+928GGA	VG1845FT+938BGA	VG1845FT+938BAA
				Spring Return Port A Closed — Valve Spring Return Clockwise			
				VA9203-AGA-2Z	VA9203-GGA-2Z	VA9203-BGA-2	VA9203-BUA-2
VG1845AD	1/2	1.2 ¹	200	VG1845AD+943AGA	VG1845AD+943GGA	VG1845AD+943BGA	VG1845AD+943BUA
VG1845AE		1.9 ¹		VG1845AE+943AGA	VG1845AE+943GGA	VG1845AE+943BGA	VG1845AE+943BUA
VG1845AF		2.9 ¹		VG1845AF+943AGA	VG1845AF+943GGA	VG1845AF+943BGA	VG1845AF+943BUA
VG1845AG		4.7 ¹		VG1845AG+943AGA	VG1845AG+943GGA	VG1845AG+943BGA	VG1845AG+943BUA
VG1845AL		7.4 ¹		VG1845AL+943AGA	VG1845AL+943GGA	VG1845AL+943BGA	VG1845AL+943BUA
VG1845AN		11.7		VG1845AN+943AGA	VG1845AN+943GGA	VG1845AN+943BGA	VG1845AN+943BUA
VG1845BG	3/4	4.7 ¹	200	VG1845BG+943AGA	VG1845BG+943GGA	VG1845BG+943BGA	VG1845BG+943BUA
VG1845BL		7.4 ¹		VG1845BL+943AGA	VG1845BL+943GGA	VG1845BL+943BGA	VG1845BL+943BUA
VG1845BN		11.7		VG1845BN+943AGA	VG1845BN+943GGA	VG1845BN+943BGA	VG1845BN+943BUA
VG1845CL	1	7.4 ¹	200	VG1845CL+943AGA	VG1845CL+943GGA	VG1845CL+943BGA	VG1845CL+943BUA
VG1845CN		11.7 ¹		VG1845CN+943AGA	VG1845CN+943GGA	VG1845CN+943BGA	VG1845CN+943BUA
VG1845CP		18.7		VG1845CP+943AGA	VG1845CP+943GGA	VG1845CP+943BGA	VG1845CP+943BUA
				Spring Return Port A Closed — Valve Spring Return Clockwise			
				VA9208-AGA-2	VA9208-GGA-2	VA9208-BGA-3	VA9208-BAA-3
VG1845DN	1-1/4	11.7 ¹	200	VG1845DN+948AGA	VG1845DN+948GGA	VG1845DN+958BGA	VG1845DN+958BAA
VG1845DP		18.7 ¹		VG1845DP+948AGA	VG1845DP+948GGA	VG1845DP+958BGA	VG1845DP+958BAA
VG1845DR		29.2		VG1845DR+948AGA	VG1845DR+948GGA	VG1845DR+958BGA	VG1845DR+958BAA
VG1845EP	1-1/2	18.7 ¹	200	VG1845EP+948AGA	VG1845EP+948GGA	VG1845EP+958BGA	VG1845EP+958BAA
VG1845ER		29.2 ¹		VG1845ER+948AGA	VG1845ER+948GGA	VG1845ER+958BGA	VG1845ER+958BAA
VG1845ES		46.8		VG1845ES+948AGA	VG1845ES+948GGA	VG1845ES+958BGA	VG1845ES+958BAA
VG1845FR	2	29.2 ¹	200	VG1845FR+948AGA	VG1845FR+948GGA	VG1845FR+958BGA	VG1845FR+958BAA
VG1845FS		46.8 ¹		VG1845FS+948AGA	VG1845FS+948GGA	VG1845FS+958BGA	VG1845FS+958BAA
VG1845FT		73.7		VG1845FT+948AGA	VG1845FT+948GGA	VG1845FT+958BGA	VG1845FT+958BAA

1. Valve has a characterizing disk.

Valve Assemblies with M9000-561 Thermal Barrier Installed — Rated for High-Temperature Fluid Service, Three-Way — Spring Return without Switches (Part 1 of 2)

Fluid Temperatures: -22°F to 284°F (-30°C to 140°C) Water and 15 psi Steam				AC 24 V			AC 85–264 V (VA9203) AC 120 V (VA9208)
Valve	Size, in.	Cv (Port A/B)	Closeoff psig	Floating	0 to 10 VDC Proportional	On/Off	On/Off
				Spring Return Port A Open — Valve Spring Return Counterclockwise			
				VA9203-AGA-2Z	VA9203-GGA-2Z	VA9203-BGA-2	VA9203-BUA-2
VG1845AD	1/2	1.2 ¹	200	VG1845ADH923AGA	VG1845ADH923GGA	VG1845ADH923BGA	VG1845ADH923BUA
VG1845AE		1.9 ¹		VG1845AEH923AGA	VG1845AEH923GGA	VG1845AEH923BGA	VG1845AEH923BUA
VG1845AF		2.9 ¹		VG1845AFH923AGA	VG1845AFH923GGA	VG1845AFH923BGA	VG1845AFH923BUA
VG1845AG		4.7 ¹		VG1845AGH923AGA	VG1845AGH923GGA	VG1845AGH923BGA	VG1845AGH923BUA
VG1845AL		7.4 ¹		VG1845ALH923AGA	VG1845ALH923GGA	VG1845ALH923BGA	VG1845ALH923BUA
VG1845AN		11.7		VG1845ANH923AGA	VG1845ANH923GGA	VG1845ANH923BGA	VG1845ANH923BUA

VG1000 Series Three-Way, Stainless Steel Trim, NPT End Connections Ball Valves with Spring-Return Electric Actuators without Switches (Continued)

Valve Assemblies with M9000-561 Thermal Barrier Installed — Rated for High-Temperature Fluid Service, Three-Way — Spring Return without Switches (Part 2 of 2)

Fluid Temperatures: -22°F to 284°F (-30°C to 140°C) Water and 15 psi Steam				AC 24 V			AC 85–264 V (VA9203) AC 120 V (VA9208)
Valve	Size, in.	Cv (Port A/B)	Closeoff psig	Floating	0 to 10 VDC Proportional	On/Off	On/Off
VG1845BG	3/4	4.7 ¹	200	VG1845BGH923AGA	VG1845BGH923GGA	VG1845BGH923BGA	VG1845BGH923BUA
VG1845BL		7.4 ¹		VG1845BLH923AGA	VG1845BLH923GGA	VG1845BLH923BGA	VG1845BLH923BUA
VG1845BN		11.7		VG1845BNH923AGA	VG1845BNH923GGA	VG1845BNH923BGA	VG1845BNH923BUA
VG1845CL	1	7.4 ¹	200	VG1845CLH923AGA	VG1845CLH923GGA	VG1845CLH923BGA	VG1845CLH923BUA
VG1845CN		11.7 ¹		VG1845CNH923AGA	VG1845CNH923GGA	VG1845CNH923BGA	VG1845CNH923BUA
VG1845CP		18.7		VG1845CPH923AGA	VG1845CPH923GGA	VG1845CPH923BGA	VG1845CPH923BUA
				Spring Return Port A Open — Valve Spring Return Counterclockwise			
				VA9208-AGA-2	VA9208-GGA-2	VA9208-BGA-3	VA9208-BAA-3
VG1845DN	1-1/4	11.7 ¹	200	VG1845DNH928AGA	VG1845DNH928GGA	VG1845DNH938BGA	VG1845DNH938BAA
VG1845DP		18.7 ¹		VG1845DPH928AGA	VG1845DPH928GGA	VG1845DPH938BGA	VG1845DPH938BAA
VG1845DR		29.2		VG1845DRH928AGA	VG1845DRH928GGA	VG1845DRH938BGA	VG1845DRH938BAA
VG1845EP	1-1/2	18.7 ¹	200	VG1845EPH928AGA	VG1845EPH928GGA	VG1845EPH938BGA	VG1845EPH938BAA
VG1845ER		29.2 ¹		VG1845ERH928AGA	VG1845ERH928GGA	VG1845ERH938BGA	VG1845ERH938BAA
VG1845ES		46.8		VG1845ESH928AGA	VG1845ESH928GGA	VG1845ESH938BGA	VG1845ESH938BAA
VG1845FR	2	29.2 ¹	200	VG1845FRH928AGA	VG1845FRH928GGA	VG1845FRH938BGA	VG1845FRH938BAA
VG1845FS		46.8 ¹		VG1845FSH928AGA	VG1845FSH928GGA	VG1845FSH938BGA	VG1845FSH938BAA
VG1845FT		73.7		VG1845FTH928AGA	VG1845FTH928GGA	VG1845FTH938BGA	VG1845FTH938BAA
				Spring Return Port A Closed — Valve Spring Return Clockwise			
				VA9203-AGA-2Z	VA9203-GGA-2Z	VA9203-BGA-2	VA9203-BUA-2
VG1845AD	1/2	1.2 ¹	200	VG1845ADH943AGA	VG1845ADH943GGA	VG1845ADH943BGA	VG1845ADH943BUA
VG1845AE		1.9 ¹		VG1845AEH943AGA	VG1845AEH943GGA	VG1845AEH943BGA	VG1845AEH943BUA
VG1845AF		2.9 ¹		VG1845AFH943AGA	VG1845AFH943GGA	VG1845AFH943BGA	VG1845AFH943BUA
VG1845AG		4.7 ¹		VG1845AGH943AGA	VG1845AGH943GGA	VG1845AGH943BGA	VG1845AGH943BUA
VG1845AL		7.4 ¹		VG1845ALH943AGA	VG1845ALH943GGA	VG1845ALH943BGA	VG1845ALH943BUA
VG1845AN		11.7		VG1845ANH943AGA	VG1845ANH943GGA	VG1845ANH943BGA	VG1845ANH943BUA
VG1845BG	3/4	4.7 ¹	200	VG1845BGH943AGA	VG1845BGH943GGA	VG1845BGH943BGA	VG1845BGH943BUA
VG1845BL		7.4 ¹		VG1845BLH943AGA	VG1845BLH943GGA	VG1845BLH943BGA	VG1845BLH943BUA
VG1845BN		11.7		VG1845BNH943AGA	VG1845BNH943GGA	VG1845BNH943BGA	VG1845BNH943BUA
VG1845CL	1	7.4 ¹	200	VG1845CLH943AGA	VG1845CLH943GGA	VG1845CLH943BGA	VG1845CLH943BUA
VG1845CN		11.7 ¹		VG1845CNH943AGA	VG1845CNH943GGA	VG1845CNH943BGA	VG1845CNH943BUA
VG1845CP		18.7		VG1845CPH943AGA	VG1845CPH943GGA	VG1845CPH943BGA	VG1845CPH943BUA
				Spring Return Port A Closed — Valve Spring Return Clockwise			
				VA9208-AGA-2	VA9208-GGA-2	VA9208-BGA-3	VA9208-BAA-3
VG1845DN	1-1/4	11.7 ¹	200	VG1845DNH948AGA	VG1845DNH948GGA	VG1845DNH958BGA	VG1845DNH958BAA
VG1845DP		18.7 ¹		VG1845DPH948AGA	VG1845DPH948GGA	VG1845DPH958BGA	VG1845DPH958BAA
VG1845DR		29.2		VG1845DRH948AGA	VG1845DRH948GGA	VG1845DRH958BGA	VG1845DRH958BAA
VG1845EP	1-1/2	18.7 ¹	200	VG1845EPH948AGA	VG1845EPH948GGA	VG1845EPH958BGA	VG1845EPH958BAA
VG1845ER		29.2 ¹		VG1845ERH948AGA	VG1845ERH948GGA	VG1845ERH958BGA	VG1845ERH958BAA
VG1845ES		46.8		VG1845ESH948AGA	VG1845ESH948GGA	VG1845ESH958BGA	VG1845ESH958BAA
VG1845FR	2	29.2 ¹	200	VG1845FRH948AGA	VG1845FRH948GGA	VG1845FRH958BGA	VG1845FRH958BAA
VG1845FS		46.8 ¹		VG1845FSH948AGA	VG1845FSH948GGA	VG1845FSH958BGA	VG1845FSH958BAA
VG1845FT		73.7		VG1845FTH948AGA	VG1845FTH948GGA	VG1845FTH958BGA	VG1845FTH958BAA

1. Valve has a characterizing disk.

VG1000 Series Three-Way, Stainless Steel Trim, NPT End Connections Ball Valves with Spring-Return Electric Actuators without Switches (Continued)

Technical Specifications

VG1000 Series Three-Way, Stainless Steel Trim, NPT End Connections Ball Valves with Spring-Return Electric Actuators without Switches		
Service ¹		Hot Water, Chilled Water, 50/50 Glycol Solutions, and 15 psig (103 kPa) Saturated Steam for HVAC Systems
Fluid Temperature Limits	Water	-22°F to 284°F (-30°C to 140°C)
	Steam	15 psig (103 kPa) at 250°F (121°C)
Maximum Actuator Fluid Temperature Limits	212°F (100°C)	VA9203 Series Spring-Return Actuators VA9208 Series Spring-Return Actuators
	284°F (140°C)	VA9203 Series Spring-Return Actuators with M9000-561 Thermal Barrier Installed VA9208 Series Spring-Return Actuators with M9000-561 Thermal Barrier Installed
Valve Body Pressure Rating	Water	580 psig (4,000 kPa) at 203°F (95°C) (PN40) 464 psig (3,196 kPa) at 284°F (140°C) (PN40)
	Steam	15 psig (103 kPa) Saturated Steam (Applies to VA9208 Series Spring Return Actuator with M9000-561 Thermal Barrier Installed)
Maximum Closeoff Pressure		200 psid (1,378 kPa)
Maximum Recommended Operating Pressure Drop		50 psid (340 kPa)
Flow Characteristics	Three-Way	Equal Percentage Flow Characteristics of In-Line Port A (Coil) and Linear Flow Characteristics of Angle Port B (Bypass)
Rangeability ²		Greater than 500:1
Minimum Ambient Operating Temperature	-22°F (-30°C)	VA9203 Series Spring-Return Actuators
	-40°F (-40°C)	VA9208 Series Spring-Return Actuators
Maximum Ambient Operating Temperature ³ (Limited by the Actuator and Linkage)	Direct Mount	140°F (60°C): VA9208 Series Spring-Return Actuators
Leakage		0.01% of Maximum Flow per ANSI/FCI 70-2, Class 4
		1% of Maximum Flow
End Connections		National Pipe Thread (NPT)
Materials	Body	Forged Brass
	Ball	300 Series Stainless Steel
	Blowout-Proof Stem	300 Series Stainless Steel
	Seats	Graphite-Reinforced PTFE with Ethylene Propylene Diene Monomer (EPDM) O-Ring Backing
	Stem Seals	EPDM Double O-Rings
	Characterizing Disk	Amodel® AS-1145HS Polyphthalamide Resin
Compliance CRN		0C16910.5C

1. Proper water treatment is recommended; refer to the VDI 2035 Guideline.
2. Rangeability is defined as the ratio of maximum controllable flow to minimum controllable flow.
3. In steam applications, install the valve with the stem horizontal to the piping and wrap the valve and piping with insulation.



This product is made of copper alloy, which contains lead. The product is therefore not to be used on drinking water.



This product can expose you to chemicals including lead, which is known to the State of California to cause cancer, birth defects, or other reproductive harm. For more information, go to www.P65Warnings.ca.gov.

WARNING: BRASS MAY CONTAIN LEAD

To fulfill our obligations towards Article 33, in accordance to the European REACH Regulation No 1907/2006 EC, we hereby inform you that this article contains the following Substances of Very High Concern mentioned on the Candidate list:

- Lead

VG1000 Series Three-Way, Stainless Steel Trim, NPT End Connections Ball Valves with Spring-Return Electric Actuators with Switches

Description

VG1000 Series Ball Valves are designed to regulate the flow of hot or chilled water and, for some models, low-pressure steam in response to the demand of a controller in HVAC systems. Available in sizes 1/2 through 2 in. (DN15 through DN50), this family of two- and three-way forged brass valves is factory or field mounted to Johnson Controls® VA9104, M9106, M9109, and M9100 Series Non-Spring-Return and VA9203 and VA9208 Series Spring-Return Electric Actuators for on/off, floating, or proportional control.

Refer to the *VG1000 Series Forged Brass Ball Valves Product Bulletin (LIT-977132)* for important product application information.

Features

- Forged Brass Body — provides 580 psig static pressure rating.
- 300 Series Stainless Steel Ball and Stem Assembly — tolerates high-temperature water or 15 psi saturated steam with fluid temperatures of -22°F to 284°F (-30°C to 140°C) or where a higher degree of corrosion protection is desired.
- Ethylene Propylene Diene Monomer (EPDM) Double O-Ring Stem Seal — provides a leak-free seal; the packing has been tested and is leak-free after 200,000 cycles in iron-oxide contaminated water.
- Blowout-Proof Stem — protects the user from the risk of injury.



VG1000 Series Three-Way, Spring-Return, Stainless Steel Ball and Stem Ball Valve with End Switches

Repair Information

If the VG1000 Series Ball Valve fails to operate within its specifications, replace the valve body, actuator, or entire assembly. For replacement parts, contact the nearest Johnson Controls representative.

Selection Charts

Three-Way — Spring Return Valve Counterclockwise — Port A (Coil) Open with Switches (Not Rated for Steam Service)

Fluid Temperatures: -22°F to 212°F (-30°C to 100°C) Not Rated for Steam Service				AC 24 V			AC 85–264 V (VA9203) AC 120 V (VA9208)
Valve	Size, in.	Cv Port A/B	Closeoff psig	Floating	0 to 10 VDC Proportional	On/Off	On/Off
				Spring Return Port A Open — Valve Spring Return Counterclockwise — Actuator with One Switch			
				VA9203-AGB-2Z	VA9203-GGB-2Z	VA9203-BGB-2	VA9203-BUB-2
VG1845AD	1/2	1.2/0.7 ¹	200	VG1845AD+923AGB	VG1845AD+923GGB	VG1845AD+923BGB	VG1845AD+923BUB
VG1845AE		1.9/1.2 ¹		VG1845AE+923AGB	VG1845AE+923GGB	VG1845AE+923BGB	VG1845AE+923BUB
VG1845AF		2.9/1.9 ¹		VG1845AF+923AGB	VG1845AF+923GGB	VG1845AF+923BGB	VG1845AF+923BUB
VG1845AG		4.7/2.9 ¹		VG1845AG+923AGB	VG1845AG+923GGB	VG1845AG+923BGB	VG1845AG+923BUB
VG1845AL		7.4/4.7 ¹		VG1845AL+923AGB	VG1845AL+923GGB	VG1845AL+923BGB	VG1845AL+923BUB
VG1845AN		11.7/5.8		VG1845AN+923AGB	VG1845AN+923GGB	VG1845AN+923BGB	VG1845AN+923BUB
VG1845BG	3/4	4.7/2.9 ¹	200	VG1845BG+923AGB	VG1845BG+923GGB	VG1845BG+923BGB	VG1845BG+923BUB
VG1845BL		7.4/4.7 ¹		VG1845BL+923AGB	VG1845BL+923GGB	VG1845BL+923BGB	VG1845BL+923BUB
VG1845BN		11.7/5.8		VG1845BN+923AGB	VG1845BN+923GGB	VG1845BN+923BGB	VG1845BN+923BUB
VG1845CL	1	7.4/4.7 ¹	200	VG1845CL+923AGB	VG1845CL+923GGB	VG1845CL+923BGB	VG1845CL+923BUB
VG1845CN		11.7/7.4 ¹		VG1845CN+923AGB	VG1845CN+923GGB	VG1845CN+923BGB	VG1845CN+923BUB
VG1845CP		18.7/9.4		VG1845CP+923AGB	VG1845CP+923GGB	VG1845CP+923BGB	VG1845CP+923BUB
				Spring Return Port A Open — Valve Spring Return Counterclockwise — Actuator with Two Switches			
				VA9208-AGC-3	VA9208-GGC-3	VA9208-BGC-3	VA9208-BAC-3
VG1845DN	1-1/4	11.7/7.4 ¹	200	VG1845DN+938AGC	VG1845DN+938GGC	VG1845DN+938BGC	VG1845DN+938BAC
VG1845DP		18.7/11.7 ¹		VG1845DP+938AGC	VG1845DP+938GGC	VG1845DP+938BGC	VG1845DP+938BAC
VG1845DR		29.2/14.6		VG1845DR+938AGC	VG1845DR+938GGC	VG1845DR+938BGC	VG1845DR+938BAC
VG1845EP	1-1/2	18.7/11.7 ¹	200	VG1845EP+938AGC	VG1845EP+938GGC	VG1845EP+938BGC	VG1845EP+938BAC
VG1845ER		29.2/18.7 ¹		VG1845ER+938AGC	VG1845ER+938GGC	VG1845ER+938BGC	VG1845ER+938BAC
VG1845ES		46.8/23.4		VG1845ES+938AGC	VG1845ES+938GGC	VG1845ES+938BGC	VG1845ES+938BAC
VG1845FR	2	29.2/18.7 ¹	200	VG1845FR+938AGC	VG1845FR+938GGC	VG1845FR+938BGC	VG1845FR+938BAC
VG1845FS		46.8/29.2 ¹		VG1845FS+938AGC	VG1845FS+938GGC	VG1845FS+938BGC	VG1845FS+938BAC
VG1845FT		73.7/36.8		VG1845FT+938AGC	VG1845FT+938GGC	VG1845FT+938BGC	VG1845FT+938BAC

1. Valve has a characterizing disk.

VG1000 Series Three-Way, Stainless Steel Trim, NPT End Connections Ball Valves with Spring-Return Electric Actuators with Switches (Continued)

Three-Way — Spring Return Valve Clockwise — Port A (Coil) Closed with End Switches (Not Rated for Steam Service)

Fluid Temperatures: -22°F to 212°F (-30°C to 100°C) Not Rated for Steam Service				AC 24 V			AC 85–264 V (VA9203) AC 120 V (VA9208)
Valve	Size, in.	Cv Port A/B	Closeoff psig	Floating	0 to 10 VDC Proportional	On/Off	On/Off
				Spring Return Port A Closed — Valve Spring Return Clockwise — Actuator with One Switch			
				VA9203-AGB-2Z	VA9203-GGB-2Z	VA9203-BGB-2	VA9203-BUB-2
VG1845AD	1/2	1.2/0.7 ¹	200	VG1845AD+943AGB	VG1845AD+943GGB	VG1845AD+943BGB	VG1845AD+943BUB
VG1845AE		1.9/1.2 ¹		VG1845AE+943AGB	VG1845AE+943GGB	VG1845AE+943BGB	VG1845AE+943BUB
VG1845AF		2.9/1.9 ¹		VG1845AF+943AGB	VG1845AF+943GGB	VG1845AF+943BGB	VG1845AF+943BUB
VG1845AG		4.7/2.9 ¹		VG1845AG+943AGB	VG1845AG+943GGB	VG1845AG+943BGB	VG1845AG+943BUB
VG1845AL		7.4/4.7 ¹		VG1845AL+943AGB	VG1845AL+943GGB	VG1845AL+943BGB	VG1845AL+943BUB
VG1845AN		11.7/5.8		VG1845AN+943AGB	VG1845AN+943GGB	VG1845AN+943BGB	VG1845AN+943BUB
VG1845BG	3/4	4.7/2.9 ¹	200	VG1845BG+943AGB	VG1845BG+943GGB	VG1845BG+943BGB	VG1845BG+943BUB
VG1845BL		7.4/4.7 ¹		VG1845BL+943AGB	VG1845BL+943GGB	VG1845BL+943BGB	VG1845BL+943BUB
VG1845BN		11.7/5.8		VG1845BN+943AGB	VG1845BN+943GGB	VG1845BN+943BGB	VG1845BN+943BUB
VG1845CL	1	7.4/4.7 ¹	200	VG1845CL+943AGB	VG1845CL+943GGB	VG1845CL+943BGB	VG1845CL+943BUB
VG1845CN		11.7/7.4 ¹		VG1845CN+943AGB	VG1845CN+943GGB	VG1845CN+943BGB	VG1845CN+943BUB
VG1845CP		18.7/9.4		VG1845CP+943AGB	VG1845CP+943GGB	VG1845CP+943BGB	VG1845CP+943BUB
				Spring Return Port A Closed — Valve Spring Return Clockwise — Actuator with Two Switches			
				VA9208-AGC-3	VA9208-GGC-3	VA9208-BGC-3	VA9208-BAC-3
VG1845DN	1-1/4	11.7/7.4 ¹	200	VG1845DN+958AGC	VG1845DN+958GGC	VG1845DN+958BGC	VG1845DN+958BAC
VG1845DP		18.7/11.7 ¹		VG1845DP+958AGC	VG1845DP+958GGC	VG1845DP+958BGC	VG1845DP+958BAC
VG1845DR		29.2/14.6		VG1845DR+958AGC	VG1845DR+958GGC	VG1845DR+958BGC	VG1845DR+958BAC
VG1845EP	1-1/2	18.7/11.7 ¹	200	VG1845EP+958AGC	VG1845EP+958GGC	VG1845EP+958BGC	VG1845EP+958BAC
VG1845ER		29.2/18.7 ¹		VG1845ER+958AGC	VG1845ER+958GGC	VG1845ER+958BGC	VG1845ER+958BAC
VG1845ES		46.8/23.4		VG1845ES+958AGC	VG1845ES+958GGC	VG1845ES+958BGC	VG1845ES+958BAC
VG1845FR	2	29.2/18.7 ¹	200	VG1845FR+958AGC	VG1845FR+958GGC	VG1845FR+958BGC	VG1845FR+958BAC
VG1845FS		46.8/29.2 ¹		VG1845FS+958AGC	VG1845FS+958GGC	VG1845FS+958BGC	VG1845FS+958BAC
VG1845FT		73.7/36.8		VG1845FT+958AGC	VG1845FT+958GGC	VG1845FT+958BGC	VG1845FT+958BAC

1. Valve has a characterizing disk.



WARNING

This product is made of copper alloy, which contains lead. The product is therefore not to be used on drinking water.



WARNING

This product can expose you to chemicals including lead, which is known to the State of California to cause cancer, birth defects, or other reproductive harm. For more information, go to www.P65Warnings.ca.gov.

WARNING: BRASS MAY CONTAIN LEAD

To fulfill our obligations towards Article 33, in accordance to the European REACH Regulation No 1907/2006 EC, we hereby inform you that this article contains the following Substances of Very High Concern mentioned on the Candidate list:

- Lead

VG1000 Series Three-Way, Stainless Steel Trim, NPT End Connections Ball Valves with Spring-Return Electric Actuators with Switches (Continued)

Valve Assemblies with M9000-561 Thermal Barrier Installed — Rated for High-Temperature Fluid Service, Three-Way — Spring Return — with End Switches (Part 1 of 2)

Fluid Temperatures: -22°F to 284°F (-30°C to 140°C) Water and 15 psi Steam				AC 24 V			AC 85–264 V (VA9203) AC 120 V (VA9208)
Valve	Size, in.	Cv Port A/B	Closeoff psig	Floating	0 to 10 VDC Proportional	On/Off	On/Off
				Spring Return Port A Open — Valve Spring Return Counterclockwise — Actuator with One Switch and 48 in. (18 AWG) Appliance Cables			
				VA9203-AGB-2Z	VA9203-GGB-2Z	VA9203-BGB-2	VA9203-BUB-2
VG1845AD	1/2	1.2/0.7 ¹	200	VG1845ADH923AGB	VG1845ADH923GGB	VG1845ADH923BGB	VG1845ADH923BUB
VG1845AE		1.9/1.2 ¹		VG1845AEH923AGB	VG1845AEH923GGB	VG1845AEH923BGB	VG1845AEH923BUB
VG1845AF		2.9/1.9 ¹		VG1845AFH923AGB	VG1845AFH923GGB	VG1845AFH923BGB	VG1845AFH923BUB
VG1845AG		4.7/2.9 ¹		VG1845AGH923AGB	VG1845AGH923GGB	VG1845AGH923BGB	VG1845AGH923BUB
VG1845AL		7.4/4.7 ¹		VG1845ALH923AGB	VG1845ALH923GGB	VG1845ALH923BGB	VG1845ALH923BUB
VG1845AN		11.7/5.8		VG1845ANH923AGB	VG1845ANH923GGB	VG1845ANH923BGB	VG1845ANH923BUB
VG1845BG	3/4	4.7/2.9 ¹	200	VG1845BGH923AGB	VG1845BGH923GGB	VG1845BGH923BGB	VG1845BGH923BUB
VG1845BL		7.4/4.7 ¹		VG1845BLH923AGB	VG1845BLH923GGB	VG1845BLH923BGB	VG1845BLH923BUB
VG1845BN		11.7/5.8		VG1845BNH923AGB	VG1845BNH923GGB	VG1845BNH923BGB	VG1845BNH923BUB
VG1845CL	1	7.4/4.7 ¹	200	VG1845CLH923AGB	VG1845CLH923GGB	VG1845CLH923BGB	VG1845CLH923BUB
VG1845CN		11.7/7.4 ¹		VG1845CNH923AGB	VG1845CNH923GGB	VG1845CNH923BGB	VG1845CNH923BUB
VG1845CP		18.7/9.4		VG1845CPH923AGB	VG1845CPH923GGB	VG1845CPH923BGB	VG1845CPH923BUB
				Spring Return Port A Open — Valve Spring Return Counterclockwise — Actuator with Two Switches			
				VA9208-AGC-3	VA9208-GGC-3	VA9208-BGC-3	VA9208-BAC-3
VG1845DN	1-1/4	11.7/7.4 ¹	200	VG1845DNH938AGC	VG1845DNH938GGC	VG1845DNH938BGC	VG1845DNH938BAC
VG1845DP		18.7/11.7 ¹		VG1845DPH938AGC	VG1845DPH938GGC	VG1845DPH938BGC	VG1845DPH938BAC
VG1845DR		29.2/14.6		VG1845DRH938AGC	VG1845DRH938GGC	VG1845DRH938BGC	VG1845DRH938BAC
VG1845EP	1-1/2	18.7/11.7 ¹	200	VG1845EPH938AGC	VG1845EPH938GGC	VG1845EPH938BGC	VG1845EPH938BAC
VG1845ER		29.2/18.7 ¹		VG1845ERH938AGC	VG1845ERH938GGC	VG1845ERH938BGC	VG1845ERH938BAC
VG1845ES		46.8/23.4		VG1845ESH938AGC	VG1845ESH938GGC	VG1845ESH938BGC	VG1845ESH938BAC
VG1845FR	2	29.2/18.7 ¹	200	VG1845FRH938AGC	VG1845FRH938GGC	VG1845FRH938BGC	VG1845FRH938BAC
VG1845FS		46.8/29.2 ¹		VG1845FSH938AGC	VG1845FSH938GGC	VG1845FSH938BGC	VG1845FSH938BAC
VG1845FT		73.7/36.8		VG1845FTH938AGC	VG1845FTH938GGC	VG1845FTH938BGC	VG1845FTH938BAC
				Spring Return Port A Closed — Valve Spring Return Clockwise — Actuator with One Switch			
				VA9203-AGB-2Z	VA9203-GGB-2Z	VA9203-BGB-2	VA9203-BUB-2
VG1845AD	1/2	1.2/0.7	200	VG1845ADH943AGB	VG1845ADH943GGB	VG1845ADH943BGB	VG1845ADH943BUB
VG1845AE		1.9/1.2 ¹		VG1845AEH943AGB	VG1845AEH943GGB	VG1845AEH943BGB	VG1845AEH943BUB
VG1845AF		2.9/1.9 ¹		VG1845AFH943AGB	VG1845AFH943GGB	VG1845AFH943BGB	VG1845AFH943BUB
VG1845AG		4.7/2.9 ¹		VG1845AGH943AGB	VG1845AGH943GGB	VG1845AGH943BGB	VG1845AGH943BUB
VG1845AL		7.4/4.7 ¹		VG1845ALH943AGB	VG1845ALH943GGB	VG1845ALH943BGB	VG1845ALH943BUB
VG1845AN		11.7/5.8		VG1845ANH943AGB	VG1845ANH943GGB	VG1845ANH943BGB	VG1845ANH943BUB
VG1845BG	3/4	4.7/2.9 ¹	200	VG1845BGH943AGB	VG1845BGH943GGB	VG1845BGH943BGB	VG1845BGH943BUB
VG1845BL		7.4/4.7 ¹		VG1845BLH943AGB	VG1845BLH943GGB	VG1845BLH943BGB	VG1845BLH943BUB
VG1845BN		11.7/5.8		VG1845BNH943AGB	VG1845BNH943GGB	VG1845BNH943BGB	VG1845BNH943BUB
VG1845CL	1	7.4/4.7 ¹	200	VG1845CLH943AGB	VG1845CLH943GGB	VG1845CLH943BGB	VG1845CLH943BUB
VG1845CN		11.7/7.4 ¹		VG1845CNH943AGB	VG1845CNH943GGB	VG1845CNH943BGB	VG1845CNH943BUB
VG1845CP		18.7/9.4		VG1845CPH943AGB	VG1845CPH943GGB	VG1845CPH943BGB	VG1845CPH943BUB

The performance specifications are nominal and conform to acceptable industry standards. For applications at conditions beyond these specifications, consult the local Johnson Controls office. Johnson Controls shall not be liable for damages resulting from misapplication or misuse of its products. © 2019 Johnson Controls. www.johnsoncontrols.com

VG1000 Series Three-Way, Stainless Steel Trim, NPT End Connections Ball Valves with Spring-Return Electric Actuators with Switches (Continued)

Valve Assemblies with M9000-561 Thermal Barrier Installed — Rated for High-Temperature Fluid Service, Three-Way — Spring Return — with End Switches (Part 2 of 2)

Fluid Temperatures: -22°F to 284°F (-30°C to 140°C) Water and 15 psig Steam				AC 24 V			AC 85–264 V (VA9203) AC 120 V (VA9208)
Valve	Size, in.	Cv Port A/B	Closeoff psig	Floating	0 to 10 VDC Proportional	On/Off	On/Off
				Spring Return Port A Closed — Valve Spring Return Clockwise — Actuator with Two Switches			
				VA9208-AGC-3	VA9208-GGC-3	VA9208-BGC-3	VA9208-BAC-3
VG1845DN	1-1/4	11.7/7.4 ¹	200	VG1845DNH958AGC	VG1845DNH958GGC	VG1845DNH958BGC	VG1845DNH958BAC
VG1845DP		18.7/11.7 ¹		VG1845DPH958AGC	VG1845DPH958GGC	VG1845DPH958BGC	VG1845DPH958BAC
VG1845DR		29.2/14.6		VG1845DRH958AGC	VG1845DRH958GGC	VG1845DRH958BGC	VG1845DRH958BAC
VG1845EP	1-1/2	18.7/11.7 ¹	200	VG1845EPH958AGC	VG1845EPH958GGC	VG1845EPH958BGC	VG1845EPH958BAC
VG1845ER		29.2/18.7 ¹		VG1845ERH958AGC	VG1845ERH958GGC	VG1845ERH958BGC	VG1845ERH958BAC
VG1845ES		46.8/23.4		VG1845ESH958AGC	VG1845ESH958GGC	VG1845ESH958BGC	VG1845ESH958BAC
VG1845FR	2	29.2/18.7 ¹	200	VG1845FRH958AGC	VG1845FRH958GGC	VG1845FRH958BGC	VG1845FRH958BAC
VG1845FS		46.8/29.2 ¹		VG1845FSH958AGC	VG1845FSH958GGC	VG1845FSH958BGC	VG1845FSH958BAC
VG1845FT		73.7/36.8		VG1845FTH958AGC	VG1845FTH958GGC	VG1845FTH958BGC	VG1845FTH958BAC

1. Valve has a characterizing disk.

Technical Specifications

VG1000 Series Three-Way, Stainless Steel Trim, NPT End Connections Ball Valves with Spring-Return Electric Actuators with Switches		
Service ¹	Hot Water, Chilled Water, 50/50 Glycol Solutions, and 15 psig (103 kPa) Saturated Steam for HVAC Systems	
Fluid Temperature Limits	Water	-22°F to 284°F (-30°C to 140°C)
	Steam	15 psig (103 kPa) at 250°F (121°C)
Maximum Actuator Fluid Temperature Limits	212°F (100°C)	VA9203 Series Spring-Return Actuators VA9208 Series Spring-Return Actuators
	284°F (140°C)	VA9203 with M9000-561 Thermal Barrier VA9208 with M9000-561 Thermal Barrier
Valve Body Pressure Rating	Water	580 psig (4,000 kPa) at 203°F (95°C) (PN40) 464 psig (3,199 kPa) at 284°F (140°C) (PN40)
	Steam	15 psig (103 kPa) Saturated Steam (Applies to VA9203 Series or VA9208 Series Actuators with M9000-561 Thermal Barrier Installed)
Maximum Closeoff Pressure	200 psid (1,378 kPa)	
Maximum Recommended Operating Pressure Drop	50 psid (340 kPa)	
Flow Characteristics	Three-Way	Equal Percentage Flow Characteristics of In-Line Port (Coil) and Linear Flow Characteristics of Angle Port B (Bypass)
Rangeability ²	Greater than 500:1	
Minimum Ambient Operating Temperature	-22°F (-30°C)	VA9203 Series Spring-Return Actuators
	-40°F (-40°C)	VA9208 Series Spring-Return Actuators
Maximum Ambient Operating Temperature ³ (Limited by the Actuator and Linkage)	Direct Mount	140°F (60°C): VA9208 Series Spring-Return Actuators
Leakage	0.01% of Maximum Flow per ANSI/FCI 70-2, Class 4 1% of Maximum Flow for Three-Way Bypass Port	
End Connections	National Pipe Thread (NPT)	
Materials	Body	Forged Brass
	Ball	300 Series Stainless Steel
	Blowout-Proof Stem	300 Series Stainless Steel
	Seats	Graphite-Reinforced PTFE with EPDM O-Ring Backing
	Stem Seals	EPDM Double O-Rings
	Characterizing Disk	Amodel® AS-1145HS Polyphthalamide Resin
Compliance CRN	0C16910.5C	

1. Proper water treatment is recommended; refer to the VDI 2035 Guideline.

2. Rangeability is defined as the ratio of maximum controllable flow to minimum controllable flow.

3. In steam applications, install the valve with the stem horizontal to the piping and wrap the valve and piping with insulation.

VG1000 Series Forged Brass Ball Valves for Assembly in the Field

Description

VG1000 Series Ball Valves are designed to regulate the flow of hot or chilled water and, for some models, low-pressure steam in response to the demand of a controller in HVAC systems. Available in sizes 1/2 through 2 in. (DN15 through DN50), this family of two- and three-way forged brass valves is factory or field mounted to Johnson Controls® VA9104 and VA9300 Series Non-Spring-Return and VA9203 and VA9208 Series Spring-Return Electric Actuators for on/off, floating, or proportional control.

Refer to the *VG1000 Series Forged Brass Ball Valves Product Bulletin (LIT-977132)* for important product application information and single point of contact information.

Features

- National Pipe Thread (NPT), sweat, and press end connections—provide the right valve for a broad range of applications, reduce installation time while reducing the need for adapters, and increase system reliability.

- 300 Series stainless steel ball and stem assembly—tolerates high-temperature water or 15 psi saturated steam with fluid temperatures of -22°F to 284°F (-30°C to 140°C) or where a higher degree of corrosion protection is desired.
- Ethylene Propylene Diene Monomer (EPDM) double O-ring stem seal—provides a leak-free seal; the packing has been tested and is leak-free after 200,000 cycles in iron-oxide contaminated water.
- Graphite-reinforced Polytetrafluoroethylene (PTFE) seats—include 15% graphite-reinforced ball seats, providing better wear resistance.
- 200 psi closeoff pressure rating—provides tight shutoff.
- 500:1 rangeability—provides accurate control under all load conditions.
- Chrome-plated brass ball and stem assembly standard—handles both chilled and hot water applications with a fluid temperature range of 23°F to 203°F (-5°C to 95°C).
- Blowout-proof stem—protects the user from the risk of injury.

VG1000 Series Ball Valves



Selection Charts

Valid Ball Valve, Electric Actuator, Linkage Kit, and Weather Shield Combinations (for Assembly in the Field) (Part 1 of 3)

Valve Size, in. (DN)	Valve Code Numbers			Actuator Base Number ¹	Linkage Kit Code Number			Weather Shield
	NPT End Connection	Sweat End Connection	Press End Connection		Fluid Temperatures (<203°F [95°C])	Fluid Temperatures (<212°F [100°C])	Fluid Temperatures (≥212°F [100°C])	
1/2 (DN15)	VG1241Ax VG1841Ax		VG1291Ax VG1891Ax	VA9104 ²	None Required	Not Rated	Not Rated	M9000-342
				M9104 ²	Not Available			
				VA9300	None Required			
				M9300	M9310-500			
				VA9203	None Required			
				M9203	M9000-560			
	VG1245Ax VG1845Ax	VG1275Ax VG1875Ax	VG1295Ax VG1895Ax	VA9104 ²	None Required	M9000-561		
				M9104 ²	Not Available			
				VA9300	None Required			
				M9300	M9310-500			
				VA9203	None Required			
				M9203	M9000-560			

WARNING This product is made of copper alloy, which contains lead. The product is therefore not to be used on drinking water.

WARNING This product can expose you to chemicals including lead, which is known to the State of California to cause cancer, birth defects, or other reproductive harm. For more information, go to www.P65Warnings.ca.gov.

WARNING: BRASS MAY CONTAIN LEAD
To fulfill our obligations towards Article 33, in accordance to the European REACH Regulation No 1907/2006 EC, we hereby inform you that this article contains the following Substances of Very High Concern mentioned on the Candidate list:

- Lead

VG1000 Series Forged Brass Ball Valves for Assembly in the Field (Continued)

Valid Ball Valve, Electric Actuator, Linkage Kit, and Weather Shield Combinations (for Assembly in the Field) (Part 2 of 3)

Valve Size, in. (DN)	Valve Code Numbers			Actuator Base Number ¹	Linkage Kit Code Number			Weather Shield							
	NPT End Connection	Sweat End Connection	Press End Connection		Fluid Temperatures (<203°F [95°C])	Fluid Temperatures (<212°F [100°C])	Fluid Temperatures (≥212°F [100°C])								
3/4 (DN20)	VG1241Bx VG1841Bx		VG1291Bx VG1891Bx	VA9104 ²	None Required	Not Rated	Not Rated	M9000-342							
				M9104 ²	Not Available										
				VA9300	None Required										
				M9300	M9310-500										
				VA9203	None Required										
				M9203	M9000-560										
	VG1245Bx VG1845Bx	VG1275Bx VG1875Bx	VG1295Bx VG1895Bx	VA9104 ²	None Required		M9000-561								
				M9104 ²	Not Available										
				VA9300	None Required										
				M9300	M9310-500										
				VA9203	None Required										
				M9203	M9000-560										
				1 (DN25)	VG1241Cx VG1841Cx	VG1271Cx VG1871Cx			VG1291Cx VG1891Cx	VA9104 ²	None Required	Not Rated	Not Rated	M9000-342	
										M9104 ²	Not Available				
VA9300	None Required														
M9300	M9310-500														
VA9203	None Required														
M9203	M9000-560														
VG1245Cx VG1845Cx	VG1275Cx VG1875Cx	VG1295Cx VG1895Cx	VA9104 ²		None Required		M9000-561								
			M9104 ²		Not Available										
			VA9300		None Required										
			M9300		M9310-500										
			VA9203		None Required										
			M9203		M9000-560										
			1-1/4 (DN32)		VG1241Dx VG1841Dx				VA9300	None Required	Not Rated	Not Rated	M9000-342		
									M9300	M9310-500					
VA9208	None Required														
M9208	M9000-550														
VG1245Dx VG1845Dx					VA9300	None Required		M9000-561							
					M9300	M9310-500									
					VA9208	None Required									
					M9208	M9000-560									
					1-1/2 (DN40)	VG1241Ex VG1841Ex				VA9300	None Required	Not Rated		Not Rated	M9000-342
										M9300	M9310-500				
VA9208	None Required														
M9208	M9000-560														
VG1245Ex VG1845Ex				VA9300		None Required		M9000-561							
				M9300		M9310-500									
				VA9208		None Required									
				M9208		M9000-560									

The performance specifications are nominal and conform to acceptable industry standards. For applications at conditions beyond these specifications, consult the local Johnson Controls office. Johnson Controls shall not be liable for damages resulting from misapplication or misuse of its products. © 2019 Johnson Controls. www.johnsoncontrols.com

VG1000 Series Forged Brass Ball Valves for Assembly in the Field (Continued)

Valid Ball Valve, Electric Actuator, Linkage Kit, and Weather Shield Combinations (for Assembly in the Field) (Part 3 of 3)

Valve Size, in. (DN)	Valve Code Numbers			Actuator Base Number ¹	Linkage Kit Code Number			Weather Shield
	NPT End Connection	Sweat End Connection	Press End Connection		Fluid Temperatures (<203°F [95°C])	Fluid Temperatures (<212°F [100°C])	Fluid Temperatures (≥212°F [100°C])	
2 (DN50)	VG1241Fx VG1841Fx			VA9300	None Required	Not Rated	Not Rated	M9000-342
				M9300	M9310-500			
				VA9208	None Required			
				M9208	M9000-560			
	VG1245Fx VG1845Fx			VA9300	None Required	M9000-561		
				M9300	M9310-500			
				VA9208	None Required			
				M9208	M9000-560			

1. VA9104, M9104, VA9300, and M9300 Series Actuators are non-spring-return, and VA9203, M9203, VA9208, and M9208 Series Actuators are spring-return. Note: VA9104, M9104, VA9300, M9300, VA9203, M9203, VA9208, and M9208 have a maximum fluid temperature limit of 212°F (100°C) unless used with the M9000-561 Thermal Barrier.
2. To avoid excessive wear or drive time on the motor for VA9104 and M9104 use a controller and/or software that provides a timeout function to remove the signal at the end of rotation (stall). The IGx and GGx models have an automatic shutoff to avoid excessive wear or drive time on the motor.

Ball Valves (for Assembly in the Field)¹

Size, in. (mm)	Closeoff psig	Characterizing Disc	Control Port Cv (Kvs)	Bypass Port Cv (Kvs) (Three-Way Only)	Plated Brass Ball and Stem 23°F to 203°F (-5°C to 95°C) Fluid Temperature		Stainless Steel Ball and Stem -22°F to 284°F (-30°C to 140°C) Fluid Temperature, 15 psi Saturated Steam		
					Two-Way	Three-Way	Two-Way	Three-Way	
					NPT Threaded End Connection Valves				
1/2 (DN15)	200	Yes	1.2 (1.0)	0.7 (0.6)	VG1241AD	VG1841AD	VG1245AD	VG1845AD	
			1.9 (1.6)	1.2 (1.0)	VG1241AE	VG1841AE	VG1245AE	VG1845AE	
			2.9 (2.5)	1.9 (1.6)	VG1241AF	VG1841AF	VG1245AF	VG1845AF	
			4.7 (4.0)	2.9 (2.5)	VG1241AG	VG1841AG	VG1245AG	VG1845AG	
			7.4 (6.3)	4.7 (4.0)	VG1241AL	VG1841AL	VG1245AL	VG1845AL	
3/4 (DN20)	200	No	11.7 (10.0)	5.8 (5.0)	VG1241AN	VG1841AN	VG1245AN	VG1845AN	
			Yes	4.7 (4.0)	2.9 (2.5)	VG1241BG	VG1841BG	VG1245BG	VG1845BG
				7.4 (6.3)	4.7 (4.0)	VG1241BL	VG1841BL	VG1245BL	VG1845BL
1 (DN25)	200	No	11.7 (10.0)	5.8 (5.0)	VG1241BN	VG1841BN	VG1245BN	VG1845BN	
			Yes	7.4 (6.3)	4.7 (4.0)	VG1241CL	VG1841CL	VG1245CL	VG1845CL
				11.7 (10.0)	5.8 (5.0)	VG1241CN	VG1841CN	VG1245CN	VG1845CN
1-1/4 (DN32)	200	No	18.7 (16.0)	9.4 (8.0)	VG1241CP	VG1841CP	VG1245CP	VG1845CP	
			Yes	11.7 (10.0)	5.8 (5.0)	VG1241DN	VG1841DN	VG1245DN	VG1845DN
				18.7 (16.0)	9.4 (8.0)	VG1241DP	VG1841DP	VG1245DP	VG1845DP
1-1/2 (DN40)	200	No	29.2 (25.0)	14.6 (12.5)	VG1241DR	VG1841DR	VG1245DR	VG1845DR	
			Yes	18.7 (16.0)	9.4 (8.0)	VG1241EP	VG1841EP	VG1245EP	VG1845EP
				29.2 (25.0)	14.6 (12.5)	VG1241ER	VG1841ER	VG1245ER	VG1845ER
2 (DN50)	200	No	46.8 (40.0)	23.4 (20.0)	VG1241ES	VG1841ES	VG1245ES	VG1845ES	
			Yes	29.2 (25.0)	14.6 (12.5)	VG1241FR	VG1841FR	VG1245FR	VG1845FR
				46.8 (40.0)	23.4 (20.0)	VG1241FS	VG1841FS	VG1245FS	VG1845FS
		No	73.7 (63.0)	36.8 (31.5)	VG1241FT	VG1841FT	VG1245FT	VG1845FT	

1. Before retrofitting older valves with VA9104, VA9300, VA9203, or VA9208 actuators, be sure that the valves have a tapped hole in the center of the valve stem and no threads in the flange holes. These direct-mount actuators do not fit older valves designed without a tapped center stem hole or with threaded flange mounting holes unless they are used with the M9000-561 Thermal Barrier kit.

Repair Parts

Linkage	Replacement Description	Code Number
M9000-560	Linkage for VA9203/M9203 and VA9203/M9208 Series Actuators	Unit Replacement
M9000-561	Thermal Barrier for VA9104/VA9203/VA9208/VA9300Series Actuators	Unit Replacement
M9310-500	Linkage for VA9300/M9300 Actuators	Unit Replacement

VG1000 Series Forged Brass Ball Valves for Assembly in the Field (Continued)

Technical Specifications

VG1000 Series Forged Brass Ball Valves for Assembly in the Field		
Service¹		Hot water, chilled water, 50/50 Glycol solutions, and 15 psig (103 kPa) saturated steam ² for HVAC systems
Fluid Temperature Limits	Water	VG12x1 and VG18x1 Series: 23°F to 203°F (-5°C to 95°C) VG12x5 and VG18x5 Series: -22°F to 284°F (-30°C to 140°C)
	Steam²	VG12x1 and VG18x1 Series: Not Rated for Steam Service VG12x5 and VG18x5 Series: 15 psig (103 kPa) at 250°F (121°C)
Maximum Actuator Fluid Temperature Limits	212°F (100°C)	VA9104, VA9300, VA9203, VA9208
	284°F (140°C)	VA9104, VA9300, VA9203, VA9208 with M9000-561 Thermal Barrier
Valve Body Pressure Rating	Water	VG1241, VG1245, VG1841, and VG1845 Series: 580 psig (4,000 kPa) (PN40), 464 psig (3,196 kPa) at 284°F (140°C) (PN40)
		VG1275 and VG1875 Series: 300 psig (2,067 kPa)
		VG1295 and VG1895 Series: 300 psig (2,067 kPa)
	Steam²	15 psig (103 kPa) saturated steam
Maximum Closeoff Pressure	VG12x1 and VG12x5 Series:	200 psid (1,378 kPa)
Maximum Recommended Operating Pressure Drop		50 psid (340 kPa)
Flow Characteristics	Two-Way	Equal percentage
	Three-Way	Equal percentage flow characteristics of in-line port (coil) and linear flow characteristics of angle port (bypass)
Rangeability³		Greater than 500:1
Minimum Ambient Operating Temperature	-4°F (-20°C)	VA9104 Series Non-Spring-Return Actuators
	-22°F (-30°C)	VA9203 and VA9300 Series Spring-Return Actuators
	-40°F (-40°C)	VA9208 Series Spring-Return Actuators
Maximum Ambient Operating Temperature² (Limited by the Actuator and Linkage)	140°F (60°C)	VA9104 and M9300 Series Non-Spring-Return Actuators VA9203 and VA9208 Series Spring-Return Actuators
Leakage		0.01% of Maximum Flow per ANSI/FCI 70-2, Class 4
		1% of maximum flow for three-way bypass port
End Connections		NPT: 1/2 through 2 in.
		Sweat: 1/2 through 1 in. (DN15 through DN25)
		Press (ProPress® Compatible): 1/2 through 1 in. (DN15 through DN25)
Materials	Body	Forged Brass
	Ball	VG12x1 and VG18x1 Series: chrome plated brass
		VG12x5 and VG18x5 Series: 300 Series stainless steel
	Blowout-Proof Stem	VG12x1 and VG18x1 Series: nickel plated brass
		VG12x5 and VG18x5 Series: 300 Series stainless steel
	Seats	Graphite-Reinforced PTFE with EPDM O-Ring backing
Stem Seals	EPDM Double O-Rings	
Characterizing Disk		AMODEL® AS-1145HS Polyphthalamide Resin
Compliance CRN		For NPT threaded valves with stainless steel ball (VG1x45...): 0C16910.5C

1. Refer to the VDI 2035 Guideline for recommended proper water treatment.

2. In steam applications, install the valve with the stem horizontal to the piping and wrap the valve and piping with insulation.

3. Rangeability is defined as the ratio of maximum controllable flow to minimum controllable flow.

VG1000 Smart Ball Valves

Description

VG1000 Series Ball Valves are designed to control the flow of hot or chilled water in HVAC systems. Available in sizes 1/2 through 1 in. (DN15 through DN25), this family of two- and three-way forged brass valves is factory or field mounted to Johnson Controls® VMA Modular Assembly Controller Series. The controller allows for a customized response to environmental conditions and is particularly well suited for applications such as chilled beams and fan coils.



VG1000 Series Ball Valves Shown with Factory-Mounted VMA

Features

- factory-mounted VMA1656 programmable VAV box controller series
- forged brass body
- Amodel® flow characterizing disk
- 200 psi closeoff pressure rating
- chrome-plated brass ball and stem assembly standard
- 500:1 rangeability

Selection Chart

Ordering Data¹

V	Valve Global															
1	Product		1 = Forged Brass Ball Valve													
3	Family															
2	Body Type and Flow Characteristic		2 = Two-Way, with Equal Percentage Flow Characteristics													
4			8 = Three-Way Mixing, with Equal Percentage Flow Characteristics of In-line Port and Linear Flow Characteristics of Angle-Port													
4	End Connection		4 = Threaded - NPT Taper													
5																
1	Trim		1 = Chrome-Plated Brass Ball and Nickel-Plated Brass Stem													
6																
A	E	Size and Maximum Cv	Size	Control Disk	Control Port Cv (Kvs)	Bypass Port Cv (Kvs) (Three-Way Only)										
7	8	(Kvs = Cv x 0.857)	AD = 1/2 in. (DN15)	Yes	1.2 (1.0)	0.7 (0.6)										
			AE = 1/2 in. (DN15)	Yes	1.9 (1.6)	1.2 (1.0)										
			AF = 1/2 in. (DN15)	Yes	2.9 (2.5)	1.9 (1.6)										
			AG = 1/2 in. (DN15)	Yes	4.7 (4.0)	2.9 (2.5)										
			AL = 1/2 in. (DN15)	Yes	7.4 (6.3)	4.7 (4.0)										
			AN = 1/2 in. (DN15)	No	11.7 (10.0)	5.8 (5.0)										
			BG = 3/4 in. (DN20)	Yes	4.7 (4.0)	2.9 (2.5)										
			BL = 3/4 in. (DN20)	Yes	7.4 (6.3)	4.7 (4.0)										
			BN = 3/4 in. (DN20)	No	11.7 (10.0)	5.8 (5.0)										
			CL = 1 in. (DN25)	Yes	7.4 (6.3)	4.7 (4.0)										
			CN = 1 in. (DN25)	Yes	11.7 (10.0)	7.4 (6.3)										
			CP = 1 in. (DN25)	No	18.7 (16.0)	9.4 (8.0)										
+	Actuator		+ = Factory-Mounted Actuator													
9	Mounting		(Leave Fields 9 through 15 blank for valve without factory-mounted actuator.) H = High Temperature Linkage (VA9104, VA9203, and VA9208 actuators)													
1	2	3	4	5	6	7	8	9	10	11	12	13	14	15	= Field	
V	G	1	2	4	1	A	E	+								
Valve								+	Actuator							

Example: Forged brass ball valve, two-way, threaded (NPT), brass trim, equal %, 1/2 in. (DN15) 1.9 Cv.

1. Before retrofitting older valves with VMA1656 Modular Assembly Controller Series be sure that the valves have a tapped hole in the center of the valve stem and no threads in the flange holes. These direct mount actuators do not fit older valves designed without a tapped center stem hole or with threaded flange mounting holes.

VG1000 Smart Ball Valves (Continued)

Shipping Weights, lb (kg) (Includes the VMA)

Valve Code Number	Description	Shipping Weight, lb (kg)
VG12xxAx	1/2 in. (DN15) Two-Way Forged Brass Ball Valve	1.6 (0.7)
VG12xxBx	3/4 in. (DN20) Two-Way Forged Brass Ball Valve	1.6 (0.7)
VG12xxCx	1 in. (DN25) Two-Way Forged Brass Ball Valve	1.6 (0.7)
VG18xxAx	1/2 in. (DN15) Three-Way Forged Brass Ball Valve	1.6 (0.7)
VG18xxBx	3/4 in. (DN20) Three-Way Forged Brass Ball Valve	1.6 (0.7)
VG18xxCx	1 in. (DN25) Three-Way Forged Brass Ball Valve	1.6 (0.7)

Repair Parts

Linkage	Replacement Description	Replacement Part Code Number
M9000-551	Linkage with Handle for VA9104 Series Actuators and VMA1656 Modular Assembly Controller Series	Unit Replacement
M9000-561	Thermal Barrier for VA9104/VA9203/VA9208 Series Actuators and VMA1656 Modular Assembly Controller Series	Unit Replacement

See the figure below for dimension drawings of the VMA1656, VG1241, and VG1841 Series NPT End Connection Ball Valves. See the table below for specific model linkage dimensions.

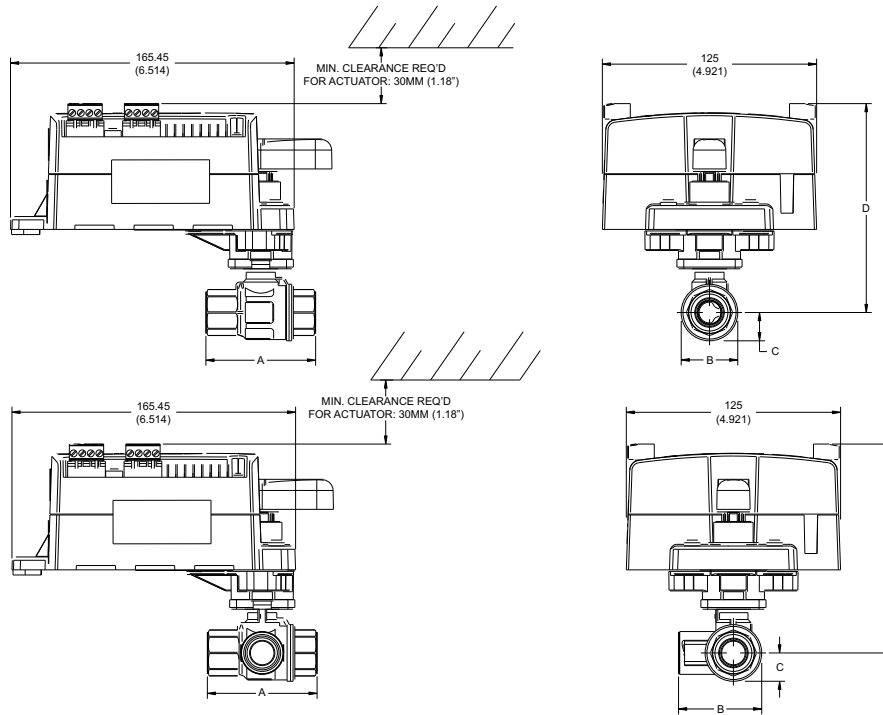

VMA1656 Actuated VG1241 and VG1841 Ball Valve with NPT End Connections Dimensions, in. (mm)

VMA1656 Actuated VG1241 and VG1841 Series Ball Valve with Optional M9000-551 Linkage Dimensions, in. (mm)

Valve Code Number	Valve Size, in. (DN) ¹	A	B	C	D
VG124XAX	1/2 (DN15)	2.52 (64)	1.34 (34)	0.67 (17)	4.80 (122)
VG124XBX	3/4 (DN20)	2.80 (71)	1.34 (34)	0.67 (17)	4.80 (122)
VG124XCX	3/4 (DN20)	3.43 (87)	1.50 (38)	0.75 (19)	4.88 (124)
VG184XAX	1/2 (DN15)	2.52 (64)	1.93 (49)	0.67 (17)	4.80 (122)
VG184XBX	3/4 (DN20)	2.80 (71)	2.09 (53)	0.67 (17)	4.80 (122)
VG184XCX	1 (DN25)	3.43 (87)	2.36 (60)	0.75 (19)	4.88 (124)

1. Port A must always be connected to the coil.

VG1000 Smart Ball Valves (Continued)

Technical Specifications

VG1000 Series Forged Brass Ball Valves

Service¹		Hot Water, Chilled Water, 50/50 Glycol Solutions
Fluid Temperature Limits	Water	VG12x1 and VG18x1 Series: 23 to 203°F (-5 to 95°C)
Maximum Actuator Fluid Temperature Limits	212°F (100°C)	VMA1656 Modular Assembly Controller Series
Valve Body Pressure/Temperature Rating	Water	580 psig (3,996 kPa) at 203°F (95°C) (PN40) 464 psig (3,196 kPa) at 284°F (140°C) (PN40)
Maximum Closeoff Pressure		200 psig (1,378 kPa)
Maximum Recommended Operating Pressure Drop		50 psig (340 kPa)
Flow Characteristics	Two-Way	Equal Percentage
	Three-Way	Equal Percentage Flow Characteristics of In-line Port A (Coil) and Linear Flow Characteristics of Angle Port B (Bypass)
Rangeability²		Greater than 500:1
Minimum Ambient Operating Temperature		32°F (0°C)
Maximum Ambient Operating Temperature³ (Limited by the Actuator and Linkage)		122°F (50°C): VMA1656 Series Non-Spring Return Actuators Modular Assembly Controller Series Direct Mount or With M9000-561 Thermal Barrier
Leakage		0.01% of Maximum Flow per ANSI/FCI 70-2, Class 4 (Two- and Three-Way Control Port) 1% of Maximum Flow for Three-Way Bypass Port
End Connections		National Pipe Thread (NPT): 1/2 to 1 in. (DN15 to DN25)
Materials	Body	Forged Brass
	Ball	Chrome Plated Brass
	Blowout-Proof Stem	Nickel Plated Brass
	Seats	Graphite-Reinforced PTFE with Ethylene Propylene Diene Monomer (EPDM) O-Ring Backing
	Stem Seals	EPDM Double O-Rings
	Characterizing Disk	Amodel AS-1145HS Polyphthalamide Resin

1. Proper water treatment is recommended; refer to the VDI 2035 Guideline.
2. Rangeability is defined as the ratio of maximum controllable flow to minimum controllable flow.
3. In steam applications, install the valve with the stem horizontal to the piping and wrap the valve and piping with insulation.

The performance specifications are nominal and conform to acceptable industry standards. For application at conditions beyond these specifications, consult the local Johnson Controls office. Johnson Controls, Inc. shall not be liable for damages resulting from misapplication or misuse of its products.



WARNING This product is made of copper alloy, which contains lead. The product is therefore not to be used on drinking water.



WARNING This product can expose you to chemicals including lead, which is known to the State of California to cause cancer, birth defects, or other reproductive harm. For more information, go to www.P65Warnings.ca.gov.

WARNING: BRASS MAY CONTAIN LEAD

To fulfill our obligations towards Article 33, in accordance to the European REACH Regulation No 1907/2006 EC, we hereby inform you that this article contains the following Substances of Very High Concern mentioned on the Candidate list:

- Lead

VG1000 Smart Ball Valves with FX-PCV Programmable VAV Box Controller Series

Description

VG1000 Series Ball Valves are designed to control the flow of hot or chilled water in HVAC systems. Available in sizes 1/2 through 1 in. (DN15 through DN25), this family of two- and three-way forged brass valves is factory or field mounted to Johnson Controls® FX-PCV Modular Assembly Controller Series. The controller allows for a customized response to environmental conditions and is particularly well suited for applications such as chilled beams and fan coils.

Features

- factory-mounted FX-PCV1656 programmable VAV box controller series
- forged brass body
- Amodel® flow characterizing disk
- 200 psi closeoff pressure rating
- chrome-plated brass ball and stem assembly standard
- 500:1 rangeability

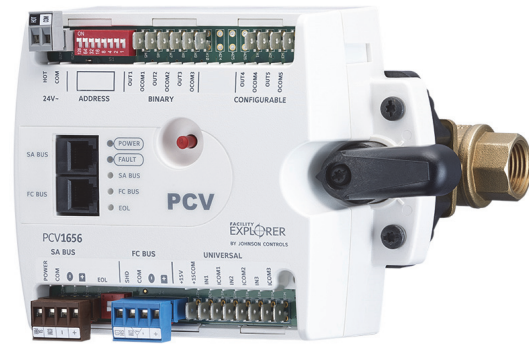

VG1000 Series Ball Valves Shown with FX-PCV1656 Programmable VAV Box Controller

Selection Chart

Ordering Data¹

V	Valve Global														
1	Product		1 = Forged Brass Ball Valve												
3	Family														
2	Body Type and Flow Characteristic		2 = Two-Way, with Equal Percentage Flow Characteristics												
4			8 = Three-Way Mixing, with Equal Percentage Flow Characteristics of In-line Port and Linear Flow Characteristics of Angle-Port												
4	End Connection		4 = Threaded - NPT Taper												
5															
1	Trim		1 = Chrome-Plated Brass Ball and Nickel-Plated Brass Stem												
6															
A	E	Size and Maximum Cv	Size	Control Disk	Control Port Cv (Kvs)	Bypass Port Cv (Kvs) (Three-Way Only)									
7	8	(Kvs = Cv x 0.857)	AD = 1/2 in. (DN15)	Yes	1.2 (1.0)	0.7 (0.6)									
			AE = 1/2 in. (DN15)	Yes	1.9 (1.6)	1.2 (1.0)									
			AF = 1/2 in. (DN15)	Yes	2.9 (2.5)	1.9 (1.6)									
			AG = 1/2 in. (DN15)	Yes	4.7 (4.0)	2.9 (2.5)									
			AL = 1/2 in. (DN15)	Yes	7.4 (6.3)	4.7 (4.0)									
			AN = 1/2 in. (DN15)	No	11.7 (10.0)	5.8 (5.0)									
			BG = 3/4 in. (DN20)	Yes	4.7 (4.0)	2.9 (2.5)									
			BL = 3/4 in. (DN20)	Yes	7.4 (6.3)	4.7 (4.0)									
			BN = 3/4 in. (DN20)	No	11.7 (10.0)	5.8 (5.0)									
			CL = 1 in. (DN25)	Yes	7.4 (6.3)	4.7 (4.0)									
			CN = 1 in. (DN25)	Yes	11.7 (10.0)	7.4 (6.3)									
			CP = 1 in. (DN25)	No	18.7 (16.0)	9.4 (8.0)									
+	Actuator		+ = Factory-Mounted Actuator												
9	Mounting		(Leave Fields 9 through 15 blank for valve without factory-mounted actuator.) H = High Temperature Linkage (VA9104, VA9203, and VA9208 actuators)												
1	2	3	4	5	6	7	8	9	10	11	12	13	14	15	= Field
V	G	1	2	4	1	A	E	+							
Valve								+	Actuator						

Example: Forged brass ball valve, two-way, threaded (NPT), brass trim, equal %, 1/2 in. (DN15) 1.9 Cv.

1. Before retrofitting older valves with FX-PCV1656 Modular Assembly Controller Series be sure that the valves have a tapped hole in the center of the valve stem and no threads in the flange holes. These direct mount actuators do not fit older valves designed without a tapped center stem hole or with threaded flange mounting holes.

VG1000 Smart Ball Valves with FX-PCV Programmable VAV Box Controller Series (Continued)

Shipping Weights, lb (kg) (Includes the FX-PCV)

Valve Code Number	Description	Shipping Weight, lb (kg)
VG12xxAx	1/2 in. (DN15) Two-Way Forged Brass Ball Valve	1.6 (0.7)
VG12xxBx	3/4 in. (DN20) Two-Way Forged Brass Ball Valve	1.6 (0.7)
VG12xxCx	1 in. (DN25) Two-Way Forged Brass Ball Valve	1.6 (0.7)
VG18xxAx	1/2 in. (DN15) Three-Way Forged Brass Ball Valve	1.6 (0.7)
VG18xxBx	3/4 in. (DN20) Three-Way Forged Brass Ball Valve	1.6 (0.7)
VG18xxCx	1 in. (DN25) Three-Way Forged Brass Ball Valve	1.6 (0.7)

Repair Parts

Linkage	Replacement Description	Replacement Part Code Number
M9000-551	Linkage with Handle for VA9104 Series Actuators and FX-PCV1656 Modular Assembly Controller Series	Unit Replacement
M9000-561	Thermal Barrier for VA9104/VA9203/VA9208 Series Actuators and FX-PCV1656 Modular Assembly Controller Series	Unit Replacement

See the figure below for dimension drawings of the FX-PCV1656, VG1241, and VG1841 Series NPT End Connection Ball Valves. See the table below for specific model linkage dimensions.

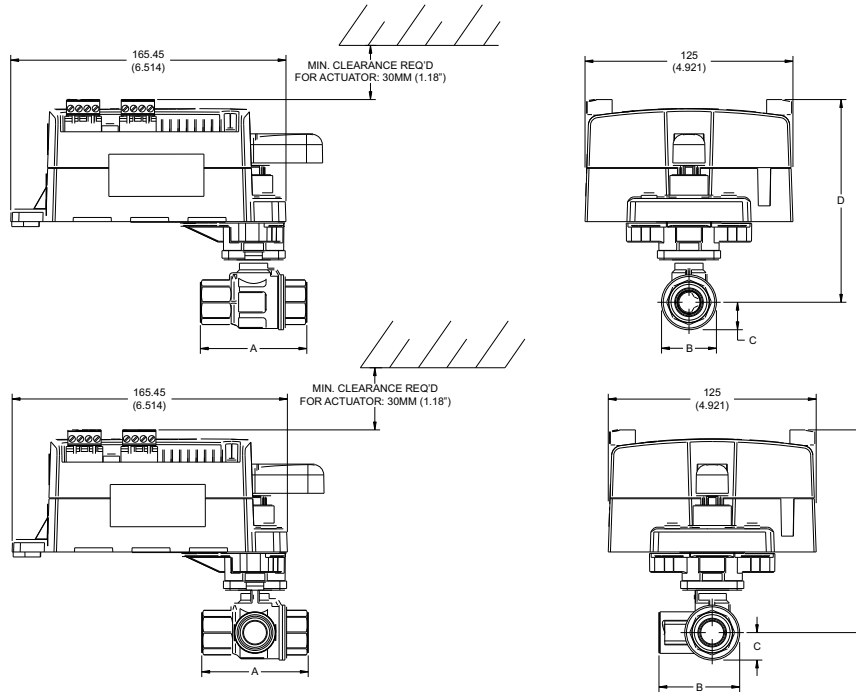

FX-PCV1656 Actuated VG1241 and VG1841 Ball Valve with NPT End Connections Dimensions, in. (mm)

FX-PCV1656 Actuated VG1241 and VG1841 Series Ball Valve with Optional M9000-551 Linkage Dimensions, in. (mm)

Valve Code Number	Valve Size, in. (DN) ¹	A	B	C	D
VG124XAX	1/2 (DN15)	2.52 (64)	1.34 (34)	0.67 (17)	4.80 (122)
VG124XBX	3/4 (DN20)	2.80 (71)	1.34 (34)	0.67 (17)	4.80 (122)
VG124XCX	3/4 (DN20)	3.43 (87)	1.50 (38)	0.75 (19)	4.88 (124)
VG184XAX	1/2 (DN15)	2.52 (64)	1.93 (49)	0.67 (17)	4.80 (122)
VG184XBX	3/4 (DN20)	2.80 (71)	2.09 (53)	0.67 (17)	4.80 (122)
VG184XCX	1 (DN25)	3.43 (87)	2.36 (60)	0.75 (19)	4.88 (124)

1. Port A must always be connected to the coil.

VG1000 Smart Ball Valves with FX-PCV Programmable VAV Box Controller Series (Continued)

Technical Specifications

VG1000 Series Forged Brass Ball Valves

Service¹		Hot Water, Chilled Water, 50/50 Glycol Solutions
Fluid Temperature Limits	Water	VG12x1 and VG18x1 Series: 23 to 203°F (-5 to 95°C)
Maximum Actuator Fluid Temperature Limits	212°F (100°C)	FX-PCV1656 Programmable VAV Box Controller Series
Valve Body Pressure/Temperature Rating	Water	580 psig (3,996 kPa) at 203°F (95°C) (PN40) 464 psig (3,196 kPa) at 284°F (140°C) (PN40)
Maximum Closeoff Pressure		200 psig (1,378 kPa)
Maximum Recommended Operating Pressure Drop		50 psig (340 kPa)
Flow Characteristics	Two-Way	Equal Percentage
	Three-Way	Equal Percentage Flow Characteristics of In-line Port A (Coil) and Linear Flow Characteristics of Angle Port B (Bypass)
Rangeability²		Greater than 500:1
Minimum Ambient Operating Temperature		32°F (0°C)
Maximum Ambient Operating Temperature³ (Limited by the Actuator and Linkage)		122°F (50°C): FX-PCV1656 Series Non-Spring Return Actuators Modular Assembly Controller Series Direct Mount or With M9000-561 Thermal Barrier
Leakage		0.01% of Maximum Flow per ANSI/FCI 70-2, Class 4 (Two- and Three-Way Control Port) 1% of Maximum Flow for Three-Way Bypass Port
End Connections		National Pipe Thread (NPT): 1/2 to 1 in. (DN15 to DN25)
Materials	Body	Forged Brass
	Ball	Chrome Plated Brass
	Blowout-Proof Stem	Nickel Plated Brass
	Seats	Graphite-Reinforced PTFE with Ethylene Propylene Diene Monomer (EPDM) O-Ring Backing
	Stem Seals	EPDM Double O-Rings
	Characterizing Disk	Amodel AS-1145HS Polyphthalamide Resin

1. Proper water treatment is recommended; refer to the VDI 2035 Guideline.
2. Rangeability is defined as the ratio of maximum controllable flow to minimum controllable flow.
3. In steam applications, install the valve with the stem horizontal to the piping and wrap the valve and piping with insulation.

The performance specifications are nominal and conform to acceptable industry standards. For application at conditions beyond these specifications, consult the local Johnson Controls office. Johnson Controls shall not be liable for damages resulting from misapplication or misuse of its products.



WARNING This product is made of copper alloy, which contains lead. The product is therefore not to be used on drinking water.



WARNING This product can expose you to chemicals including lead, which is known to the State of California to cause cancer, birth defects, or other reproductive harm. For more information, go to www.P65Warnings.ca.gov.

WARNING: BRASS MAY CONTAIN LEAD

To fulfill our obligations towards Article 33, in accordance to the European REACH Regulation No 1907/2006 EC, we hereby inform you that this article contains the following Substances of Very High Concern mentioned on the Candidate list:

- Lead

VG1000 Series Sweat End Connection Plated Brass Trim Ball Valves

Description

VG1000 Series Ball Valves are designed to regulate the flow of hot or chilled water and, for some models, low-pressure steam in response to the demand of a controller in HVAC systems. Available in sizes 1/2 through 1 in. (DN15 through DN25), this family of two- and three-way forged brass valves is factory or field mounted to Johnson Controls® VA9104 Series Non-Spring-Return and VA9203 Series Spring-Return Electric Actuators for on/off, floating, or proportional control. When supplied with an actuator, the actuator is not mounted to the valve to allow access to the end connections.

Refer to the *VG1000 Series Forged Brass Ball Valves Product Bulletin (LIT-977132)* for important product application information.

Features

- Forged Brass Body — provides 300 psig static pressure rating.
- Graphite-Reinforced Polytetrafluoroethylene (PTFE) Seats — include 15% graphite-reinforced ball seals, providing better wear resistance.
- 500:1 Rangeability — provides accurate control under all load conditions.
- Maintenance-Free Design — performs without failure in excess of 200,000 full stroke cycles in iron-oxide contaminated water.



VG1000 Series Sweat End Connection Valves

WARNING

This product can expose you to chemicals including lead, which is known to the State of California to cause cancer, birth defects, or other reproductive harm. For more information, go to www.P65Warnings.ca.gov.

Selection Charts

VG1000 Sweat End Connection Valves, Brass Trim, Non-Spring-Return Actuators with M3 Screw Terminal

Valve Code Number	Size, in.	Cv (Control Port) / Cv (Bypass Port)	Closeoff psig	AC 24 V		
				On/Off (Floating) without Timeout ¹	On/Off (Floating) with Timeout	DC 0 to 10 V Proportional
				VA9104-AGA-3S ²	VA9104-IGA-3S ²	VA9104-GGA-3S ²
Two-Way						
VG1271AD	1/2	1.2 ³	200	VG1271AD+9T4AGA	VG1271AD+9T4IGA	VG1271AD+9T4GGA
VG1271AE		1.9 ³		VG1271AE+9T4AGA	VG1271AE+9T4IGA	VG1271AE+9T4GGA
VG1271AF		2.9 ³		VG1271AF+9T4AGA	VG1271AF+9T4IGA	VG1271AF+9T4GGA
VG1271AG		4.7 ³		VG1271AG+9T4AGA	VG1271AG+9T4IGA	VG1271AG+9T4GGA
VG1271AL		7.4 ³		VG1271AL+9T4AGA	VG1271AL+9T4IGA	VG1271AL+9T4GGA
VG1271AN		11.7		VG1271AN+9T4AGA	VG1271AN+9T4IGA	VG1271AN+9T4GGA
VG1271BG	3/4	4.7 ³	200	VG1271BG+9T4AGA	VG1271BG+9T4IGA	VG1271BG+9T4GGA
VG1271BL		7.4 ³		VG1271BL+9T4AGA	VG1271BL+9T4IGA	VG1271BL+9T4GGA
VG1271BN		11.7		VG1271BN+9T4AGA	VG1271BN+9T4IGA	VG1271BN+9T4GGA
VG1271CL	1	7.4 ³	200	VG1271CL+9T4AGA	VG1271CL+9T4IGA	VG1271CL+9T4GGA
VG1271CN		11.7 ³		VG1271CN+9T4AGA	VG1271CN+9T4IGA	VG1271CN+9T4GGA
VG1271CP		18.7		VG1271CP+9T4AGA	VG1271CP+9T4IGA	VG1271CP+9T4GGA
Three-Way						
VG1871AD	1/2	1.2 ³	200	VG1871AD+9T4AGA	VG1871AD+9T4IGA	VG1871AD+9T4GGA
VG1871AE		1.9 ³		VG1871AE+9T4AGA	VG1871AE+9T4IGA	VG1871AE+9T4GGA
VG1871AF		2.9 ³		VG1871AF+9T4AGA	VG1871AF+9T4IGA	VG1871AF+9T4GGA
VG1871AG		4.7 ³		VG1871AG+9T4AGA	VG1871AG+9T4IGA	VG1871AG+9T4GGA
VG1871AL		7.4 ³		VG1871AL+9T4AGA	VG1871AL+9T4IGA	VG1871AL+9T4GGA
VG1871AN		11.7		VG1871AN+9T4AGA	VG1871AN+9T4IGA	VG1871AN+9T4GGA
VG1871BG	3/4	4.7 ³	200	VG1871BG+9T4AGA	VG1871BG+9T4IGA	VG1871BG+9T4GGA
VG1871BL		7.4 ³		VG1871BL+9T4AGA	VG1871BL+9T4IGA	VG1871BL+9T4GGA
VG1871BN		11.7		VG1871BN+9T4AGA	VG1871BN+9T4IGA	VG1871BN+9T4GGA
VG1871CL	1	7.4 ³	200	VG1871CL+9T4AGA	VG1871CL+9T4IGA	VG1871CL+9T4GGA
VG1871CN		11.7 ³		VG1871CN+9T4AGA	VG1871CN+9T4IGA	VG1871CN+9T4GGA
VG1871CP		18.7		VG1871CP+9T4AGA	VG1871CP+9T4IGA	VG1871CP+9T4GGA

1. To avoid excessive wear or drive time on the motor for the AGx models, use a controller or software that provides a timeout function to remove the signal at the end of rotation (stall).
2. Code numbers shown are for a VA9104-xGA-3S actuator with M3 screw terminals. To specify a 48-in. plenum rated cable, change the 9T4 to 9A4 in the code number for a VA9104-xGA-2S actuator. Example: VG1241AD+9T4AGA becomes VG1241AD+9A4AGA.
3. Valve has a characterizing disk.

VG1000 Series Sweat End Connection Plated Brass Trim Ball Valves (Continued)

VG1000 Sweat End Connection Valves, Brass Trim, Spring-Return Actuators (Part 1 of 2)

Valve Code Number	Size, in.	Cv (Control Port) / Cv (Bypass Port)	Closeoff psig	AC 24 V			AC 120 V
				Floating	DC 0 to 10 V Proportional	On/Off	On/Off
				VA9203-AGA-2Z	VA9203-GGA-2Z	VA9203-BGA-2	VA9203-BUA-2
Two-Way Spring Return Valve Open (Normally Open)							
VG1271AD	1/2	1.2 ¹	200	VG1271AD+923AGA	VG1271AD+923GGA	VG1271AD+923BGA	VG1271AD+923BUA
VG1271AE		1.9 ¹		VG1271AE+923AGA	VG1271AE+923GGA	VG1271AE+923BGA	VG1271AE+923BUA
VG1271AF		2.9 ¹		VG1271AF+923AGA	VG1271AF+923GGA	VG1271AF+923BGA	VG1271AF+923BUA
VG1271AG		4.7 ¹		VG1271AG+923AGA	VG1271AG+923GGA	VG1271AG+923BGA	VG1271AG+923BUA
VG1271AL		7.4 ¹		VG1271AL+923AGA	VG1271AL+923GGA	VG1271AL+923BGA	VG1271AL+923BUA
VG1271AN		11.7		VG1271AN+923AGA	VG1271AN+923GGA	VG1271AN+923BGA	VG1271AN+923BUA
VG1271BG	3/4	4.7 ¹	200	VG1271BG+923AGA	VG1271BG+923GGA	VG1271BG+923BGA	VG1271BG+923BUA
VG1271BL		7.4 ¹		VG1271BL+923AGA	VG1271BL+923GGA	VG1271BL+923BGA	VG1271BL+923BUA
VG1271BN		11.7		VG1271BN+923AGA	VG1271BN+923GGA	VG1271BN+923BGA	VG1271BN+923BUA
VG1271CL	1	7.4 ¹	200	VG1271CL+923AGA	VG1271CL+923GGA	VG1271CL+923BGA	VG1271CL+923BUA
VG1271CN		11.7 ¹		VG1271CN+923AGA	VG1271CN+923GGA	VG1271CN+923BGA	VG1271CN+923BUA
VG1271CP		18.7		VG1271CP+923AGA	VG1271CP+923GGA	VG1271CP+923BGA	VG1271CP+923BUA
Two-Way Spring Return Valve Closed (Normally Closed)							
VG1271AD	1/2	1.2 ¹	200	VG1271AD+943AGA	VG1271AD+943GGA	VG1271AD+943BGA	VG1271AD+943BUA
VG1271AE		1.9 ¹		VG1271AE+943AGA	VG1271AE+943GGA	VG1271AE+943BGA	VG1271AE+943BUA
VG1271AF		2.9 ¹		VG1271AF+943AGA	VG1271AF+943GGA	VG1271AF+943BGA	VG1271AF+943BUA
VG1271AG		4.7 ¹		VG1271AG+943AGA	VG1271AG+943GGA	VG1271AG+943BGA	VG1271AG+943BUA
VG1271AL		7.4 ¹		VG1271AL+943AGA	VG1271AL+943GGA	VG1271AL+943BGA	VG1271AL+943BUA
VG1271AN		11.7		VG1271AN+943AGA	VG1271AN+943GGA	VG1271AN+943BGA	VG1271AN+943BUA
VG1271BG	3/4	4.7 ¹	200	VG1271BG+943AGA	VG1271BG+943GGA	VG1271BG+943BGA	VG1271BG+943BUA
VG1271BL		7.4 ¹		VG1271BL+943AGA	VG1271BL+943GGA	VG1271BL+943BGA	VG1271BL+943BUA
VG1271BN		11.7		VG1271BN+943AGA	VG1271BN+943GGA	VG1271BN+943BGA	VG1271BN+943BUA
VG1271CL	1	7.4 ¹	200	VG1271CL+943AGA	VG1271CL+943GGA	VG1271CL+943BGA	VG1271CL+943BUA
VG1271CN		11.7 ¹		VG1271CN+943AGA	VG1271CN+943GGA	VG1271CN+943BGA	VG1271CN+943BUA
VG1271CP		18.7		VG1271CP+943AGA	VG1271CP+943GGA	VG1271CP+943BGA	VG1271CP+943BUA
Three-Way Spring Return Counterclockwise, Port A (Coil) Open							
VG1871AD	1/2	1.2 ¹	200	VG1871AD+923AGA	VG1871AD+923GGA	VG1871AD+923BGA	VG1871AD+923BUA
VG1871AE		1.9 ¹		VG1871AE+923AGA	VG1871AE+923GGA	VG1871AE+923BGA	VG1871AE+923BUA
VG1871AF		2.9 ¹		VG1871AF+923AGA	VG1871AF+923GGA	VG1871AF+923BGA	VG1871AF+923BUA
VG1871AG		4.7 ¹		VG1871AG+923AGA	VG1871AG+923GGA	VG1871AG+923BGA	VG1871AG+923BUA
VG1871AL		7.4 ¹		VG1871AL+923AGA	VG1871AL+923GGA	VG1871AL+923BGA	VG1871AL+923BUA
VG1871AN		11.7		VG1871AN+923AGA	VG1871AN+923GGA	VG1871AN+923BGA	VG1871AN+923BUA
VG1871BG	3/4	4.7 ¹	200	VG1871BG+923AGA	VG1871BG+923GGA	VG1871BG+923BGA	VG1871BG+923BUA
VG1871BL		7.4 ¹		VG1871BL+923AGA	VG1871BL+923GGA	VG1871BL+923BGA	VG1871BL+923BUA
VG1871BN		11.7		VG1871BN+923AGA	VG1871BN+923GGA	VG1871BN+923BGA	VG1871BN+923BUA
VG1871CL	1	7.4 ¹	200	VG1871CL+923AGA	VG1871CL+923GGA	VG1871CL+923BGA	VG1871CL+923BUA
VG1871CN		11.7 ¹		VG1871CN+923AGA	VG1871CN+923GGA	VG1871CN+923BGA	VG1871CN+923BUA
VG1871CP		18.7		VG1871CP+923AGA	VG1871CP+923GGA	VG1871CP+923BGA	VG1871CP+923BUA



This product is made of copper alloy, which contains lead. The product is therefore not to be used on drinking water.

WARNING: BRASS MAY CONTAIN LEAD

To fulfill our obligations towards Article 33, in accordance to the European REACH Regulation No 1907/2006 EC, we hereby inform you that this article contains the following Substances of Very High Concern mentioned on the Candidate list:

- Lead

VG1000 Series Sweat End Connection Plated Brass Trim Ball Valves (Continued)

VG1000 Sweat End Connection Valves, Brass Trim, Spring-Return Actuators (Part 2 of 2)

Valve Code Number	Size, in.	Cv (Control Port) / Cv (Bypass Port)	Closeoff psig	AC 24 V			AC 120 V
				Floating	DC 0 to 10 V Proportional	On/Off	On/Off
				VA9203-AGA-2Z	VA9203-GGA-2Z	VA9203-BGA-2	VA9203-BUA-2
Three-Way Spring Return Clockwise, Port B (Bypass) Open							
VG1871AD	1/2	1.2 ¹	200	VG1871AD+943AGA	VG1871AD+943GGA	VG1871AD+943BGA	VG1871AD+943BUA
VG1871AE		1.9 ¹		VG1871AE+943AGA	VG1871AE+943GGA	VG1871AE+943BGA	VG1871AE+943BUA
VG1871AF		2.9 ¹		VG1871AF+943AGA	VG1871AF+943GGA	VG1871AF+943BGA	VG1871AF+943BUA
VG1871AG		4.7 ¹		VG1871AG+943AGA	VG1871AG+943GGA	VG1871AG+943BGA	VG1871AG+943BUA
VG1871AL		7.4 ¹		VG1871AL+943AGA	VG1871AL+943GGA	VG1871AL+943BGA	VG1871AL+943BUA
VG1871AN		11.7		VG1871AN+943AGA	VG1871AN+943GGA	VG1871AN+943BGA	VG1871AN+943BUA
VG1871BG	3/4	4.7 ¹	200	VG1871BG+943AGA	VG1871BG+943GGA	VG1871BG+943BGA	VG1871BG+943BUA
VG1871BL		7.4 ¹		VG1871BL+943AGA	VG1871BL+943GGA	VG1871BL+943BGA	VG1871BL+943BUA
VG1871BN		11.7		VG1871BN+943AGA	VG1871BN+943GGA	VG1871BN+943BGA	VG1871BN+943BUA
VG1871CL	1	7.4 ¹	200	VG1871CL+943AGA	VG1871CL+943GGA	VG1871CL+943BGA	VG1871CL+943BUA
VG1871CN		11.7 ¹		VG1871CN+943AGA	VG1871CN+943GGA	VG1871CN+943BGA	VG1871CN+943BUA
VG1871CP		18.7		VG1871CP+943AGA	VG1871CP+943GGA	VG1871CP+943BGA	VG1871CP+943BUA

1. Valve has a characterizing disk.

Accessories and Repair Parts

Linkage	Replacement Description
M9000-551	Ball Valve Linkage Kit with Handle for M9104 Series Actuators
M9000-560	Ball Valve Linkage Kit for M9203 Series Actuators

Technical Specifications

VG1000 Series Sweat End Connection Plated Brass Trim Ball Valves		
Service ¹	Hot Water, Chilled Water, and 50/50 Glycol Solutions for HVAC Systems	
Fluid Temperature Limits	23°F to 203°F (-5°C to 95°C)	
Valve Body Pressure Rating	300 psig, PN40	
Maximum Closeoff Pressure	200 psid (1,378 kPa)	
Maximum Recommended Operating Pressure Drop	50 psid (340 kPa)	
Flow Characteristics	Two-Way	Equal Percentage
	Three-Way	Equal Percentage Flow Characteristics on the In-Line Port A (Coil) and Linear Flow Characteristics of the Angle Port B (Bypass)
Rangeability ²	Greater than 500:1	
Minimum Ambient Operating Temperature	With VA9203 Series Spring-Return Actuators	-22°F (-30°C)
	With VA9104 Series Non-Spring-Return Actuators	-4°F (-20°C)
Maximum Ambient Operating Temperature	With VA9203 Series Spring-Return Actuators	122°F (50°C)
	With VA9104 Series Non-Spring-Return Actuators	140°F (60°C)
Leakage	0.01% of Maximum Flow per ANSI/FCI 70-2, Class 4	
End Connections	Sweat Note: Use a Low Melting Point Solder.	
Materials	Body	Forged Brass
	Ball	Chrome Plated Brass
	Blowout Proof Stem	Nickel Plated Brass
	Seats	Graphite-Reinforced PTFE with Ethylene Propylene Diene Monomer (EPDM) O-Ring Backing
	Stem Seals	EPDM Double O-Rings
	Characterizing Disk	Amodel® AS-1145HS Polyphthalamide Resin

1. Proper water treatment is recommended; refer to the VDI 2035 Guideline.

2. Rangeability is defined as the ratio of maximum controllable flow to minimum controllable flow.

VG1000 Series Sweat End Connection Stainless Steel Trim Ball Valves

Description

VG1000 Series Ball Valves are designed to regulate the flow of hot or chilled water and, for some models, low-pressure steam in response to the demand of a controller in HVAC systems. Available with Sweat End Connections in sizes 1/2 through 1 in. (DN15 through DN25), this family of two- and three-way forged brass valves is factory or field mounted to Johnson Controls® VA9104 Series Non-Spring-Return and VA9203 Series Spring-Return Electric Actuators for on/off, floating, or proportional control. When supplied with an actuator, the actuator is not mounted to the valve to allow access to the end connections for brazing.

Refer to the *VG1000 Series Forged Brass Ball Valves Product Bulletin (LIT-977132)* for important product application information.

Features

- Forged Brass Body — provides 300 psig static pressure rating.
- Graphite-Reinforced Polytetrafluoroethylene (PTFE) Seats — include 15% graphite-reinforced ball seals, providing better wear resistance.
- 500:1 Rangeability — provides accurate control under all load conditions.
- Maintenance-Free Design — performs without failure in excess of 200,000 full stroke cycles in iron-oxide contaminated water.



VG1000 Series Sweat End Connection Valves

WARNING

This product can expose you to chemicals including lead, which is known to the State of California to cause cancer, birth defects, or other reproductive harm. For more information, go to www.P65Warnings.ca.gov.

Selection Charts

VG1000 Sweat End Connection Valves, Stainless Steel Trim, Non-Spring-Return Actuators with M3 Screw Terminal

Valve Code Number	Size, in.	Cv (Control Port) / Cv (Bypass Port)	Closeoff psig	AC 24 V		
				On/Off (Floating) without Timeout ¹	On/Off (Floating) with Timeout	DC 0 to 10 V Proportional
				VA9104-AGA-3S ²	VA9104-IGA-3S ²	VA9104-GGA-3S ²
Two-Way						
VG1275AD	1/2	1.2 ³	200	VG1275AD+9T4AGA	VG1275AD+9T4IGA	VG1275AD+9T4GGA
VG1275AE		1.9 ³		VG1275AE+9T4AGA	VG1275AE+9T4IGA	VG1275AE+9T4GGA
VG1275AF		2.9 ³		VG1275AF+9T4AGA	VG1275AF+9T4IGA	VG1275AF+9T4GGA
VG1275AG		4.7 ³		VG1275AG+9T4AGA	VG1275AG+9T4IGA	VG1275AG+9T4GGA
VG1275AL		7.4 ³		VG1275AL+9T4AGA	VG1275AL+9T4IGA	VG1275AL+9T4GGA
VG1275AN		11.7		VG1275AN+9T4AGA	VG1275AN+9T4IGA	VG1275AN+9T4GGA
VG1275BG	3/4	4.7 ³	200	VG1275BG+9T4AGA	VG1275BG+9T4IGA	VG1275BG+9T4GGA
VG1275BL		7.4 ³		VG1275BL+9T4AGA	VG1275BL+9T4IGA	VG1275BL+9T4GGA
VG1275BN		11.7		VG1275BN+9T4AGA	VG1275BN+9T4IGA	VG1275BN+9T4GGA
VG1275CL	1	7.4 ³	200	VG1275CL+9T4AGA	VG1275CL+9T4IGA	VG1275CL+9T4GGA
VG1275CN		11.7 ³		VG1275CN+9T4AGA	VG1275CN+9T4IGA	VG1275CN+9T4GGA
VG1275CP		18.7		VG1275CP+9T4AGA	VG1275CP+9T4IGA	VG1275CP+9T4GGA
Three-Way						
VG1875AD	1/2	1.2/0.7 ³	200	VG1875AD+9T4AGA	VG1875AD+9T4IGA	VG1875AD+9T4GGA
VG1875AE		1.9/1.2 ³		VG1875AE+9T4AGA	VG1875AE+9T4IGA	VG1875AE+9T4GGA
VG1875AF		2.9/1.9 ³		VG1875AF+9T4AGA	VG1875AF+9T4IGA	VG1875AF+9T4GGA
VG1875AG		4.7/2.9 ³		VG1875AG+9T4AGA	VG1875AG+9T4IGA	VG1875AG+9T4GGA
VG1875AL		7.4/4.7 ³		VG1875AL+9T4AGA	VG1875AL+9T4IGA	VG1875AL+9T4GGA
VG1875AN		11.7/5.8		VG1875AN+9T4AGA	VG1875AN+9T4IGA	VG1875AN+9T4GGA
VG1875BG	3/4	4.7/2.9 ³	200	VG1875BG+9T4AGA	VG1875BG+9T4IGA	VG1875BG+9T4GGA
VG1875BL		7.4/4.7 ³		VG1875BL+9T4AGA	VG1875BL+9T4IGA	VG1875BL+9T4GGA
VG1875BN		11.7/5.8		VG1875BN+9T4AGA	VG1875BN+9T4IGA	VG1875BN+9T4GGA
VG1875CL	1	7.4/4.7 ³	200	VG1875CL+9T4AGA	VG1875CL+9T4IGA	VG1875CL+9T4GGA
VG1875CN		11.7/7.4 ³		VG1875CN+9T4AGA	VG1875CN+9T4IGA	VG1875CN+9T4GGA
VG1875CP		18.7/9.4		VG1875CP+9T4AGA	VG1875CP+9T4IGA	VG1875CP+9T4GGA

1. To avoid excessive wear or drive time on the motor for the AGx models, use a controller or software that provides a timeout function to remove the signal at the end of rotation (stall).
2. Code numbers shown are for a VA9104-xGA-3S actuator with M3 screw terminals. To specify a 120-in. plenum rated cable, change 9T4 to 9A4 in the code number for a VA9104-xGA-2S actuator. For example, VG1241AD+9T4AGA becomes VG1241AD+9A4AGA.
3. Valve has a characterizing disk.

VG1000 Series Sweat End Connection Stainless Steel Trim Ball Valves (Continued)

VG1000 Sweat End Connection Valves, Stainless Steel Trim, Spring-Return Actuators (Part 1 of 2)

Valve Code Number	Size, in.	Cv (Control Port) / Cv (Bypass Port)	Closeoff psig	AC 24 V			AC 85-264 V
				Floating	DC 0 to 10 V Proportional	On/Off	On/Off
				VA9203-AGA-2Z	VA9203-GGA-2Z	VA9203-BGA-2	VA9203-BUA-2
Two-Way Spring Return Valve Open (Normally Open)							
VG1275AD	1/2	1.2 ¹	200	VG1275AD+923AGA	VG1275AD+923GGA	VG1275AD+923BGA	VG1275AD+923BUA
VG1275AE		1.9 ¹		VG1275AE+923AGA	VG1275AE+923GGA	VG1275AE+923BGA	VG1275AE+923BUA
VG1275AF		2.9 ¹		VG1275AF+923AGA	VG1275AF+923GGA	VG1275AF+923BGA	VG1275AF+923BUA
VG1275AG		4.7 ¹		VG1275AG+923AGA	VG1275AG+923GGA	VG1275AG+923BGA	VG1275AG+923BUA
VG1275AL		7.4 ¹		VG1275AL+923AGA	VG1275AL+923GGA	VG1275AL+923BGA	VG1275AL+923BUA
VG1275AN		11.7		VG1275AN+923AGA	VG1275AN+923GGA	VG1275AN+923BGA	VG1275AN+923BUA
VG1275BG	3/4	4.7 ¹	200	VG1275BG+923AGA	VG1275BG+923GGA	VG1275BG+923BGA	VG1275BG+923BUA
VG1275BL		7.4 ¹		VG1275BL+923AGA	VG1275BL+923GGA	VG1275BL+923BGA	VG1275BL+923BUA
VG1275BN		11.7		VG1275BN+923AGA	VG1275BN+923GGA	VG1275BN+923BGA	VG1275BN+923BUA
VG1275CL	1	7.4 ¹	200	VG1275CL+923AGA	VG1275CL+923GGA	VG1275CL+923BGA	VG1275CL+923BUA
VG1275CN		11.7 ¹		VG1275CN+923AGA	VG1275CN+923GGA	VG1275CN+923BGA	VG1275CN+923BUA
VG1275CP		18.7		VG1275CP+923AGA	VG1275CP+923GGA	VG1275CP+923BGA	VG1275CP+923BUA
Two-Way Spring Return Valve Closed (Normally Closed)							
VG1275AD	1/2	1.2 ¹	200	VG1275AD+943AGA	VG1275AD+943GGA	VG1275AD+943BGA	VG1275AD+943BUA
VG1275AE		1.9 ¹		VG1275AE+943AGA	VG1275AE+943GGA	VG1275AE+943BGA	VG1275AE+943BUA
VG1275AF		2.9 ¹		VG1275AF+943AGA	VG1275AF+943GGA	VG1275AF+943BGA	VG1275AF+943BUA
VG1275AG		4.7 ¹		VG1275AG+943AGA	VG1275AG+943GGA	VG1275AG+943BGA	VG1275AG+943BUA
VG1275AL		7.4 ¹		VG1275AL+943AGA	VG1275AL+943GGA	VG1275AL+943BGA	VG1275AL+943BUA
VG1275AN		11.7		VG1275AN+943AGA	VG1275AN+943GGA	VG1275AN+943BGA	VG1275AN+943BUA
VG1275BG	3/4	4.7 ¹	200	VG1275BG+943AGA	VG1275BG+943GGA	VG1275BG+943BGA	VG1275BG+943BUA
VG1275BL		7.4 ¹		VG1275BL+943AGA	VG1275BL+943GGA	VG1275BL+943BGA	VG1275BL+943BUA
VG1275BN		11.7		VG1275BN+943AGA	VG1275BN+943GGA	VG1275BN+943BGA	VG1275BN+943BUA
VG1275CL	1	7.4 ¹	200	VG1275CL+943AGA	VG1275CL+943GGA	VG1275CL+943BGA	VG1275CL+943BUA
VG1275CN		11.7 ¹		VG1275CN+943AGA	VG1275CN+943GGA	VG1275CN+943BGA	VG1275CN+943BUA
VG1275CP		18.7		VG1275CP+943AGA	VG1275CP+943GGA	VG1275CP+943BGA	VG1275CP+943BUA
Three-Way Spring Return Counterclockwise, Port A (Coil) Open							
VG1875AD	1/2	1.2/0.7 ¹	200	VG1875AD+923AGA	VG1875AD+923GGA	VG1875AD+923BGA	VG1875AD+923BUA
VG1875AE		1.9/1.2 ¹		VG1875AE+923AGA	VG1875AE+923GGA	VG1875AE+923BGA	VG1875AE+923BUA
VG1875AF		2.9/1.9 ¹		VG1875AF+923AGA	VG1875AF+923GGA	VG1875AF+923BGA	VG1875AF+923BUA
VG1875AG		4.7/2.9 ¹		VG1875AG+923AGA	VG1875AG+923GGA	VG1875AG+923BGA	VG1875AG+923BUA
VG1875AL		7.4/4.7 ¹		VG1875AL+923AGA	VG1875AL+923GGA	VG1875AL+923BGA	VG1875AL+923BUA
VG1875AN		11.7/5.8		VG1875AN+923AGA	VG1875AN+923GGA	VG1875AN+923BGA	VG1875AN+923BUA
VG1875BG	3/4	4.7/2.9 ¹	200	VG1875BG+923AGA	VG1875BG+923GGA	VG1875BG+923BGA	VG1875BG+923BUA
VG1875BL		7.4/4.7 ¹		VG1875BL+923AGA	VG1875BL+923GGA	VG1875BL+923BGA	VG1875BL+923BUA
VG1875BN		11.7/5.8		VG1875BN+923AGA	VG1875BN+923GGA	VG1875BN+923BGA	VG1875BN+923BUA
VG1875CL	1	7.4/4.7 ¹	200	VG1875CL+923AGA	VG1875CL+923GGA	VG1875CL+923BGA	VG1875CL+923BUA
VG1875CN		11.7/7.4 ¹		VG1875CN+923AGA	VG1875CN+923GGA	VG1875CN+923BGA	VG1875CN+923BUA
VG1875CP		18.7/9.4		VG1875CP+923AGA	VG1875CP+923GGA	VG1875CP+923BGA	VG1875CP+923BUA



This product is made of copper alloy, which contains lead. The product is therefore not to be used on drinking water.

WARNING: BRASS MAY CONTAIN LEAD

To fulfill our obligations towards Article 33, in accordance to the European REACH Regulation No 1907/2006 EC, we hereby inform you that this article contains the following Substances of Very High Concern mentioned on the Candidate list:

- Lead

VG1000 Series Sweat End Connection Stainless Steel Trim Ball Valves (Continued)

VG1000 Sweat End Connection Valves, Stainless Steel Trim, Spring-Return Actuators (Part 2 of 2)

Valve Code Number	Size, in.	Cv (Control Port) / Cv (Bypass Port)	Closeoff psig	AC 24 V			AC 85-264 V
				Floating	DC 0 to 10 V Proportional	On/Off	On/Off
				VA9203-AGA-2Z	VA9203-GGA-2Z	VA9203-BGA-2	VA9203-BUA-2
Three-Way Spring Return Clockwise, Port B (Bypass) Open							
VG1875AD	1/2	1.2/0.7 ¹	200	VG1875AD+943AGA	VG1875AD+943GGA	VG1875AD+943BGA	VG1875AD+943BUA
VG1875AE		1.9/1.2 ¹		VG1875AE+943AGA	VG1875AE+943GGA	VG1875AE+943BGA	VG1875AE+943BUA
VG1875AF		2.9/1.9 ¹		VG1875AF+943AGA	VG1875AF+943GGA	VG1875AF+943BGA	VG1875AF+943BUA
VG1875AG		4.7/2.9 ¹		VG1875AG+943AGA	VG1875AG+943GGA	VG1875AG+943BGA	VG1875AG+943BUA
VG1875AL		7.4/4.7 ¹		VG1875AL+943AGA	VG1875AL+943GGA	VG1875AL+943BGA	VG1875AL+943BUA
VG1875AN		11.7/5.8		VG1875AN+943AGA	VG1875AN+943GGA	VG1875AN+943BGA	VG1875AN+943BUA
VG1875BG	3/4	4.7/2.9 ¹	200	VG1875BG+943AGA	VG1875BG+943GGA	VG1875BG+943BGA	VG1875BG+943BUA
VG1875BL		7.4/4.7 ¹		VG1875BL+943AGA	VG1875BL+943GGA	VG1875BL+943BGA	VG1875BL+943BUA
VG1875BN		11.7/5.8		VG1875BN+943AGA	VG1875BN+943GGA	VG1875BN+943BGA	VG1875BN+943BUA
VG1875CL	1	7.4/4.7 ¹	200	VG1875CL+943AGA	VG1875CL+943GGA	VG1875CL+943BGA	VG1875CL+943BUA
VG1875CN		11.7/7.4 ¹		VG1875CN+943AGA	VG1875CN+943GGA	VG1875CN+943BGA	VG1875CN+943BUA
VG1875CP		18.7/9.4		VG1875CP+943AGA	VG1875CP+943GGA	VG1875CP+943BGA	VG1875CP+943BUA

1. Valve has a characterizing disk.

Accessories and Repair Parts

Linkage	Replacement Description
M9000-551	Ball Valve Linkage Kit with Handle for M9104 Series Actuators
M9000-560	Ball Valve Linkage Kit for M9203 Series Actuators
M9000-561	Thermal Barrier for VA9104 and VA9203 Series Actuators

Technical Specifications

VG1000 Series Sweat End Connection Stainless Steel Trim Ball Valves		
Service ¹	Hot Water, Chilled Water, and 50/50 Glycol Solutions for HVAC Systems	
Fluid Temperature Limits, without M9000-561 Thermal Barrier	-22°F to 212°F (-30°C to 100°C)	
Fluid Temperature Limits, with M9000-561 Thermal Barrier	-22°F to 284°F (-30°C to 100°C)	
Valve Body Pressure Rating	300 psig, PN40	
Maximum Closeoff Pressure	200 psid (1,378 kPa)	
Maximum Recommended Operating Pressure Drop	50 psi (340 kPa)	
Flow Characteristics	Two-Way	Equal Percentage
	Three-Way	Equal Percentage Flow Characteristics on the In-Line Port A (Coil) and Linear Flow Characteristics of the Angle Port B (Bypass)
Rangeability ²	Greater than 500:1	
Minimum Ambient Operating Temperature	With VA9203 Series Spring-Return Actuators	-22°F (-30°C)
	With M9104 Series Non-Spring-Return Actuators	-4°F (-20°C)
Maximum Ambient Operating Temperature (Limited by the Actuator)	With VA9203 Series Spring-Return Actuators	140°F (60°C)
	With VA9104 Series Non-Spring-Return Actuators	140°F (60°C)
Leakage	0.01% of Maximum Flow per ANSI/FCI 70-2, Class 4	
End Connections	Sweat Note: Use a Low Melting Point Solder.	
Materials	Body	Forged Brass
	Ball	300 Series Stainless Steel
	Blowout-proof Stem	300 Series Stainless Steel
	Seats	Graphite-Reinforced PTFE with Ethylene Propylene Diene Monomer (EPDM) O-Ring Backing
	Stem Seals	EPDM Double O-Rings
	Characterizing Disk	Amodel® AS-1145HS Polyphthalamide Resin

1. Proper water treatment is recommended; refer to the VDI 2035 Guideline.

2. Rangeability is defined as the ratio of maximum controllable flow to minimum controllable flow.

VG1000 Series Press End Connection Stainless Steel Trim Ball Valves

Description

VG1000 Series Ball Valves are designed to regulate the flow of hot or chilled water and, for some models, low-pressure steam in response to the demand of a controller in HVAC systems. Available in sizes 1/2 through 1 in. (DN15 through DN25), this family of two- and three-way forged brass valves is factory or field mounted to Johnson Controls® VA9104 Series Non-Spring-Return and VA9203 Series Spring-Return Electric Actuators for on/off, floating, or proportional control. When supplied with an actuator, the actuator is not mounted to the valve to allow access to the end connections.

Refer to the *VG1000 Series Forged Brass Ball Valves Product Bulletin (LIT-977132)* for important product application information.

Features

- Forged Brass Body — provides 300 psig static pressure rating.
- Graphite-Reinforced Polytetrafluoroethylene (PTFE) Seats — include 15% graphite-reinforced ball seals, providing better wear resistance.
- 500:1 Rangeability — provides accurate control under all load conditions.
- Maintenance-Free Design — performs without failure in excess of 200,000 full stroke cycles in iron-oxide contaminated water.
- Press End Connections — designed to work with RIDGID® pressing tools, reducing installation costs.



VG1000 Series Press End Connection Valves

⚠ WARNING

This product can expose you to chemicals including lead, which is known to the State of California to cause cancer, birth defects, or other reproductive harm. For more information, go to www.P65Warnings.ca.gov.

Selection Charts

VG1000 Press End Connection Valves, Stainless Steel Trim, Non-Spring-Return Actuators with M3 Screw Terminal

Valve Code Number	Size, in.	Cv (Control Port) / Cv (Bypass Port)	Closeoff psig	AC 24 V		
				On/Off (Floating) without Timeout ¹	On/Off (Floating) with Timeout	0 to 10 VDC Proportional
				VA9104-AGA-3S ²	VA9104-IGA-3S ²	VA9104-GGA-3S ²
Two-Way						
VG1295AD	1/2	1.2 ³	200	VG1295AD+9T4AGA	VG1295AD+9T4IGA	VG1295AD+9T4GGA
VG1295AE		1.9 ³		VG1295AE+9T4AGA	VG1295AE+9T4IGA	VG1295AE+9T4GGA
VG1295AF		2.9 ³		VG1295AF+9T4AGA	VG1295AF+9T4IGA	VG1295AF+9T4GGA
VG1295AG		4.7 ³		VG1295AG+9T4AGA	VG1295AG+9T4IGA	VG1295AG+9T4GGA
VG1295AL		7.4 ³		VG1295AL+9T4AGA	VG1295AL+9T4IGA	VG1295AL+9T4GGA
VG1295AN		11.7		VG1295AN+9T4AGA	VG1295AN+9T4IGA	VG1295AN+9T4GGA
VG1295BG	3/4	4.7 ³	200	VG1295BG+9T4AGA	VG1295BG+9T4IGA	VG1295BG+9T4GGA
VG1295BL		7.4 ³		VG1295BL+9T4AGA	VG1295BL+9T4IGA	VG1295BL+9T4GGA
VG1295BN		11.7		VG1295BN+9T4AGA	VG1295BN+9T4IGA	VG1295BN+9T4GGA
VG1295CL	1	7.4 ³	200	VG1295CL+9T4AGA	VG1295CL+9T4IGA	VG1295CL+9T4GGA
VG1295CN		11.7 ³		VG1295CN+9T4AGA	VG1295CN+9T4IGA	VG1295CN+9T4GGA
VG1295CP		18.7		VG1295CP+9T4AGA	VG1295CP+9T4IGA	VG1295CP+9T4GGA
Three-Way						
VG1895AD	1/2	1.2 ³	200	VG1895AD+9T4AGA	VG1895AD+9T4IGA	VG1895AD+9T4GGA
VG1895AE		1.9 ³		VG1895AE+9T4AGA	VG1895AE+9T4IGA	VG1895AE+9T4GGA
VG1895AF		2.9 ³		VG1895AF+9T4AGA	VG1895AF+9T4IGA	VG1895AF+9T4GGA
VG1895AG		4.7 ³		VG1895AG+9T4AGA	VG1895AG+9T4IGA	VG1895AG+9T4GGA
VG1895AL		7.4 ³		VG1895AL+9T4AGA	VG1895AL+9T4IGA	VG1895AL+9T4GGA
VG1895AN		11.7		VG1895AN+9T4AGA	VG1895AN+9T4IGA	VG1895AN+9T4GGA
VG1895BG	3/4	4.7 ³	200	VG1895BG+9T4AGA	VG1895BG+9T4IGA	VG1895BG+9T4GGA
VG1895BL		7.4 ³		VG1895BL+9T4AGA	VG1895BL+9T4IGA	VG1895BL+9T4GGA
VG1895BN		11.7		VG1895BN+9T4AGA	VG1895BN+9T4IGA	VG1895BN+9T4GGA
VG1895CL	1	7.4 ³	200	VG1895CL+9T4AGA	VG1895CL+9T4IGA	VG1895CL+9T4GGA
VG1895CN		11.7 ³		VG1895CN+9T4AGA	VG1895CN+9T4IGA	VG1895CN+9T4GGA
VG1895CP		18.7		VG1895CP+9T4AGA	VG1895CP+9T4IGA	VG1895CP+9T4GGA

1. To avoid excessive wear or drive time on the motor for the AGx models, use a controller or software that provides a timeout function to remove the signal at the end of rotation (stall).
2. Code numbers shown are for a VA9104-xGA-3S actuator with M3 screw terminals. To specify a 48-in. plenum rated cable, change 9T4 to 9A4 in the code number for a VA9104-xGA-2S actuator. For example, VG1241AD+9T4AGA becomes VG1241AD+9A4AGA.
3. Valve has a characterizing disk.

The performance specifications are nominal and conform to acceptable industry standards. For applications at conditions beyond these specifications, consult the local Johnson Controls office. Johnson Controls shall not be liable for damages resulting from misapplication or misuse of its products. © 2019 Johnson Controls. www.johnsoncontrols.com

VG1000 Series Press End Connection Stainless Steel Trim Ball Valves (Continued)

VG1000 Press End Connection Valves, Stainless Steel Trim, Spring-Return Actuators

Valve Code Number	Size, in.	Cv (Control Port) / Cv (Bypass Port)	Closeoff psig	AC 24 V			AC 120 V
				Floating	0 to 10 VDC Proportional	On/Off	On/Off
				VA9203-AGA-2Z	VA9203-GGA-2Z	VA9203-BGA-2	VA-9203-BUA-2
Two-Way Spring Return Valve Open (Normally Open)							
VG1295AD	1/2	1.2 ¹	200	VG1295AD+923AGA	VG1295AD+923GGA	VG1295AD+923BGA	VG1295AD+923BUA
VG1295AE		1.9 ¹		VG1295AE+923AGA	VG1295AE+923GGA	VG1295AE+923BGA	VG1295AE+923BUA
VG1295AF		2.9 ¹		VG1295AF+923AGA	VG1295AF+923GGA	VG1295AF+923BGA	VG1295AF+923BUA
VG1295AG		4.7 ¹		VG1295AG+923AGA	VG1295AG+923GGA	VG1295AG+923BGA	VG1295AG+923BUA
VG1295AL		7.4 ¹		VG1295AL+923AGA	VG1295AL+923GGA	VG1295AL+923BGA	VG1295AL+923BUA
VG1295AN		11.7		VG1295AN+923AGA	VG1295AN+923GGA	VG1295AN+923BGA	VG1295AN+923BUA
VG1295BG	3/4	4.7 ¹	200	VG1295BG+22TAGA	VG1295BG+923GGA	VG1295BG+923BGA	VG1295BG+923BUA
VG1295BL		7.4 ¹		VG1295BL+923AGA	VG1295BL+923GGA	VG1295BL+923BGA	VG1295BL+923BUA
VG1295BN		11.7		VG1295BN+923AGA	VG1295BN+923GGA	VG1295BN+923BGA	VG1295BN+923BUA
VG1295CL	1	7.4 ¹	200	VG1295CL+923AGA	VG1295CL+923GGA	VG1295CL+923BGA	VG1295CL+923BUA
VG1295CN		11.7 ¹		VG1295CN+923AGA	VG1295CN+923GGA	VG1295CN+923BGA	VG1295CN+923BUA
VG1295CP		18.7		VG1295CP+923AGA	VG1295CP+923GGA	VG1295CP+923BGA	VG1295CP+923BUA
Two-Way Spring Return Valve Closed (Normally Closed)							
VG1295AD	1/2	1.2 ¹	200	VG1295AD+943AGA	VG1295AD+943GGA	VG1295AD+943BGA	VG1295AD+943BUA
VG1295AE		1.9 ¹		VG1295AE+943AGA	VG1295AE+943GGA	VG1295AE+943BGA	VG1295AE+943BUA
VG1295AF		2.9 ¹		VG1295AF+943AGA	VG1295AF+943GGA	VG1295AF+943BGA	VG1295AF+943BUA
VG1295AG		4.7 ¹		VG1295AG+943AGA	VG1295AG+943GGA	VG1295AG+943BGA	VG1295AG+943BUA
VG1295AL		7.4 ¹		VG1295AL+943AGA	VG1295AL+943GGA	VG1295AL+943BGA	VG1295AL+943BUA
VG1295AN		11.7		VG1295AN+943AGA	VG1295AN+943GGA	VG1295AN+943BGA	VG1295AN+943BUA
VG1295BG	3/4	4.7 ¹	200	VG1295BG+943AGA	VG1295BG+943GGA	VG1295BG+943BGA	VG1295BG+943BUA
VG1295BL		7.4 ¹		VG1295BL+943AGA	VG1295BL+943GGA	VG1295BL+943BGA	VG1295BL+943BUA
VG1295BN		11.7		VG1295BN+943AGA	VG1295BN+943GGA	VG1295BN+943BGA	VG1295BN+943BUA
VG1295CL	1	7.4 ¹	200	VG1295CL+943AGA	VG1295CL+943GGA	VG1295CL+943BGA	VG1295CL+943BUA
VG1295CN		11.7 ¹		VG1295CN+943AGA	VG1295CN+943GGA	VG1295CN+943BGA	VG1295CN+943BUA
VG1295CP		18.7		VG1295CP+943AGA	VG1295CP+943GGA	VG1295CP+943BGA	VG1295CP+943BUA

1. Valve has a characterizing disk.

Three-Way Spring-Return Actuators (Part 1 of 2)

Valve Code Number	Size, in.	Cv (Control Port) / Cv (Bypass Port)	Closeoff psig	AC 24 V			AC 85-264V
				Floating	0 to 10 VDC Proportional	On/Off	On/Off
				VA9203-AGA-2Z	VA9203-GGA-2Z	VA9203-BGA-2	VA9203-BUA-2
Three-Way Spring Return Counterclockwise, Port A (Coil) Open							
VG1895AD	1/2	1.2 ¹	200	VG1895AD+923AGA	VG1895AD+923GGA	VG1895AD+923BGA	VG1895AD+923BUA
VG1895AE		1.9 ¹		VG1895AE+923AGA	VG1895AE+923GGA	VG1895AE+923BGA	VG1895AE+923BUA
VG1895AF		2.9 ¹		VG1895AF+923AGA	VG1895AF+923GGA	VG1895AF+923BGA	VG1895AF+923BUA
VG1895AG		4.7 ¹		VG1895AG+923AGA	VG1895AG+923GGA	VG1895AG+923BGA	VG1895AG+923BUA
VG1895AL		7.4 ¹		VG1895AL+923AGA	VG1895AL+923GGA	VG1895AL+923BGA	VG1895AL+923BUA
VG1895AN		11.7		VG1895AN+923AGA	VG1895AN+923GGA	VG1895AN+923BGA	VG1895AN+923BUA
VG1895BG	3/4	4.7 ¹	200	VG1895BG+923AGA	VG1895BG+923GGA	VG1895BG+923BGA	VG1895BG+923BUA
VG1895BL		7.4 ¹		VG1895BL+923AGA	VG1895BL+923GGA	VG1895BL+923BGA	VG1895BL+923BUA
VG1895BN		11.7		VG1895BN+923AGA	VG1895BN+923GGA	VG1895BN+923BGA	VG1895BN+923BUA
VG1895CL	1	7.4 ¹	200	VG1895CL+923AGA	VG1895CL+923GGA	VG1895CL+923BGA	VG1895CL+923BUA
VG1895CN		11.7 ¹		VG1895CN+923AGA	VG1895CN+923GGA	VG1895CN+923BGA	VG1895CN+923BUA
VG1895CP		18.7		VG1895CP+923AGA	VG1895CP+923GGA	VG1895CP+923BGA	VG1895CP+923BUA



WARNING This product is made of copper alloy, which contains lead. The product is therefore not to be used on drinking water.

VG1000 Series Press End Connection Stainless Steel Trim Ball Valves (Continued)

Three-Way Spring-Return Actuators (Part 2 of 2)

Valve Code Number	Size, in.	Cv (Control Port) / Cv (Bypass Port)	Closeoff psig	AC 24 V			AC 85-264V
				Floating	0 to 10 VDC Proportional	On/Off	On/Off
				VA9203-AGA-2Z	VA9203-GGA-2Z	VA9203-BGA-2	VA9203-BUA-2
Three-Way Spring Return Clockwise, Port B (Bypass) Open							
VG1895AD	1/2	1.2 ¹	200	VG1895AD+943AGA	VG1895AD+943GGA	VG1895AD+943BGA	VG1895AD+943BUA
VG1895AE		1.9 ¹		VG1895AE+943AGA	VG1895AE+943GGA	VG1895AE+943BGA	VG1895AE+943BUA
VG1895AF		2.9 ¹		VG1895AF+943AGA	VG1895AF+943GGA	VG1895AF+943BGA	VG1895AF+943BUA
VG1895AG		4.7 ¹		VG1895AG+943AGA	VG1895AG+943GGA	VG1895AG+943BGA	VG1895AG+943BUA
VG1895AL		7.4 ¹		VG1895AL+943AGA	VG1895AL+943GGA	VG1895AL+943BGA	VG1895AL+943BUA
VG1895AN		11.7		VG1895AN+943AGA	VG1895AN+943GGA	VG1895AN+943BGA	VG1895AN+943BUA
VG1895BG	3/4	4.7 ¹	200	VG1895BG+943AGA	VG1895BG+943GGA	VG1895BG+943BGA	VG1895BG+943BUA
VG1895BL		7.4 ¹		VG1895BL+943AGA	VG1895BL+943GGA	VG1895BL+943BGA	VG1895BL+943BUA
VG1895BN		11.7		VG1895BN+943AGA	VG1895BN+943GGA	VG1895BN+943BGA	VG1895BN+943BUA
VG1895CL	1	7.4 ¹	200	VG1895CL+943AGA	VG1895CL+943GGA	VG1895CL+943BGA	VG1895CL+943BUA
VG1895CN		11.7 ¹		VG1895CN+943AGA	VG1895CN+943GGA	VG1895CN+943BGA	VG1895CN+943BUA
VG1895CP		18.7		VG1895CP+943AGA	VG1895CP+943GGA	VG1895CP+943BGA	VG1895CP+943BUA

1. Valve has a characterizing disk.

Accessories and Repair Parts

Linkage	Replacement Description
M9000-551	Ball Valve Linkage Kit with Handle for M9104 Series Actuators
M9000-560	Ball Valve Linkage Kit for M9203 Series Actuators

Technical Specifications

VG1000 Series Press End Connection Stainless Steel Trim Ball Valves		
Service ¹	Hot Water, Chilled Water, and 50/50 Glycol Solutions for HVAC Systems	
Fluid Temperature Limits	-22°F to 212°F (-30°C to 100°C)	
Valve Body Pressure Rating	300 psig, PN40	
Maximum Closeoff Pressure	200 psid (1,378 kPa)	
Maximum Recommended Operating Pressure Drop	50 psi (340 kPa)	
Flow Characteristics	Two-Way	Equal Percentage
	Three-Way	Equal Percentage Flow Characteristics on the In-Line Port A (Coil) and Linear Flow Characteristics of the Angle Port B (Bypass)
Rangeability ²	Greater than 500:1	
Minimum Ambient Operating Temperature	With VA9203 Series Spring-Return Actuators	-22°F (-30°C)
	With VA9104 Series Non-Spring-Return Actuators	-4°F (-20°C)
Maximum Ambient Operating Temperature	With VA9203 Series Spring-Return Actuators	140°F (60°C)
	With VA9104 Series Non-Spring-Return Actuators	140°F (60°C)
Leakage	0.01% of Maximum Flow per ANSI/FCI 70-2, Class 4	
End Connections	Press (ProPress® Compatible, 1/2 through 1 in. Sizes) Press End Connections are Designed to Work with RIDGID Pressing Tools.	
Materials	Body	Forged Brass
	Ball	300 Series Stainless Steel
	Blowout Proof Stem	300 Series Stainless Steel
	Seats	Graphite-Reinforced PTFE with Ethylene Propylene Diene Monomer (EPDM) O-Ring Backing
	Stem Seals	EPDM Double O-Rings
	Characterizing Disk	Amodel® AS-1145HS Polyphthalamide Resin

1. Proper water treatment is recommended; refer to the VDI 2035 Guideline.

2. Rangeability is defined as the ratio of maximum controllable flow to minimum controllable flow.

WARNING: BRASS MAY CONTAIN LEAD

To fulfill our obligations towards Article 33, in accordance to the European REACH Regulation No 1907/2006 EC, we hereby inform you that this article contains the following Substances of Very High Concern mentioned on the Candidate list:

- Lead

The performance specifications are nominal and conform to acceptable industry standards. For applications at conditions beyond these specifications, consult the local Johnson Controls office. Johnson Controls shall not be liable for damages resulting from misapplication or misuse of its products. © 2019 Johnson Controls. www.johnsoncontrols.com

VA9905 Series Actuators - VG1600 Series 270° Six-Way Ball Valves

Description

The VA9905 Series Electric Non-Spring Return Actuators are direct-mount actuators for VG1600 Series 270° Six-Way Ball Valves.

The easy-to-use mounting system of the VA9905 Series Electric Non-Spring Return Actuator and VG1600 Series 270° Six-Way Ball Valve reduces mistakes in the installation due to its intuitive assembly mechanism. The actuator is guided by plastic posts and tabs that align with the valve flange and stem notch for proper installation.

VG1600 Series 270° Six-Way Ball Valves are designed to easily and efficiently regulate the flow of both hot and chilled water in response to the demand of a controller in HVAC systems. It is a multi-input signal 24 V AC/DC actuator with Brushless DC Motor Technology. The actuator can also be configured for thermostat controlled On/Off heating and cooling applications and driven by a 24VAC thermostat or controller.

The 270° Six-Way Valve substitutes either four through valves or two through valves and one change-over valve. The true close-off feature, which is internal to the valve, isolates the Source 1 circuit from the Source 2 circuit.

The VG1600 is supplied with control flow disks providing the right flow rate for a wide range of applications. Available in 1/2 inch and 3/4 inch sizes, the valve is operated by a 270° rotary multi-input signal non-spring return actuator.

Refer to the *VA9905 and VG1600 Product Bulletin (LIT-12012553)* for important product application information.

Features

VA9905 Actuator

- Control Options:
 - 2 Analog Inputs
 - 1 Analog Input
 - 2 24VAC Inputs
- Microprocessor-Controlled Brushless DC Motor
- Mode Configuration Switches
- Simplified installation and field wiring
- Plenum-Rated Models
- Small Footprint
- NEMA5/IP54 Enclosure
- Position Indicator Handle and Manual Override
- Manufactured under ISO-9001 Quality Control Standards
- UL, CE Mark, and RCM Compliance
- 100,000 Cycles and 2.5 Million Repositions
- 5-Year Warranty

VG1600 270° Six-Way Ball Valves

- Available in NPT (internal), BSPP (external) and Sweat Union Fittings
- Forged Brass Body
- Ethylene Propylene Diene Monomer (EPDM) Double O-Ring Stem Seal
- Graphite-Reinforced Polytetrafluoroethylene (PTFE) Seats
- Maintenance – Free Design
- 100,000 full stroke cycles in iron oxide contaminated water
- Various valve configurations with just one valve size
- Available in 1/2 inch and 3/4 inch sizes
- Factory- Mounted VA9905 Series Electric Actuator



VA9905 Actuator and VG1600 6-way Valve

Repair Information

If the VA9905 Series Actuator or VG1600 Series 270° Six-Way Ball Valve fails to operate within its specifications, replace the unit. For a replacement VA9905 Actuator or VG1600 Ball Valve, contact the nearest Johnson Controls® representative.

Selection Chart

Valves and Actuators Ordering Codes

Code Number	Description
VG1641AF	Six-Way Ball Valve with 1/2" NPT internal threads
VG1671AF	Six-Way Ball Valve with 1/2" BSPP external threads + 6x Sweat Union Fitting
VG1641BL	Six-Way Ball Valve with 3/4" NPT internal threads
VG1671BL	Six-Way Ball Valve with 3/4" BSPP external threads + 6x Sweat Union Fitting
VA9905-KGA-2	Multi-Input Signal Actuator 5Nm furnished with 2 x 0(2)... 10V, 1 x 0(2)... 10V Analog Inputs, 2 x 24V Inputs
VG1641AF+905KGA	Multi-Input Signal Actuator 5Nm furnished with 2 x 0(2)... 10V, 1 x 0(2)... 10V Analog Inputs, 2 x 24V Inputs + Six-Way Ball Valve 1/2" NPT internal threads
VG1671AF+905KGA	Multi-Input Signal Actuator 5Nm furnished with 2 x 0(2)... 10V, 1 x 0(2)... 10V Analog Inputs, 2 x 24V Inputs + Six-Way Ball Valve 1/2" BSPP external threads + 6x Sweat Union Fitting
VG1641BL+905KGA	Multi-Input Signal Actuator 5Nm furnished with 2 x 0(2)... 10V, 1 x 0(2)... 10V Analog Inputs, 2 x 24V Inputs + Six-Way Ball Valve 3/4" NPT internal threads
VG1671BL+905KGA	Multi-Input Signal Actuator 5Nm furnished with 2 x 0(2)... 10V, 1 x 0(2)... 10V Analog Inputs, 2 x 24V Inputs + Six-Way Ball Valve 3/4" BSPP external threads + 6x Sweat Union Fitting

Note: Optional 0(4)...20mA control with field furnished 500 ohm 1/4" resistor for proportional control

Accessories Ordering Codes

Code Number	Description
VG1600-01	Mounting Bracket
VG1600-02	1/2" Flow Disk Kit (2 x flow disk sets + 2 x ring nut)
VG1600-03	1/2" Insulation Shell
VG1600-04	1/2" Sweat Union Fitting kits (6x sweat union fitting)
VG1600-05	3/4" Flow Disk Kit (2 x flow disk sets + 2 x ring nut)
VG1600-06	3/4" Insulation Shell
VG1600-07	3/4" Sweat Union Fitting kits (6x sweat union fitting)

The performance specifications are nominal and conform to acceptable industry standards. For applications at conditions beyond these specifications, consult the local Johnson Controls office. Johnson Controls shall not be liable for damages resulting from misapplication or misuse of its products. © 2019 Johnson Controls. www.johnsoncontrols.com

VA9905 Series Actuators - VG1600 Series 270° Six-Way Ball Valves (Continued)

Technical Specifications

VA9905 Actuator

Product description	VA9905-KGA-2 (North America): Multi-Input Signal mode actuator.
Power requirements	AC 24 V \pm 20% at 50/60 Hz, Class 2 (North America) or SELV (Europe), 4.7 VA Running; DC 24 V \pm 10% Class 2 (North America) or SELV (Europe), 1.4 W Running.
Transformer sizing requirements	\geq 6 VA
Input signal/adjustments	0 (2) to 10 VDC or 0 (4) to 20 mA with field furnished 500 ohm 1/4 W resistor for proportional control or 24VAC dual wire on/off control
Control impedance	100k ohm DC, 4.7k ohm AC
Rotation rate	1.5 ° per second
Cycles	100,000 full stroke cycles; 2,500,000 repositions
Audible noise	<35 dBA at 1 m (39-13/32 in.)
Electrical connections	120 in. (3.05 m) UL 444 type CMP plenum rated cable with 0.75 mm ² (19 AWG cable) conductors and 0.25 in. (6 mm) ferrule ends
Conduit connections	1/2 in. NPSM threaded conduit
Ambient conditions	Operating: 32 to 140°F (0 to 60°C), 90% RH, noncondensing, Storage: -40 to 185°F (-40 to 85°C), 95% RH, noncondensing
Enclosure	IP54/NEMA 5
Dimensions	Width: 3-1/2 in. (89 mm), Height: 2-15/16 in. (74 mm), Length: 5-11/16 in. (170mm)
Shipping weight	1.75 lbs (0.8 Kg)
Compliance	<p>United States: UL Listed, CCN XAPX, File E27734; to UL 60730-1: Automatic Electrical Controls for Household and Similar Use, Part 1; and UL 60730-2-14: Part 2, Particular Requirements for Electric Actuators, Plenum Rated (UL 2043). Suitable for use in Other Environmental Air Space (Plenum) in accordance with section 300.22 (c) of the National Electrical Code.</p> <p>Canada: UL Listed, CCN XAPX7, File E27734; to CAN/CSA E60730-1:02: Automatic Electrical Controls for Household and Similar Use, Part 1; and CAN/CSA-E60730-2-14, Particular Requirements for Electric Actuators.</p> <p>Europe: CE Mark—Johnson Controls declares that this product is in compliance with the essential requirements and other relevant provisions of the EMC Directive. IEC 60730-1: Automatic Electrical Controls for Household and Similar Use, Part 1: General Requirements and IEC 60730-2-14, Automatic Electrical Controls for Household and Similar Use; Part 2—Particular Requirements for Electric Actuators</p> <p>Australia and New Zealand: RCM—Australia/NZ Emissions Compliant</p>

VG1600 Six-Way Ball Valve

	VG16x1AF	VG16x1BL
Total operation angle	270°	
Sequence 1	0...>90°	
Dead band	>90...<180°	
Sequence 2	>180...270°	
Characteristic curve	Linear	
ID	10.5 mm	15mm
Fluid type	Water, glycol solutions (max 50%) for HVAC applications	
Fluid temperature	41 to 203 °F (5 to 95 °C)	
Nominal pressure	232 psi (PN16)	
Close off pressure	50 psi (350 kPa)	
Max. differential pressure	35 psi (240 kPa)	
Range ability	100:1	
Max. Cv (Kv)	3.3 (3.8) - 1/2" pipe size	6.3 (7.4) - 3/4" pipe size
Body	Brass CW 617N (UNI EN 12420)	
End Connection	Brass CW 617N (UNI EN 12420)	
Balls	Brass Chrome Plated	
Stems	Brass Chrome Plated	
Ball Seat	PTFE 15% Graphite Filled	
O-ring	EPDM PEROX	
Ring Nut	Brass CW 614N (UNI EN 12164 – UNI EN 12168)	
Connections	1/2 inch BSPP Thread (external), 1/2 inch NPT Thread (internal), or Sweat Union Fitting Kit	3/4 inch BSPP Thread (external), 3/4 inch NPT Thread (internal), or Sweat Union Fitting Kit
Flow coefficient	Flow control disk	
Leakage rate	A, 100,000 cycles in iron-oxide contaminated water and air-bubble-tight (EN 12266-1)	
Water quality	Iron-oxide contaminated water (900ppm)	
Maintenance	Maintenance Free	
Warranty	Minimum 5 years to our customer	
Shipping Weight	VG1641AF: 1.85 lbs (0.8 Kg), VG1671AF: 2.20 lbs (1 Kg)	VG1641BL: 3.69 lbs (1.7 Kg), VG1671BL: 4.13 lbs (1.9 Kg)

The performance specifications are nominal and conform to acceptable industry standards. For applications at conditions beyond these specifications, consult the local Johnson Controls office. Johnson Controls shall not be liable for damages resulting from misapplication or misuse of its products. © 2019 Johnson Controls. www.johnsoncontrols.com

VA9905 Series Actuators - VG1600 Series 270° Six-Way Ball Valves (Continued)

WARNING

This product is made of copper alloy, which contains lead. The product is therefore not to be used on drinking water.

WARNING

This product can expose you to chemicals including lead, which is known to the State of California to cause cancer, birth defects, or other reproductive harm. For more information, go to www.P65Warnings.ca.gov.

WARNING: BRASS MAY CONTAIN LEAD

To fulfill our obligations towards Article 33, in accordance to the European REACH Regulation No 1907/2006 EC, we hereby inform you that this article contains the following Substances of Very High Concern mentioned on the Candidate list:

- Lead

VA9104 Series Electric Non-Spring Return Valve Actuators

Description

The VA9104 Series Actuators are direct-mount, non-spring return electric valve actuators that operate on AC 24 V or 100 to 240 V power. Use these synchronous motors or stepper motors (for line voltage models) driven actuators to provide accurate positioning on Johnson Controls® VG1000 Series DN15, DN20, and DN25 (1/2, 3/4, and 1 in.) ball valves in HVAC applications.

The VA9104 Series Electric Non-Spring Return Actuators provide a running torque of 35 lb-in (4 N-m). The nominal travel time is 60 seconds at 60 Hz for 90° of rotation.

Refer to the *VA9104 Series Electric Non-Spring Return Valve Actuators Product Bulletin (LIT-12011050)* for important product application information.

Features

- 35 dBA Maximum Audible Noise Rating
- Synchronous Drive
- 100,000 Cycle Rating
- Direct Mounting with Single Screw
- Manual Override
- Plenum Cable or Screw Terminal Electrical Connections
- 3/8 in. Flexible Metal Conduit Connector on VA9104-xxA-2S Models
- Available Weather Shield for Field Mounting
- Optional M9000-561 Thermal Barrier
- 5-Year Warranty

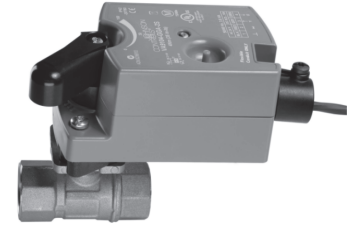

VA9104 Series Electric Non-Spring Return Valve Actuator on a VG1000 Series Ball Valve

Repair Information

If the VA9104 Series Electric Non-Spring Return Valve Actuator fails to operate within its specifications, replace the unit. For a replacement electric actuator, contact the nearest Johnson Controls representative.

Selection Chart

Code Number	Rotation Time For 90°	Power Requirement		Power Consumption		Input Signal			Position Feedback	Electrical Connection			
	Power On – Running (Seconds)	24 VAC + 25%/-20% at 50/60 Hz	85 to 265 V at 50/60 Hz	Amperage: Running	VA Rating, Transformer Sizing	Floating Point Without Timeout	On/Off and Floating Point With Timeout	0 (2) to 10 VDC	0 (4) to 20 mA (with 500 ohm Resistor)	0(2) to 10 VDC	48 in. (1.2 m) UL 444 Type CMP Plenum Rated Cable With 19 AWG (0.75 mm ²) Conductors and 0.25 in. (6 mm) Ferrule Ends and Connector for 3/8 in. (9.5 mm) Flexible Metal Conduit	48 in. (1.2 m) with 18 AWG (1.02mm) conductors and connector for 3/8 in. (9.5 mm) flexible metal conduit	M3 Screw Terminals (Require a Slotted Screwdriver)
VA9104-AGA-2S	60 s at 60 Hz 72 s at 50 Hz	X			2.3	X					X		
VA9104-AGA-3S	60 s at 60 Hz 72 s at 50 Hz	X			2.3	X							X
VA9104-GGA-2S	60 s at 60 Hz 72 s at 50 Hz	X			2.9			X	X		X		
VA9104-GGA-3S	60 s at 60 Hz 72 s at 50 Hz	X			2.9			X					X
VA9104-JGA-2S	60 s at 60 Hz 72 s at 50 Hz	X			3.0		X				X		
VA9104-JGA-3S	60 s at 60 Hz 72 s at 50 Hz	X			3.0		X						X
VA9104-JUA-2S	60 s at 60 Hz 60 s at 50 Hz		X	0.07 A	7.5		X					X	

Accessories

Code Number	Description
M9000-342	Weather Shield Kit for VG1000 Series Ball Application of VA9104, VA9203, VA9208, and VA9308/9310 Series Electric Non-Spring Return Actuators (Quantity 1)
M9000-551	Mounting Hardware Replacement Kit (Quantity 1)
M9000-561	Thermal Barrier Kit for M9000-551 and M9000-560 Ball Valve Linkages. Extends the VA9104, VA9203, VA9208, and VA9308/9310 Series Electric Non-Spring Return Actuators Applications to Include Low-Pressure Steam (Quantity 1)
M9000-700	Universal Ball Valve Linkage (Quantity 1)

The performance specifications are nominal and conform to acceptable industry standards. For applications at conditions beyond these specifications, consult the local Johnson Controls office. Johnson Controls shall not be liable for damages resulting from misapplication or misuse of its products. © 2019 Johnson Controls. www.johnsoncontrols.com

VA9104 Series Electric Non-Spring Return Valve Actuators (Continued)

Technical Specifications

Power Requirements	VA9104-xxx-xS	AC 24 V +25%/-20% at 50/60 Hz, 2.3 VA (-AGA), 2.9 VA (-GGA), 3.0 VA (-IGA) Supply, Class 2 or Safety Extra-Low Voltage (SELV)
	VA9104-IUA-xS	AC 100 to 240 V (-15%/+10%) at 50/60 Hz, 0.07 A Running, and 7.5 VA Supply
Control Type	VA9104-AGA-xS	Floating Control without Timeout
	VA9104-GGA-xS	Proportional Control
	VA9104-IxA-xS	Floating or On/Off Control with Timeout
Control Signal	VA9104-AGA-xS	AC 24 V +25%/-20% at 50/60 Hz, Class 2 or SELV Without Timeout
	VA9104-GGA-xS	DC 0 (2) to 10 V or 0 (4) to 20 mA With Field-Furnished 500 ohm Resistor
	VA9104-IGA-xS	AC 24 V +25%/-20% at 50/60 Hz, Class 2 or SELV With Timeout
	VA9104-IUA-xS	AC 100 to 240V -15%/+10% at 50/60 Hz, and 7.5 VA Supply
Control Input Impedance	VA9104-GGA-xS	Voltage Input: 200,000 ohm Current Input: 500 ohm With Field-Furnished 500 ohm Resistor
Running Torque		35 lb-in (4 N·m)
Travel Time	VA9104-xGA-xS	60 Seconds at 60 Hz (72 Seconds at 50 Hz) for 90° of Rotation
	VA9104-IUA-2S	60 Seconds for 90° of Rotation
Rotation Range		93° ±3°, CW or CCW
Cycles		100,000 Full Stroke Cycles; 2,500,000 Repositions at Rated Running Torque
Audible Noise Rating		35 dBA at 39-13/32 in. (1 m) maximum
Electrical Connections	VA9104-xxA-2S	48 in. (1.2 m) UL 444 Type CMP Plenum Rated cable with 18 AWG (1.02 mm ²) connector for 3/8 in. (9.5 mm) flexible metal conduit.
	VA9104-xGA-3S	M3 Screw Terminals (Requires a Slotted Screwdriver)
	VA9104-IUA-2S	48 in. (1.2 m) with 18 AWG (1.02 mm) conductors and connector for 3/8 in. (9.5 mm) flexible metal conduit.
Enclosure	VA9104-xxA-2S	NEMA 2, IP42
	VA9104-xGA-3S	NEMA 1, IP40
Ambient Conditions	Operating	-4°F to 140°F (-20°C to 60°C); 90% RH Maximum, Noncondensing
	Storage	-40°F to 185°F (-40°C to 85°C); 90% RH Maximum, Noncondensing
Fluid Temperature Limits (Actuator and Valve Assembly)	VG12x1 and VG18x1 Series	23°F to 203°F (-5°C to 95°C)
	VG12x5 and VG18x5 Series	-22°F to 212°F (-30°C to 100°C)
	VG12x5 and VG18x5 Series With M9000-561 Thermal Barrier Installed	-22°F to 284°F (-30°C to 140°C) water; 15 psig (103 kPa) at 250°F (121°C) Saturated Steam
Compliance	United States	UL Listed, CCN XAPX, File 27734 Plenum rated, UL2043, suitable for use in other environmental spaces (plenums) in accordance with section 300.22.(c) of the National Electrical Code
	Canada	cUL Listed, CCN XAPX7, File 27734 Plenum Rated Per CSA 22.2 No. 236/UL 1995, Heating and Cooling Equipment
	Europe	Johnson Controls declares that this product is in compliance with the essential requirements and other relevant provisions of the EMC Directive 2004/108/EC and the Low Voltage Directive 2006/95/EC.
	Australia and New Zealand	C-Tick Mark, Australia/NZ Emissions Compliant
Shipping Weight		1.25 lb (0.55 kg)



This product is made of copper alloy, which contains lead. The product is therefore not to be used on drinking water.



This product can expose you to chemicals including lead, which is known to the State of California to cause cancer, birth defects, or other reproductive harm. For more information, go to www.P65Warnings.ca.gov.

WARNING: BRASS MAY CONTAIN LEAD

To fulfill our obligations towards Article 33, in accordance to the European REACH Regulation No 1907/2006 EC, we hereby inform you that this article contains the following Substances of Very High Concern mentioned on the Candidate list:

- Lead

VA9203-xxx-xx Series Electric Spring-Return Actuators

Description

The VA9203-xxx-xx Series Electric Spring-Return Ball Valve Actuators are direct-mount valve actuators that operate on AC/DC 24 V power. These bidirectional actuators are used to provide accurate positioning on Johnson Controls® VG1000 Series 1/2, 3/4, and 1 in. (DN15, DN20, and DN25) ball valves in HVAC applications. A mechanical spring-return system provides rated torque with or without power applied to the actuator. The series includes the following control options:

- On/Off, 24 V, or 85 to 264 VAC power
- On/Off and Floating Point, 24 V power
- Proportional, 24 V power, for 0(2) to 10 VDC or 0(4) to 20 mA Control Signal

An accessory crankarm and remote mounting kit are available for applications where the actuator cannot be direct-coupled to the damper shaft. An optional line voltage auxiliary switch indicates an end-stop position or performs switching functions within the selected rotation range.

Refer to the *VA9203-xxx-xx Series Electric Spring-Return Actuators Product Bulletin (LIT-12011702)* for important product application information.

Features

- direct mounting with a single screw
- electronic stall detection
- double-insulated construction
- microprocessor-controlled brushless DC motor (-AGx and -GGx types)
- external mode selection switch (-AGx and -GGx types)
- integral cables with colored and numbered conductors
- integral connectors for 1/2 in. (13 mm) threaded conduit connector(s)
- optional integrated auxiliary switch
- plenum rated models
- optional thermal barrier
- available weather shield for field mounting
- override control (Proportional Models only)
- Underwriters Laboratories (UL), CE Mark, and C-Tick Compliance
- manufactured under International Standards Organization (ISO) 9001 Quality Control Standards
- 5-year warranty



VA9203 Series Electric Spring-Return Valve Actuator

Accessories and Replacement Parts

Code Number	Description
M9000-560	Ball Valve Linkage Kit for Applying M9203 and M9208 Series Actuators to VG1000 Series Valves (Quantity 1)
M9000-561	Thermal Barrier Extends M(VA)9104, M(VA)9203, and M(VA)9208 Series Electric Spring-Return Actuator Applications to Include Low-Pressure Steam (Quantity 1)
M9000-342	Weather Shield Kit for VG1000 Series Ball Valve Application of VA9104, VA9203, VA9208, and VA9308/9310 Series Electric Actuators (Quantity 1)
M9000-607	Position Indicator for VG1000 Series Ball Valve Applications (Quantity 5)
M9000-700	Universal Ball Valve Linkage Kit (Quantity 1)

Selection Chart

Code Number	Rotation Time (Seconds) for 90°		Power Requirement		Power Consumption			Input Signal		Position Feedback	Auxiliary Switch	Electrical Connection			
	Power On — Running	Power Off — Spring Return	24 VAC +/- 20% VDC +20%/-10%	85 to 264 VAC +/- 10%	VA Rating, Transformer Sizing	VA: Running (Holding)	Amperage: Running (Holding)	On/Off	On/Off and Floating Point			0(2) to 10 VDC 0(4) to 20 mA (with 500 Ohm Resistor)	0(2) to 10 VDC	SPDT, 5.0 A (2.9 A Inductive) at 240 V	48 in. (1.2 m) 18 AWG Appliance Cable
VA9203-AGA-2Z	90	< 25	■	■	6	5.1 (2.8)	—	■	■						
VA9203-AGB-2Z	90	< 25	■	■	6	5.1 (2.8)	—	■	■		■				
VA9203-BGA-2	< 75	< 75	■	■	6	5.0 (2.5)	—	■	■						
VA9203-BGB-2	< 75	< 75	■	■	6	5.0 (2.5)	—	■	■						
VA9203-BUA-2	< 75	< 75		■	—	—	0.06 (0.02)	■	■						
VA9203-BUB-2	< 75	< 75		■	—	—	0.06 (0.02)	■	■						
VA9203-GGA-2Z	90	< 25	■		6	5.1 (2.8)	—			■	■				
VA9203-GGB-2Z	90	< 25	■		6	5.1 (2.8)	—			■	■				

The performance specifications are nominal and conform to acceptable industry standards. For applications at conditions beyond these specifications, consult the local Johnson Controls office. Johnson Controls shall not be liable for damages resulting from misapplication or misuse of its products. © 2019 Johnson Controls. www.johnsoncontrols.com

VA9203-xxx-xx Series Electric Spring-Return Actuators (Continued)

Technical Specifications

VA9203-GGx-2Z Series Proportional Electric Spring-Return Actuator		
Power Requirements		AC 24 V (AC 19.2 V to 28.8 V) at 50/60 Hz: Class 2 (North America) or Safety Extra-Low Voltage (SELV) (Europe), 4.7 VA Running, 2.7 VA Holding Position DC 24 V (DC 21.6 V to 28.8 V): Class 2 (North America) or SELV (Europe) 1.8 W Running, 1 W Holding Position Minimum Transformer Size: 6 VA per Actuator
Input Signal/Adjustments		Factory Set at DC 0 to 10 V, CW Rotation with Signal Increase Selectable DC 0 (2) to 10 V or 0 (4) to 20 mA with Field Furnished 500 Ohm, 0.25 W Minimum Resistor Switch Selectable Direct or Reverse Action with Signal Increase
Control Input Impedance		Voltage Input: 100,000 Ohms Current Input: 500 Ohms with Field Furnished 500 Ohm Resistor
Feedback Signal		DC 0 (2) to 10 V for Desired Rotation Range up to 95° Corresponds to Rotation Limits, 0.5 mA at 10 V Maximum
Auxiliary Switch Rating	-xxB Models	One Single-Pole, Double-Throw (SPDT), Double-Insulated Switch with Silver Contacts: AC 24 V, 50 VA Pilot Duty AC 120 V, 5.8 A Resistive, 1/4 hp, 275 VA Pilot Duty AC 240 V, 5.0 A Resistive, 1/4 hp, 275 VA Pilot Duty
Spring Return		Direction is Selectable with Mounting Position of Actuator: Actuator Face Labeled A is away from Valve: CCW Spring Return Actuator Face Labeled B is away from Valve: CW Spring Return
Rated Torque	Power On (Running)	27 lb-in (3 N-m) All Operating Temperatures
	Power Off (Spring Returning)	27 lb-in (3 N-m) All Operating Temperatures
Rotation Range		Maximum Full Stroke: 95° Adjustable Stop: 35° to 95° Maximum Position
Rotation Time for 90 Degrees of Travel	Power On (Running)	90 Seconds Constant for 0 lb-in to 27 lb-in (3 N-m) Load, at All Operating Conditions
	Power Off (Spring Returning)	12 to 17 Seconds for 0 lb-in to 27 lb-in (3 N-m) Load, at Room Temperature 16 Seconds Nominal at Full Rated Load 22 Seconds Maximum with 27 lb-in (3 N-m) Load, at -22°F (-30°C)
Life Cycles		60,000 Full Stroke Cycles with 27 lb-in (3 N-m) Load 1,500,000 Repositions with 27 lb-in (3 N-m) Load
Audible Noise Rating	Power On (Running)	< 37 dBA at 27 lb-in (3 N-m) Load, at a Distance of 39-13/32 in. (1 m)
	Power On (Holding)	< 20 dBA at a Distance of 39-13/32 in. (1 m)
	Power Off (Spring Returning)	< 56 dBA at 27 lb-in (3 N-m) Load, at a Distance of 39-13/32 in. (1 m)
Electrical Connections	-GGA-2Z Models	120 in. (3.05 m) UL 444 Type CMP Plenum Rated Cable with 19 AWG (0.75 mm ²) Conductors and 1/4 in. (6 mm) Ferrule Ends
	-GGB-2Z Models	48 in. (1.2 m) UL 758 Type AWM Halogen-Free Cable with 18 AWG (0.85 mm ²) Conductors and 1/4 in. (6 mm) Ferrule Ends
Conduit Connections		Integral 1/2 in. (13 mm) Threaded Conduit Connector(s)
Fluid Temperature Limits	VG12x1 and VG18x1 Series	23°F to 203°F (-5°C to 95°C), Not Rated for Steam Service
	VG12x5 and VG18x5 Series	-22°F to 212°F (-30°C to 100°C), Not Rated for Steam Service
	VG12x5 and VG18x5 Series with M9000-561 Thermal Barrier Installed	-22°F to 284°F (-30°C to 140°C) Water; 15 psig (103 kPa) at 250°F (121°C) Saturated Steam
Ambient Conditions	Standard Operating	-22°F to 140°F (-30°C to 60°C); 90% RH Maximum, Noncondensing
	Storage	-40°F to 185°F (-40°C to 85°C); 95% RH Maximum, Noncondensing
Enclosure Rating		NEMA 2 (IP54) for All Mounting Directions
Compliance	United States	UL Listed, CCN XAPX, File E27734; to UL 60730-1A: 2003-08, Ed. 3.1, Automatic Electrical Controls for Household and Similar Use; and UL 60730-2-14: 2002-02, Ed. 1, Part 2 Particular Requirements for Electric Actuators
	Canada	UL Listed, CCN XAPX7, File E27734; to UL 60730-1:02-CAN/CSA: July 2002, 3rd Ed., Automatic Electrical Controls for Household and Similar Use; and CSA C22.2 No. 24-93 Temperature Indicating and Regulating Equipment
	Europe	CE Mark – Johnson Controls declares that this product is in compliance with the essential requirements and other relevant provisions of the EMC Directive 2004/108/EC and Low Voltage Directive 2006/95/EC
	Australia and New Zealand	C-Tick Mark, Australia/NZ Emissions Compliant
Shipping Weight	-GGA Models	2.0 lb (0.9 kg)
	-GGB Models	2.4 lb (1.1 kg)

VA9203-xxx-xx Series Electric Spring-Return Actuators (Continued)

VA9203-AGx-2Z Series On/Off and Floating Point Electric Spring-Return Actuators		
Power Requirements		AC 24 V (AC 19.2 V to 28.8 V) at 50/60 Hz: Class 2 (North America) or Safety Extra-Low Voltage (SELV) (Europe), 5.1 VA Running, 2.8 VA Holding Position DC 24 V (DC 21.6 V to 28.8 V): Class 2 (North America) or SELV (Europe) 1.9 W Running, 1.1 W Holding Holding Position Minimum Transformer Size: 6 VA per Actuator
Input Signal/Adjustments		AC 19.2 to 28.8 V at 50/60 Hz or DC 24 V +20%/-10% Class 2 (North America) or SELV (Europe) Minimum Pulse Width: 500 ms
Control Input Impedance		4,700 Ohm Control Inputs
Auxiliary Switch Rating	-xxB Models	One Single-Pole, Double-Throw (SPDT), Double-Insulated Switch with Silver Contacts: AC 24 V, 50 VA Pilot Duty AC 120 V, 5.8 A Resistive, 1/4 hp, 275 VA Pilot Duty AC 240 V, 5.0 A Resistive, 1/4 hp, 275 VA Pilot Duty
Spring Return		Direction is Selectable with Mounting Position of Actuator: Actuator Face Labeled A is away from Valve: CCW Spring Return Actuator Face Labeled B is away from Valve: CW Spring Return
Rated Torque	Power On (Running)	27 lb-in (3 N·m) All Operating Temperatures
	Power Off (Spring Returning)	27 lb-in (3 N·m) All Operating Temperatures
Rotation Range		Maximum Full Stroke: 95°
Rotation Time for 90 Degrees of Travel	Power On (Running)	90 Seconds Constant for 0 lb-in to 27 lb-in (3 N·m) Load, at All Operating Conditions
	Power Off (Spring Returning)	12 to 17 Seconds for 0 lb-in to 27 lb-in (3 N·m) Load, at Room Temperature 16 Seconds Nominal at Full Rated Load 22 Seconds Maximum with 27 lb-in (3 N·m) Load, at -22°F (-30°C)
Life Cycles		60,000 Full Stroke Cycles with 27 lb-in (3 N·m) Load 1,500,000 Repositions with 27 lb-in (3 N·m) Load
Audible Noise Rating	Power On (Running)	< 37 dBA at 27 lb-in (3 N·m) Load, at a Distance of 39-13/32 in. (1 m)
	Power On (Holding)	< 20 dBA at a Distance of 39-13/32 in. (1 m)
	Power Off (Spring Returning)	< 56 dBA at 27 lb-in (3 N·m) Load, at a Distance of 39-13/32 in. (1 m)
Electrical Connections	-AGA-2Z Models	120 in. (3.05 m) UL 444 Type CMP Plenum Rated Cable with 19 AWG (0.75 mm ²) Conductors and 1/4 in. (6 mm) Ferrule Ends
	-AGB-2Z Models	48 in. (1.2 m) UL 758 Type AWM Halogen-Free Cable with 18 AWG (0.85 mm ²) Conductors and 1/4 in. (6 mm) Ferrule Ends
Conduit Connections		Integral 1/2 in. (13 mm) Threaded Conduit Connectors
Fluid Temperature Limits	VG12x1 and VG18x1 Series	23°F to 203°F (-5°C to 95°C), Not Rated for Steam Service
	VG12x5 and VG18x5 Series	-22°F to 212°F (-30°C to 100°C), Not Rated for Steam Service
	VG12x5 and VG18x5 Series with M9000-561 Thermal Barrier Installed	-22°F to 284°F (-30°C to 140°C) Water; 15 psig (103 kPa) at 250°F (121°C) Saturated Steam
Ambient Conditions	Standard Operating	-22°F to 140°F (-30°C to 60°C); 90% RH Maximum, Noncondensing
	Storage	-40°F to 185°F (-40°C to 85°C); 95% RH Maximum, Noncondensing
Enclosure Rating		NEMA 2 (IP54) for All Mounting Directions
Compliance	United States	UL Listed, CCN XAPX, File E27734; to UL 60730-1A: 2003-08, Ed. 3.1, Automatic Electrical Controls for Household and Similar Use; and UL 60730-2-14: 2002-02, Ed. 1, Part 2 Particular Requirements for Electric Actuators
	Canada	UL Listed, CCN XAPX7, File E27734; to UL 60730-1:02-CAN/CSA: July 2002, 3rd Ed., Automatic Electrical Controls for Household and Similar Use; and CSA C22.2 No. 24-93 Temperature Indicating and Regulating Equipment
	Europe	CE Mark – Johnson Controls declares that this product is in compliance with the essential requirements and other relevant provisions of the EMC Directive 2004/108/EC and the Low Voltage Directive 2006/95/EC.
	Australia and New Zealand	C-Tick Mark, Australia/NZ Emissions Compliant
Shipping Weight	-AGA Models	2.0 lb (0.9 kg)
	-AGB Models	2.4 lb (1.1 kg)

The performance specifications are nominal and conform to acceptable industry standards. For applications at conditions beyond these specifications, consult the local Johnson Controls office. Johnson Controls shall not be liable for damages resulting from misapplication or misuse of its products. © 2019 Johnson Controls. www.johnsoncontrols.com

VA9203-xxx-xx Series Electric Spring-Return Actuators (Continued)

VA9203-Bxx-x Series On/Off Electric Spring-Return Actuator		
Power Requirements	-BGx-2 Models	AC 24 V (AC 19.2 V to 28.8 V) at 50/60 Hz: Class 2 (North America) or Safety Extra-Low Voltage (SELV) (Europe), 5 VA Running, 1.6 VA Holding Position DC 24 V (DC 21.6 V to 28.8 V): Class 2 (North America) or SELV (Europe) 2.8 W Running, 0.8 W Holding Position Minimum Transformer Size: 6 VA per Actuator
	-BUx-2 Models	AC 100 V to 240 V (AC 85 V to 264 V) at 50/60 Hz: 0.06 A Running, 0.02 A Holding Position
Auxiliary Switch Rating	-xxB-2 Models	One Single-Pole, Double-Throw (SPDT), Double-Insulated Switch with Silver Contacts: AC 24 V, 50 VA Pilot Duty AC 120 V, 5.8 A Resistive, 1/4 hp, 275 VA Pilot Duty AC 240 V, 5.0 A Resistive, 1/4 hp, 275 VA Pilot Duty
Spring Return		Direction is Selectable with Mounting Position of Actuator: Actuator Face Labeled A is away from Valve: CCW Spring Return Actuator Face Labeled B is away from Valve: CW Spring Return
Rated Torque	Power On (Running)	27 lb-in (3 N·m) All Operating Temperatures
	Power Off (Spring Returning)	27 lb-in (3 N·m) All Operating Temperatures
Rotation Range		Maximum Full Stroke: 95°
Rotation Time for 90 Degrees of Travel	Power On (Running) Bxx-2 Models	53 to 71 Seconds Constant for 0 lb-in to 27 lb-in (3 N·m) Load, at Room Temperature 60 Seconds Nominal at Full Rated Load (0.25 rpm)
	Power Off (Spring Returning)	37 to 46 Seconds for 0 lb-in to 27 lb-in (3 N·m) Load, at Room Temperature 44 Seconds Nominal at Full Rated Load 75 Seconds Maximum with 27 lb-in (3 N·m) Load at -22°F (-30°C)
Life Cycles		60,000 Full Stroke Cycles with 27 lb-in (3 N·m) Load
Audible Noise Rating	Power On (Running)	< 36 dBA at 27 lb-in (3 N·m) Load, at a Distance of 39-13/32 in. (1 m)
	Power On (Holding)	< 20 dBA at a Distance of 39-13/32 in. (1 m)
	Power Off (Spring Returning)	< 35 dBA at 27 lb-in (3 N·m) Load, at a Distance of 39-13/32 in. (1 m)
Electrical Connections	Actuator (All Models)	48 in. (1.2 m) UL 758 Type AWM Halogen-Free Cable with 18 AWG (0.85 mm ²) Conductors and 0.25 in. (6 mm) Ferrule Ends
	Auxiliary Switches (-xxB-2 Models)	48 in. (1.2 m) UL 758 Type AWM Halogen-Free Cable with 18 AWG (0.85 mm ²) Conductors and 0.25 in. (6 mm) Ferrule Ends
Conduit Connections		Integral 1/2 in. (13 mm) Threaded Conduit Connectors
Fluid Temperature Limits	VG12x1 and VG18x1 Series	23°F to 203°F (-5°C to 95°C), Not Rated for Steam Service
	VG12x5 and VG18x5 Series	-22°F to 212°F (-30°C to 100°C), Not Rated for Steam Service
	VG12x5 and VG18x5 Series with M9000-561 Thermal Barrier Installed	-22°F to 284°F (-30°C to 140°C) Water; 15 psig (103 kPa) at 250°F (121°C) Saturated Steam
Ambient Conditions	Standard Operating	-22°F to 140°F (-30°C to 60°C); 90% RH Maximum, Noncondensing
	Storage	-40°F to 185°F (-40°C to 85°C); 95% RH Maximum, Noncondensing
Enclosure Rating		NEMA 2 (IP54) for All Mounting Directions
Compliance	United States	UL Listed, CCN XAPX, File E27734; to UL 60730-1A: 2003-08, Ed. 3.1, Automatic Electrical Controls for Household and Similar Use; and UL 60730-2-14: 2002-02, Ed. 1, Part 2 Particular Requirements for Electric Actuators
	Canada	UL Listed, CCN XAPX7, File E27734; to UL 60730-1:02-CAN/CSA: July 2002, 3rd Ed., Automatic Electrical Controls for Household and Similar Use; and CSA C22.2 No. 24-93 Temperature Indicating and Regulating Equipment
	Europe	CE Mark – Johnson Controls declares that this product is in compliance with the essential requirements and other relevant provisions of the EMC Directive 2004/108/EC and the Low Voltage Directive 2006/95/EC.
	Australia and New Zealand	C-Tick Mark, Australia/NZ Emissions Compliant
Shipping Weight	-xxA Models	2.0 lb (0.9 kg)
	-xxB Models	2.4 lb (1.1 kg)

VA9208-xxx-xx Series Electric Spring-Return Actuators

Description

The VA9208-xxx-xx Series Electric Spring-Return Valve Actuators are direct-mount valve actuators. These bidirectional actuators are used to provide accurate positioning on Johnson Controls® VG1000 Series 1-1/4, 1-1/2, and 2 in. (DN32, DN40, and DN50) ball valves in HVAC applications. A mechanical spring-return system provides rated torque with and without power applied to the actuator. The series includes the following control responses:

- On/Off, 24 V, 120 VAC, 230 VAC power
- On/Off and Floating Point, 24 V power
- Proportional, 24 V power, for 0(2) to 10 VDC or 0(4) to 20 mA Control Signal

Optional line voltage auxiliary switches indicate an end-stop position or perform switching functions within the selected rotation range.

Refer to the *VA9208-xxx-x Series Electric Spring-Return Actuators Product Bulletin (LIT-12011622)* for important product application and single point of contact information.

Features

- direct mounting with a single screw
- electronic stall detection
- double-insulated construction
- microprocessor-controlled brushless DC motor (-AGx and -GGx Models)
- external mode selection switch (-AGx and -GGx Models)
- integral cables with colored and numbered conductors
- integral connectors for 3/8 in. (10 mm) Flexible Metal Conduit (FMC)
- optional integrated auxiliary switches
- plenum rated models
- optional thermal barrier
- override control (proportional models only)
- available weather shield for field mounting
- 5-year warranty



VA9208 Series Electric Spring-Return Valve Actuator

Accessories and Replacement Parts

Code Number	Description
M9000-560	Ball Valve Linkage Kit for Applying M9203 and M9208 Series Actuators to VG1000 Series Valves (Quantity 1)
M9000-561	Thermal Barrier Extends M(VA)9104, M(VA)9203, and M(VA)9208 Series Electric Spring-Return Actuator Applications to Include Low-Pressure Steam (Quantity 1)
M9000-341	Weather Shield Kit for VG1000 Series Ball Valve Application of M(VA)9104, M(VA)9203, and M(VA)9208 Series Electric Spring-Return Actuators (Quantity 1)
M9220-604	Replacement Manual Override Cranks with Long Crank Radius: 2.83 in. (72 mm) (Quantity 5)
M9208-605	Replacement Manual Override Cranks with Short Crank Radius: 1.83 in. (46.5 mm) (Quantity 5)

VA9208-xxx-xx Series Electric Spring-Return Actuators (Continued)

Selection Chart

Code Number	Rotation Time (Seconds) for 90°		Power Requirement				Power Consumption		Input Signal			Position Feedback	Auxiliary Switches	Electrical Connection			
	Power On (Running)	Power Off (Spring Return)	24 VAC +/- 25% VDC +20%/-10%	24 VAC +/- 20% VDC +20%/-10%	120 VAC +/- 10%	230 VAC +/- 10%	VA Rating, Transformer Sizing	VA: Running (Holding)	Amperage: Running (Holding)	On/Off	Floating Point	0(2) to 10 VDC 0(4) to 20 mA (with 500 Ohm Resistor)	0(2) to 10 VDC	2 SPDT, 5.0 A (2.9 A Inductive) at 240 V	48 in. (1.2 m) 18 AWG Appliance Cable	120 in. (3.05 m) 19 AWG Plenum Cable	Integral 3/8 in. FMC Connectors
VA9208-AGA-2	150	17 to 25 ¹	■				8	7.9 (5.5)		■	■				■	■	
VA9208-AGA-3	150	17 to 25 ¹	■				8	7.9 (5.5)		■	■				■		■
VA9208-AGC-3	150	17 to 25 ¹	■				8	7.9 (5.5)		■	■			■	■		■
VA9208-BGA-3	55 to 71	13 to 26 ²	■				7	6.1 (1.2)		■					■		■
VA9208-BGC-3	55 to 71	13 to 26 ²	■				7	6.1 (1.2)		■					■		■
VA9208-BAA-3	55 to 71	13 to 26 ²			■			0.05 (0.03)	■						■		■
VA9208-BAC-3	55 to 71	13 to 26 ²			■			0.05 (0.03)	■						■		■
VA9208-BDA-3	55 to 71	13 to 26 ²				■		0.04 (0.03)	■						■		■
VA9208-BDC-3	55 to 71	13 to 26 ²				■		0.04 (0.03)	■						■		■
VA9208-GGA-2	150	17 to 25 ¹	■				8	7.9 (5.5)				■	■			■	■
VA9208-GGA-3	150	17 to 25 ¹	■				8	7.9 (5.5)				■	■			■	■
VA9208-GGC-3	150	17 to 25 ¹	■				8	7.9 (5.5)				■	■			■	■

- 22 seconds nominal at room temperature and rated load, 94 seconds maximum at rated load and -40°F (-40°C).
- 21 seconds nominal at room temperature and rated load, 39 seconds maximum at rated load and -4°F (-20°C), 108 seconds maximum at 53 lb-in (6 N-m) and -40°F (-40°C).

VA9208-xxx-xx Series Electric Spring-Return Actuators (Continued)

Technical Specifications

VA9208-GGx-xx Series On/Off and Floating Electric Spring-Return Actuators		
Power Requirements	-GGx Models	AC 24 V (AC 19.2 V to 28.8 V) at 50/60 Hz: Class 2 (North America) or Safety Extra-Low Voltage (SELV) (Europe), 7.9 VA Running, 5.5 VA Holding Position DC 24 V (DC 21.6 V to 28.8 V): Class 2 (North America) or SELV (Europe) 3.5 W Running, 1.9 W Holding Position Minimum Transformer Size: 8 VA per Actuator
Input Signal/Adjustments	-GGx Models	Factory Set at DC 0 to 10 V, CW Rotation with Signal Increase Selectable DC 0 (2) to 10 V or 0 (4) to 20 mA with Field Furnished 500 Ohm, 0.25 W Minimum Resistor; Switch Selectable Direct or Reverse Action with Signal Increase
Control Input Impedance	-GGx Models	Voltage Input: 100,000 Ohms Current Input: 500 Ohms with Field Furnished 500 Ohm Resistor
Feedback Signal	-GGx Models	DC 0 (2) to 10 V for Desired Rotation Range up to 95° Corresponds to Rotation Limits, 0.5 mA at 10 V Maximum
Auxiliary Switch Rating	-xxC Models	Two Single-Pole, Double-Throw (SPDT), Double-Insulated Switches with Gold over Silver Contacts: AC 24 V, 50 VA Pilot Duty AC 120 V, 5.8 A Resistive, 1/4 hp, 275 VA Pilot Duty AC 240 V, 5.0 A Resistive, 1/4 hp, 275 VA Pilot Duty
Spring Return		Direction is Selectable with Mounting Position of Actuator: Actuator Face Labeled A is away from Valve: CCW Spring Return Actuator Face Labeled B is away from Valve: CW Spring Return
Rated Torque	Power On (Running)	70 lb·in (8 N·m) All Operating Temperatures
	Power Off (Spring Returning)	70 lb·in (8 N·m) All Operating Temperatures
Rotation Range		Maximum Full Stroke: 95° Adjustable Stop: 35° to 95° Maximum Position
Rotation Time for 90 Degrees of Travel	Power On (Running)	150 Seconds Constant for 0 lb·in to 70 lb·in (8 N·m) Load, at All Operating Conditions 90 Seconds for 0 lb·in to 70 lb·in (8 N·m) in Calibration Mode or Override Mode
	Power Off (Spring Returning)	17 to 25 Seconds for 0 lb·in to 70 lb·in (8 N·m) Load, at Room Temperature 22 Seconds Nominal at Full Rated Load 94 Seconds Maximum with 70 lb·in (8 N·m) Load, at -40°F (-40°C)
Life Cycles		60,000 Full Stroke Cycles with 70 lb·in (8 N·m) Load 1,500,000 Repositions with 70 lb·in (8 N·m) Load
Audible Noise Rating	Power On (Running)	< 35 dBA at 70 lb·in (8 N·m) Load, at a Distance of 39-13/32 in. (1 m)
	Power On (Holding)	< 20 dBA at a Distance of 39-13/32 in. (1 m)
	Power Off (Spring Returning)	< 52 dBA at 70 lb·in (8 N·m) Load, at a Distance of 39-13/32 in. (1 m)
Electrical Connections	-GGx-3 Models	48 in. (1.2 m) UL 758 Type AWM Halogen-Free Cable with 18 AWG (0.85 mm ²) Conductors and 1/4 in. (6 mm) Ferrule Ends
	-GGx-2 Models	120 in. (3.05 m) UL 444 Type CMP Plenum Rated Cable with 19 AWG (0.75 mm ²) Conductors and 1/4 in. (6 mm) Ferrule Ends
	Auxiliary Switches (-xxC Models)	48 in. (1.2 m) UL 758 Type AWM Halogen-Free Cable with 18 AWG (0.85 mm ²) Conductors and 1/4 in. (6 mm) Ferrule Ends
Conduit Connections		Integral Connectors for 3/8 in. (10 mm) Flexible Metal Conduit
Fluid Temperature Limits	VG12x1 and VG18x1 Series	23°F to 203°F (-5°C to 95°C), Not Rated for Steam Service
	VG12x5 and VG18x5 Series	-22°F to 212°F (-30°C to 100°C), Not Rated for Steam Service
	VG12x5 and VG18x5 Series with M9000-561 Thermal Barrier Installed	-22°F to 284°F (-30°C to 140°C) water; 15 psig (103 kPa) at 250°F (121°C) Saturated Steam
Ambient Conditions	Standard Operating	-40°F to 140°F (-40°C to 60°C); 90% RH Maximum, Noncondensing
	Storage	-40°F to 185°F (-40°C to 85°C); 95% RH Maximum, Noncondensing
Enclosure Rating		NEMA 2 (IP54) for All Mounting Directions
Compliance	United States	UL Listed, CCN XAPX, File E27734; to UL 60730-1A: 2003-08, Ed. 3.1, Automatic Electrical Controls for Household and Similar Use; and UL 60730-2-14: 2002-02, Ed. 1, Part 2 Particular Requirements for Electric Actuators
	Canada	UL Listed, CCN XAPX7, File E27734; to UL 60730-1:02-CAN/CSA: July 2002, 3rd Ed., Automatic Electrical Controls for Household and Similar Use; and CSA C22.2 No. 24-93 Temperature Indicating and Regulating Equipment
	Europe	CE Mark – Johnson Controls declares that this product is in compliance with the essential requirements and other relevant provisions of the EMC Directive and the Low Voltage Directive.
	Australia and New Zealand	RCM Mark, Australia/NZ Emissions Compliant
Shipping Weight	-GGA Models	3.5 lb (1.6 kg)
	-GGC Models	3.9 lb (1.8 kg)

The performance specifications are nominal and conform to acceptable industry standards. For applications at conditions beyond these specifications, consult the local Johnson Controls office. Johnson Controls shall not be liable for damages resulting from misapplication or misuse of its products. © 2019 Johnson Controls. www.johnsoncontrols.com

VA9208-xxx-xx Series Electric Spring-Return Actuators (Continued)

VA9208-AGx-x Series On/Off and Floating Point Electric Spring-Return Actuators		
Power Requirements	-AGx Models	AC 24 V (AC 19.2 V to 28.8 V) at 50/60 Hz: Class 2 (North America) or Safety Extra-Low Voltage (SELV) (Europe), 7.9 VA Running, 5.5 VA Holding Position DC 24 V (DC 21.6 V to 28.8 V): Class 2 (North America) or SELV (Europe) 3.5 W Running, 1.9 W Holding Position Minimum Transformer Size: 8 VA per Actuator
Input Signal/Adjustments	-AGx Models	AC 19.2 to 28.8 V at 50/60 Hz or DC 24 V +20%/-10% Class 2 (North America) or SELV (Europe) Minimum Pulse Width: 500 ms
Control Input Impedance	-AGx Models	3,000 Ohm Control Inputs
Auxiliary Switch Rating	-xxC Models	Two Single-Pole, Double-Throw (SPDT), Double-Insulated Switches with Gold over Silver Contacts: AC 24 V, 50 VA Pilot Duty AC 120 V, 5.8 A Resistive, 1/4 hp, 275 VA Pilot Duty AC 240 V, 5.0 A Resistive, 1/4 hp, 275 VA Pilot Duty
Spring Return		Direction is Selectable with Mounting Position of Actuator: Actuator Face Labeled A is away from Valve: CCW Spring Return Actuator Face Labeled B is away from Valve: CW Spring Return
Rated Torque	Power On (Running)	70 lb-in (8 N·m) All Operating Temperatures
	Power Off (Spring Returning)	70 lb-in (8 N·m) All Operating Temperatures
Rotation Range		Maximum Full Stroke: 95°
Rotation Time for 90 Degrees of Travel	Power On (Running)	150 Seconds for 0 lb-in to 70 lb-in (8 N·m) Load, at All Operating Conditions
	Power Off (Spring Returning)	17 to 25 Seconds for 0 lb-in to 70 lb-in (8 N·m) Load, at Room Temperature 22 Seconds Nominal at Full Rated Load 94 Seconds Maximum with 70 lb-in (8 N·m) Load, at -40°F (-40°C)
Life Cycles		60,000 Full Stroke Cycles with 70 lb-in (8 N·m) Load 1,500,000 Repositions with 70 lb-in (8 N·m) Load
Audible Noise Rating	Power On (Running)	< 35 dBA at 70 lb-in (8 N·m) Load, at a Distance of 39-13/32 in. (1 m)
	Power On (Holding)	< 20 dBA at a Distance of 39-13/32 in. (1 m)
	Power Off (Spring Returning)	< 52 dBA at 70 lb-in (8 N·m) Load, at a Distance of 39-13/32 in. (1 m)
Electrical Connections	-AGx-3 Models	48 in. (1.2 m) UL 758 Type AWM Halogen-Free Cable with 18 AWG (0.85 mm ²) Conductors and 1/4 in. (6 mm) Ferrule Ends
	-AGx-2 Models	120 in. (3.05 m) UL 444 Type CMP Plenum Rated Cable with 19 AWG (0.75 mm ²) Conductors and 1/4 in. (6 mm) Ferrule Ends
	Auxiliary Switches (-xxC Models)	48 in. (1.2 m) UL 758 Type AWM Halogen-Free Cable with 18 AWG (0.85 mm ²) Conductors and 1/4 in. (6 mm) Ferrule Ends
Conduit Connections		Integral Connectors for 3/8 in. (10 mm) Flexible Metal Conduit
Fluid Temperature Limits	VG12x1 and VG18x1 Series	23°F to 203°F (-5°C to 95°C), Not Rated for Steam Service
	VG12x5 and VG18x5 Series	-22°F to 212°F (-30°C to 100°C), Not Rated for Steam Service
	VG12x5 and VG18x5 Series with M9000-561 Thermal Barrier Installed	-22°F to 284°F (-30°C to 140°C) Water; 15 psig (103 kPa) at 250°F (121°C) Saturated Steam
Ambient Conditions	Standard Operating	-40°F to 140°F (-40°C to 60°C); 90% RH Maximum, Noncondensing
	Storage	-40°F to 185°F (-40°C to 85°C); 95% RH Maximum, Noncondensing
Enclosure Rating		NEMA 2 (IP54) for All Mounting Directions
Compliance	United States	UL Listed, CCN XAPX, File E27734; to UL 60730-1A: 2003-08, Ed. 3.1, Automatic Electrical Controls for Household and Similar Use; and UL 60730-2-14: 2002-02, Ed. 1, Part 2 Particular Requirements for Electric Actuators
	Canada	UL Listed, CCN XAPX7, File E27734; to UL 60730-1:02-CAN/CSA: July 2002, 3rd Ed., Automatic Electrical Controls for Household and Similar Use; and CSA C22.2 No. 24-93 Temperature Indicating and Regulating Equipment
	Europe	CE Mark – Johnson Controls declares that this product is in compliance with the essential requirements and other relevant provisions of the EMC Directive and the Low Voltage Directive.
	Australia and New Zealand	RCM Mark, Australia/NZ Emissions Compliant
Shipping Weight	-AGA Models	3.5 lb (1.6 kg)
	-AGC Models	3.9 lb (1.8 kg)



VA9208-xxx-xx Series Electric Spring-Return Actuators (Continued)

VA9208-Bxx-x Series On/Off Electric Spring-Return Actuator		
Power Requirements	-BGx Models	AC 24 V (AC 18 V to 30 V) at 50/60 Hz: Class 2 (North America) or Safety Extra-Low Voltage (SELV) (Europe), 6.1 VA Running, 1.2 VA Holding Position DC 24 V (DC 21.6 V to 28.8 V): Class 2 (North America) or SELV (Europe) 3.5 W Running, 0.5 W Holding Position Minimum Transformer Size: 7 VA per Actuator
	-BAx Models	AC 120 V (AC 102 V to 132 V) at 60 Hz: 0.05 A Running, 0.03 A Holding Position
	-BDx Models	AC 230 V (AC 198 V to 264 V) at 50/60 Hz: 0.04 A Running, 0.03 A Holding Position
Auxiliary Switch Rating	-xxC Models	Two Single-Pole, Double-Throw (SPDT), Double-Insulated Switches with Gold over Silver Contacts: AC 24 V, 50 VA Pilot Duty AC 120 V, 5.8 A Resistive, 1/4 hp, 275 VA Pilot Duty AC 240 V, 5.0 A Resistive, 1/4 hp, 275 VA Pilot Duty
Spring Return		Direction is Selectable with Mounting Position of Actuator: Actuator Face Labeled A is away from Valve: CCW Spring Return Actuator Face Labeled B is away from Valve: CW Spring Return
Rated Torque	Power On (Running)	70 lb-in (8 N·m) All Operating Temperatures
	Power Off (Spring Returning)	70 lb-in (8 N·m) at Standard Operating Temperatures 53 lb-in (6 N·m) at Extended Operating Temperatures
Rotation Range		Maximum Full Stroke: 95°
Rotation Time for 90 Degrees of Travel	Power On (Running)	55 to 71 Seconds for 0 lb-in to 70 lb-in (8 N·m) Load, at All Operating Conditions 60 Seconds Nominal at Full Rated Load (0.25 rpm)
	Power Off (Spring Returning)	13 to 26 Seconds for 0 lb-in to 70 lb-in (8 N·m) Load, at Room Temperature 21 Seconds Nominal at Full Rated Load 39 Seconds Maximum with 70 lb-in (8 N·m) Load, at -4°F (-20°C) 108 Seconds Maximum with 53 lb-in (6 N·m) Load at -40°F (-40°C)
Life Cycles		60,000 Full Stroke Cycles with 70 lb-in (8 N·m) Load
Audible Noise Rating	Power On (Running)	< 47 dBA at 70 lb-in (8 N·m) Load, at a Distance of 39-13/32 in. (1 m)
	Power On (Holding)	< 20 dBA at a Distance of 39-13/32 in. (1 m)
	Power Off (Spring Returning)	< 52 dBA at 70 lb-in (8 N·m) Load, at a Distance of 39-13/32 in. (1 m)
Electrical Connections	-Bxx-3 Models	48 in. (1.2 m) UL 758 Type AWM Halogen-Free Cable with 18 AWG (0.85 mm ²) Conductors and 1/4 in. (6 mm) Ferrule Ends
	Auxiliary Switches (-xxC Models)	48 in. (1.2 m) UL 758 Type AWM Halogen-Free Cable with 18 AWG (0.85 mm ²) Conductors and 1/4 in. (6 mm) Ferrule Ends
Conduit Connections		Integral Connectors for 3/8 in. (10 mm) Flexible Metal Conduit
Fluid Temperature Limits	VG12x1 and VG18x1 Series	23°F to 203°F (-5°C to 95°C), Not Rated for Steam Service
	VG12x5 and VG18x5 Series	-22°F to 212°F (-30°C to 100°C), Not Rated for Steam Service
	VG12x5 and VG18x5 Series with M9000-561 Thermal Barrier Installed	-22°F to 284°F (-30°C to 140°C) Water; 15 psig (103 kPa) at 250°F (121°C) Saturated Steam
Ambient Conditions	Standard Operating	-4°F to 140°F (-20°C to 60°C); 90% RH Maximum, Noncondensing
	Extended Operating	-40°F to 4°F (-40°C to -20°C); 90% RH Maximum, Noncondensing
	Storage	-40°F to 185°F (-40°C to 85°C); 95% RH Maximum, Noncondensing
Enclosure Rating		NEMA 2 (IP54) for All Mounting Directions
Compliance	United States	UL Listed, CCN XAPX, File E27734; to UL 60730-1A: 2003-08, Ed. 3.1, Automatic Electrical Controls for Household and Similar Use; and UL 60730-2-14: 2002-02, Ed. 1, Part 2 Particular Requirements for Electric Actuators
	Canada	UL Listed, CCN XAPX7, File E27734; to UL 60730-1:02-CAN/CSA: July 2002, 3rd Ed., Automatic Electrical Controls for Household and Similar Use; and CSA C22.2 No. 24-93 Temperature Indicating and Regulating Equipment
	Europe	CE Mark – Johnson Controls declares that this product is in compliance with the essential requirements and other relevant provisions of the EMC Directive and the Low Voltage Directive.
	Australia and New Zealand	RCM Mark, Australia/NZ Emissions Compliant
Shipping Weight	-BGC Models	3.8 lb (1.7 kg)
	-BAC and -BDC Models	4.2 lb (1.9 kg)
	-BGA Models	3.4 lb (1.5 kg)
	-BAA and -BDA Models	3.8 lb (1.7 kg)

The performance specifications are nominal and conform to acceptable industry standards. For applications at conditions beyond these specifications, consult the local Johnson Controls office. Johnson Controls shall not be liable for damages resulting from misapplication or misuse of its products. © 2019 Johnson Controls. www.johnsoncontrols.com

VA9300 Series Electric Non-Spring Return Valve Actuators

Description

The VA9300 Series Electric Non-Spring Return Actuators are direct mount actuators for valves with ISO Flange mounting such as the VG1000 Series Valves.

The series provides Automatic Signal Input Detection which allows automatic recognition of input signals for on/off, floating, and proportional control.

An optional line voltage auxiliary switch kit can be field installed to indicate an end-stop position or perform switching functions within the selected rotation range. The VA9300 Actuators also feature a NEMA 4X weathershield for applications in harsh environments.

Refer to the *VA9300 Series Electric Non-Spring Return Actuators Product Bulletin (LIT-12012265)* for important product application information.

Features

- automatic signal input detection, on/off, floating, and proportional control with adjustable span and offset
- line voltage on/off and floating models
- high speed on/off and floating models
- easy conversion to valve operation—same actuator used for dampers or valves

- optional accessory kit
- backward compatible auxiliary switch kits and auxiliary potentiometer
- self-calibrating input signal to adjust stroke
- electronic stall detection
- microprocessor-controlled brushless DC motor
- mode configuration switches
- integral cables with colored and numbered conductors
- optional integral 1/2 in. (13 mm) threaded conduit connectors
- plenum-rated models
- small footprint
- M9106, M9109, and M9108 series actuators replacement
- position indicator handle
- same weathershield as M9203 and M9208 series actuators
- NEMA5/IP54 enclosure
- underwriters laboratories Inc.® (UL), CE Mark, and RCM compliance
- manufactured under international standards organization (ISO) 9001 quality control standards
- 100,000 cycles and 2.5 million repositions
- 5-year warranty

VA9310 Series Electric Non-Spring Return Actuator



Repair Information

If the VA9300 Series Electric Non-Spring Return Valve Actuator fails to operate within its specifications, replace the unit. For a replacement actuator, contact the nearest Johnson Controls® representative.

Selection Chart

Table 1: Selection Chart

Code Number	Torque lb.in. (N·m)	Rotation Time For 90° Running (Seconds)	Power Supply		Input Signal			Position Feedback				Electrical Connection		Auxiliary Switches		
			AC/DC 24 V	AC 85 to 264 V	On/Off	Floating	Proportional DC 0 (2) to 10 V (with Adjustable Span)	DC 0 (2) to 10 V	140 Ω	1 k Ω	2 k Ω	10 k Ω	120 in. (3 m) Plenum Cable	48 in. (1 m) Halogen Free Cable	1 x SPDT, AC 3 (0.5) A, 240 V	2 x SPDT, 3 (0.5) A, AC 240 V
VA9308-AGA-2Z	70 (8)	8	X		X	X			X ¹	X ¹	X ¹	X ¹	X		X ¹	X ²
VA9308-AUA-2Z	70 (8)	8		X	X	X			X ¹	X ¹	X ¹	X ¹		X	X ²	X ²
VA9310-AUA-2	90 (10)	90		X	X	X			X ¹	X ¹	X ¹	X ¹		X	X ²	X ²
VA9310-GUA-2	90 (10)	90		X	X	X	X	X ³	X ¹	X ¹	X ¹	X ¹		X	X ²	X ²
VA9310-HGA-2	90 (10)	90	X		X	X	X	X ²	X ¹	X ¹	X ¹	X ¹	X		X ²	X ²
VA9320-AUA-2	180 (20)	90		X	X	X			X ¹	X ¹	X ¹	X ¹		X	X ²	X ²
VA9320-GUA-2	180 (20)	90		X	X	X	X	X ³	X ¹	X ¹	X ¹	X ¹		X	X ²	X ²
VA9320-HGA-2	180 (20)	90	X		X	X	X	X ²	X ¹	X ¹	X ¹	X ¹	X		X ²	X ²
VA9335-AUA-2	310 (35)	150		X	X	X			X ¹	X ¹	X ¹	X ¹		X	X ²	X ²
VA9335-GUA-2	310 (35)	150		X	X	X	X	X ³	X ¹	X ¹	X ¹	X ¹		X	X ²	X ²
VA9335-HGA-2	310 (35)	150	X		X	X	X	X ³	X ¹	X ¹	X ¹	X ¹		X	X ²	X ²

1. With optional external feedback potentiometer kit (M9300-140, M9300-1K, M9300-2K, or M9000-10K).
 2. With optional external auxiliary switch kit (M9300-1 or M9300-2).
 3. Feedback is available when 0 (2) to 10 V proportional input is used.

VA9300 Series Electric Non-Spring Return Valve Actuators (Continued)

Accessories

Code Number	Description
M9000-342	NEMA 4X, IP66/67 weathershield kit for VG1000 Series Ball application of VA9104, VA9300, VA9203, and VA9208 Series Electric Actuators (quantity 1)
M9000-343	NEMA 4X, IP66/67 weathershield for 2 1/2 in. to 6 in. VG1000 Series Ball Valve application of VA9320 and VA9335 Series Electric Actuators
M9000-561	Thermal barrier kit, extends the VA9104, VA9300, VA9203, and VA9208 Series Electric Actuators applications to include low pressure steam
M9000-700	Universal Ball Valve Linkage Kit
M9300-1	External auxiliary switch kit (one single-pole, double-throw)
M9300-2	External auxiliary switch kit (two single-pole, double-throw)
M9300-100	Threaded conduit adapters for 1/2 in. electrician's fittings (quantity 5)
M9300-140	External auxiliary feedback potentiometer 140k ohm
M9300-1K	External auxiliary feedback potentiometer 1k ohm
M9300-2K	External auxiliary feedback potentiometer 2k ohm
M9310-10K	External auxiliary feedback potentiometer 10k ohm
M9310-600	Coupler kit for transformation from VA9308 to M9308 and from VA9310 to M9310 Series Actuators
M9320-600	Coupler kit for transformation to 9320 Series Actuators

VA9300 Dimensions

VA9300 Series Electric Non-Spring Return Actuator and Valve Dimensions (with Optional M9000-561 Thermal Barrier)

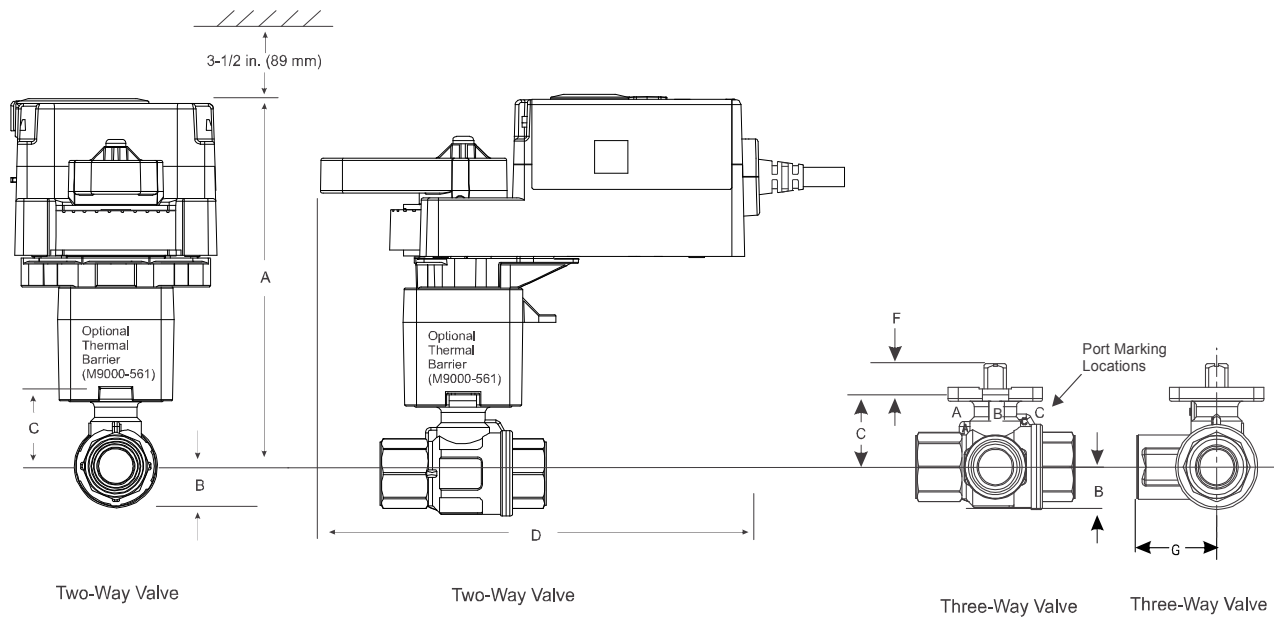

VA9300 Actuated VG1241, VG1245, VG1841, and VG1845 Series Ball Valve Dimensions, in. (mm)

Valve Size, in. (DN)	A (with Thermal Barrier)	A (without Thermal Barrier)	B	C	D	E	F	G
1/2 (DN15)	5-3/4 (146)	4-3/8 (111)	21/32 (17)	1-7/32 (31)	6-13/32 (163)	2-33/64 (64)	11/32 (9)	1-1/4 (32)
3/4 (DN20)	5-3/4 (146)	4-3/8 (111)	21/32 (17)	1-7/32 (31)	6-13/32 (163)	2-51/64 (71)	11/32 (9)	1-13/32 (36)
1 (DN25)	5-13/16 (148)	4-7/16 (113)	3/4 (19)	1-5/16 (33)	6-13/32 (163)	3-13/32 (87)	11/32 (9)	1-45/64 (43)
1-1/4 (DN32)	6-1/4 (159)	4-7/8 (124)	1-1/32 (26)	1-23/32 (44)	6-13/32 (163)	3-15/16 (100)	11/32 (9)	1-31/32 (50)
1-1/2 (DN40)	6-13/32 (163)	5-1/32 (128)	1-1/8 (29)	1-7/8 (48)	6-13/32 (163)	4-21/64 (110)	11/32 (9)	2-11/64 (55)
2 (DN50)	6-5/8 (168)	5-1/4 (133)	1-15/32 (37)	2-1/16 (53)	6-13/32 (163)	4-27/32 (123)	11/32 (9)	2-27/64 (62)

The performance specifications are nominal and conform to acceptable industry standards. For applications at conditions beyond these specifications, consult the local Johnson Controls office. Johnson Controls shall not be liable for damages resulting from misapplication or misuse of its products. © 2019 Johnson Controls. www.johnsoncontrols.com

VA9300 Series Electric Non-Spring Return Valve Actuators (Continued)

VA9300 Series Electric Non-Spring Return Actuator and Valve Dimensions (with Optional M9000-561 Thermal Barrier and M9300-2 Switch Kit)

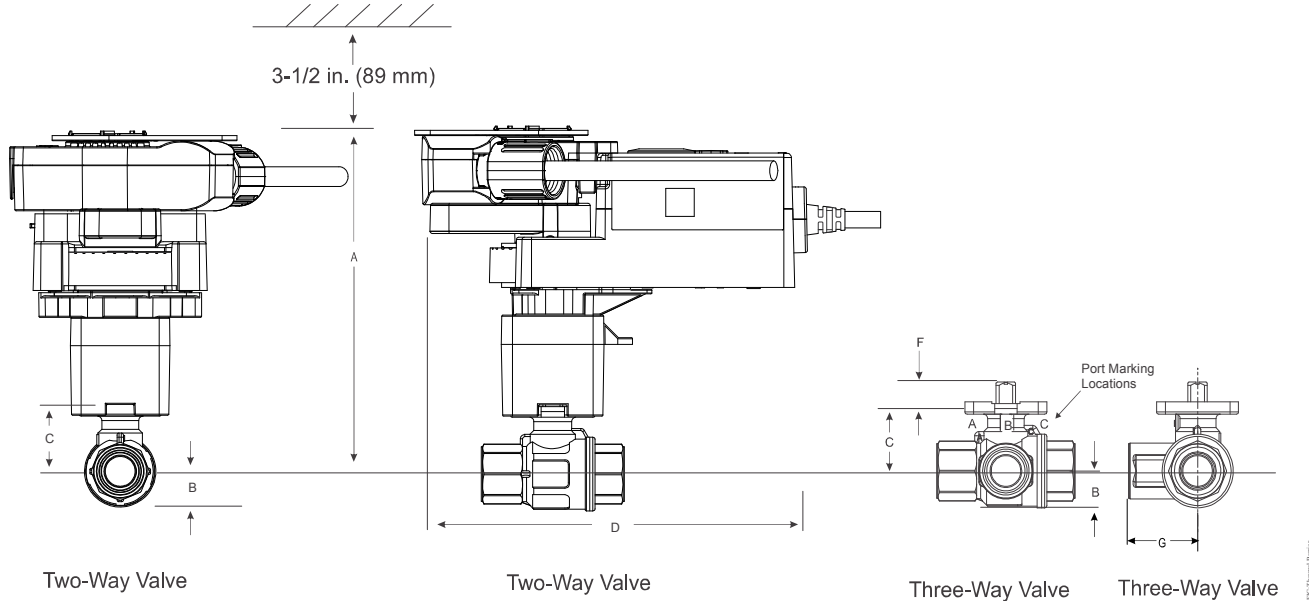

VA9300 Actuated VG1241, VG1245, VG1841, and VG1845 Series Ball Valve Dimensions (with Optional M9000-561 Thermal Barrier and M9300-2 Switch Kit)

Valve Size, in. (DN)	A (with Thermal Barrier)	A (without Thermal Barrier)	B	C	D	E	F	G
1/2 (DN15)	6-3/25 (155.7)	4-3/4 (120.7)	21/32 (17)	1-7/32 (31)	6-21/32 (169)	2-33/64 (64)	11/32 (9)	1-1/4 (32)
3/4 (DN20)	6-3/25 (155.7)	4-3/4 (120.7)	21/32 (17)	1-7/32 (31)	6-21/32 (169)	2-51/64 (71)	11/32 (9)	1-13/32 (36)
1 (DN25)	6-1/5 (157.7)	4-21/25 (122.7)	3/4 (19)	1-5/16 (33)	6-21/32 (169)	3-13/32 (87)	11/32 (9)	1-45/64 (43)
1-1/4 (DN32)	6-16/25 (168.7)	5-1/4 (133.7)	1-1/32 (26)	1-23/32 (44)	6-21/32 (169)	3-15/16 (100)	11/32 (9)	1-31/32 (50)
1-1/2 (DN40)	6-4/5 (172.7)	5-3/7 (137.7)	1-1/8 (29)	1-7/8 (48)	6-21/32 (169)	4-21/64 (110)	11/32 (9)	2-11/64 (55)
2 (DN50)	6 (177.2)	5-5/8 (142.7)	1-15/32 (37)	2-1/16 (53)	6-21/32 (169)	4-27/32 (123)	11/32 (9)	2-27/64 (62)

VA9300 Series Electric Non-Spring Return Valve Actuators (Continued)

Technical Specifications

VA9308-AxA-2Z and VA9310-AUA-2 Series Electric Non-Spring Return Actuators

Product Description	VA9308-AGA-2Z: Floating and on/off mode	VA9308-AUA-2Z: Floating and on/off mode	VA9310-AUA-2: Floating and on/off mode
Power Requirements	AC 24 V \pm 20% at 50/60 Hz, Class 2 (North America) or SELV (Europe), 12.7 VA running. DC 24 V \pm 10% Class 2 (North America) or SELV (Europe), 5.7 W running.	Nominal AC 120 V at 60 Hz: 0.11 A running	Nominal AC 120 V at 60 Hz: 0.04 A running
Transformer Sizing Requirements	\geq 13 VA	—	—
Input Signal/Adjustments	AC 19.2 V to 28.8 V at 50/60 Hz or DC 24 V \pm 10% Class 2 (North America) or SELV (Europe)	AC 100 V to 240 V (AC 85 V to 264 V) at 50/60 Hz	
Rotation Range	Mechanically limited to 95° \pm 3°		
Rotation Time for 90° of Travel	8 seconds, constant at all operating conditions		90 seconds, constant at all operating conditions
Cycles	60,000 full stroke cycles; 1,500,000 repositions		100,000 full stroke cycles; 2,500,000 repositions
Audible Noise	<45 dBA at 0 lb·in to 70 lb·in (8 N·m) load, at a distance of 39-13/32 in. (1m)		<35 dBA at 39-13/32 in. (1m)
Electrical Connections	120 in. (3.05 m) UL 444 type CMP plenum rated cable with 19 AWG (0.75 mm ²) conductors and 0.25 in. (6 mm) ferrule ends	48 in. (1.2 m) halogen free cable with 18 AWG (0.82 mm ²) conductors and 0.25 in. (6mm) ferrule ends	
Conduit Connections	1/2 in. NPSM (13 mm) threaded conduit connectors with M9300-100 Conduit Connector (optional with the VA9308-AGA-2Z)		
Ambient Conditions	Operating: -22°F to 140°F (-30°C to 60°C), 95% RH, noncondensing Storage: -40°F to 185°F (-40°C to 85°C), 95% RH, noncondensing		
Fluid Temperature Limits (Actuator and Valve Assembly)	VG12x1 and VG18x1 Series: 23°F to 203°F (-5°C to 95°C) VG12x5 and VG18x5 Series: -22°F to 212°F (-30°C to 100°C) VG12x5 and VG18x5 Series with M9000-561 Thermal Barrier Installed: -22°F to 284°F (-30°C to 140°C) water; 15 psig (103 kPa) at 250°F (121°C) saturated steam		
Enclosure	IP54/NEMA 5		
Shipping Weight	2 lb (0.9 kg)		
Compliance	<p>United States: UL Listed, CCN XAPX, File E27734; to UL 60730-1: Automatic Electrical Controls for Household and Similar Use, Part 1; and UL 60730-2-14: Part 2, Particular Requirements for Electric Actuators. Plenum Rated (UL 2043). Suitable for use in Other Environmental Air Space (Plenum) in accordance with section 300.22 (c) of the National Electrical Code.</p> <p>Canada: UL Listed, CCN XAPX7, File E27734; to CAN/CSA E60730-1:02: Automatic Electrical Controls for Household and Similar Use, Part 1; and CAN/CSA-E60730-2-14, Particular Requirements for Electric Actuators.</p> <p>Europe: CE Mark—Johnson Controls declares that this product is in compliance with the essential requirements and other relevant provisions of the EMC Directive and the Low Voltage Directive.</p> <p>Australia and New Zealand: RCM Mark, Australia/NZ Emissions Compliant</p>		

The performance specifications are nominal and conform to acceptable industry standards. For applications at conditions beyond these specifications, consult the local Johnson Controls office. Johnson Controls shall not be liable for damages resulting from misapplication or misuse of its products. © 2019 Johnson Controls. www.johnsoncontrols.com

VA9300 Series Electric Non-Spring Return Valve Actuators (Continued)

VA9310-HGA-2 Electric Non-Spring Return Actuators

Product Description	VA9310-HGA-2: On/off and floating mode	VA9310-HGA-2: Proportional mode
Power Requirements	AC 24 V \pm 20% at 50/60 Hz, Class 2 (North America) or SELV (Europe), 4.7 VA running. DC 24 V \pm 10% Class 2 (North America) or SELV (Europe), 1.3 W running.	
Transformer Sizing Requirements	\geq 6.5 VA	
Input Signal/Adjustments	AC 19.2 V to 28.8 V at 50/60 Hz or DC 24 V \pm 10% Class 2 (North America) or SELV (Europe)	DC 0 (2) to 10 V or 0 (4) to 20 mA with field furnished 500 ohm 1/4 W resistor Offset: DC 0 V to 10 V SPAN: DC 2 V to 10 V
Control Impedance	4.7k ohm	100k ohm
Feedback Signal	—	DC 0 (2) to 10 V
Rotation Range	Mechanically limited to 95° \pm 3°	
Rotation Time for 90° of Travel	90 seconds, constant for all operating conditions	
Rotation Time Auto-calibration	35 seconds	
Cycles	100,000 full stroke cycles; 2,500,000 repositions	
Audible Noise	<35 dBA at 0 lb·in to 90 lb·in (10 N·m) load, at a distance of 39-13/32 in. (1 m)	
Electrical Connections	120 in. (3.05 m) UL 444 type CMP plenum rated cable with 19 AWG cable (0.75 mm ²) conductors and 0.25 in. (6 mm) ferrule ends	
Conduit Connections	1/2 in. NPSM (13 mm) threaded conduit connectors with M9300-100 Conduit Connector (optional with the M9310-HGA-2)	
Ambient Conditions	Operating: -22°F to 140°F (-30°C to 60°C), 95% RH, noncondensing Storage: -40°F to 185°F (-40°C to 85°C), 95% RH, noncondensing	
Fluid Temperature Limits (Actuator and Valve Assembly)	VG12x1 and VG18x1 Series: 23°F to 203°F (-5°C to 95°C) VG12x5 and VG18x5 Series: -22°F to 212°F (-30°C to 100°C) VG12x5 and VG18x5 Series with M9000-561 Thermal Barrier Installed: -22°F to 284°F (-30°C to 140°C) water; 15 psig (103 kPa) at 250°F (121°C) saturated steam	
Enclosure	IP54/NEMA 5	
Shipping Weight	2 lb (0.9 kg)	
Compliance	<p>United States: UL Listed, CCN XAPX, File E27734; to UL 60730-1: Automatic Electrical Controls for Household and Similar Use, Part 1; and UL 60730-2-14: Part 2, Particular Requirements for Electric Actuators. Plenum Rated (UL 2043). Suitable for use in Other Environmental Air Space (Plenum) in accordance with section 300.22 (c) of the National Electrical Code.</p> <p>Canada: UL Listed, CCN XAPX7, File E27734; to CAN/CSA E60730-1:02: Automatic Electrical Controls for Household and Similar Use, Part 1; and CAN/CSA-E60730-2-14, Particular Requirements for Electric Actuators.</p> <p>Europe: CE Mark—Johnson Controls declares that this product is in compliance with the essential requirements and other relevant provisions of the EMC Directive and the Low Voltage Directive.</p> <p>Australia and New Zealand: RCM Mark, Australia/NZ Emissions Compliant</p>	



VA9300 Series Electric Non-Spring Return Valve Actuators (Continued)

VA9310-GUA-2 and VA9320-xUA-2 Series Electric Non-Spring Return Actuators

Product Description	VA9310-GUA-2: Proportional mode	VA9320-GUA-2: Floating and on/off mode	VA9320-AUA-2: Floating and on/off mode	VA9335-GUA-2: Proportional mode
Power Requirements	Nominal AC 120 V at 60 Hz: 0.05 A running	Nominal AC 120 V at 60 Hz: 0.05 A running	Nominal AC 120 V at 60 Hz: 0.05 A running	Nominal AC 120 V at 60 Hz: 0.06 A running
Transformer Sizing Requirements	—	—	—	—
Input Signal/ Adjustments	AC 100 V to 240 V (AC 85 V to 264 V) at 50/60 Hz	AC 100 V to 240 V (AC 85 V to 264 V) at 50/60 Hz		
Rotation Range	Mechanically limited to 95° ±3°			
Rotation Time for 90° of Travel	90 seconds, constant at all operating conditions		90 seconds, constant at all operating conditions	150 seconds, constant at all operating conditions
Cycles	60,000 full stroke cycles; 1,500,000 repositions		100,000 full stroke cycles; 2,500,000 repositions	
Audible Noise	<35 dBA at 0 lb·in to 70 lb·in (8 N·m) load, at a distance of 39-13/32 in. (1m)	<45 dBA at 0 lb·in to 70 lb·in (8 N·m) load, at a distance of 39-13/32 in. (1m)	<45 dBA at 39-13/32 in. (1m)	
Electrical Connections	120 in. (3.05 m) UL 444 type CMP plenum rated cable with 19 AWG (0.75 mm ²) conductors and 0.25 in. (6 mm) ferrule ends	48 in. (1.2 m) halogen free cable with 18 AWG (0.82 mm ²) conductors and 0.25 in. (6mm) ferrule ends		
Conduit Connections	1/2 in. NPSM (13 mm) threaded conduit connectors with M9300-100 Conduit Connector (optional with the VA9308-AGA-2Z)			
Ambient Conditions	Operating: -22°F to 140°F (-30°C to 60°C), 95% RH, noncondensing Storage: -40°F to 185°F (-40°C to 85°C), 95% RH, noncondensing			
Fluid Temperature Limits (Actuator and Valve Assembly)	VG12x1 and VG18x1 Series: 23°F to 203°F (-5°C to 95°C) VG12x5 and VG18x5 Series: -22°F to 212°F (-30°C to 100°C) VG12x5 and VG18x5 Series with M9000-561 Thermal Barrier Installed: -22°F to 284°F (-30°C to 140°C) water; 15 psig (103 kPa) at 250°F (121°C) saturated steam			
Enclosure	IP54/NEMA 5			
Shipping Weight	2 lb (0.9 kg)			
Compliance	<p>United States: UL Listed, CCN XAPX, File E27734; to UL 60730-1: Automatic Electrical Controls for Household and Similar Use, Part 1; and UL 60730-2-14: Part 2, Particular Requirements for Electric Actuators. Plenum Rated (UL 2043). Suitable for use in Other Environmental Air Space (Plenum) in accordance with section 300.22 (c) of the National Electrical Code.</p> <p>Canada: UL Listed, CCN XAPX7, File E27734; to CAN/CSA E60730-1:02: Automatic Electrical Controls for Household and Similar Use, Part 1; and CAN/CSA-E60730-2-14, Particular Requirements for Electric Actuators.</p> <p>Europe: CE Mark—Johnson Controls declares that this product is in compliance with the essential requirements and other relevant provisions of the EMC Directive and the Low Voltage Directive.</p> <p>Australia and New Zealand: RCM Mark, Australia/NZ Emissions Compliant</p>			



VA9300 Series Electric Non-Spring Return Valve Actuators (Continued)

VA9320-HGA-2 and VA9335-HGA-2 Electric Non-Spring Return Actuators

Product Description	VA9320-HGA-2 & VA9335-HGA-2	
	On/off and floating mode	Proportional mode
Power Requirements	AC 24 V (AC 19.2 V to 28.8 V) at 50/60 Hz, Class 2 (North America) or SELV (Europe) VA9320-HGA-2: 5.7 VA running; VA9335-HGA-2: 6.1 VA running DC 24 V (DC 21.6 V to 26.4 V) Class 2 (North America) or SELV (Europe) VA9320-HGA-2: 2.1 W running; VA9335-HGA-2: 2.1 W running	
Transformer Sizing Requirements	≥7 VA	
Input Signal/Adjustments	AC 19.2 V to 28.8 V at 50/60 Hz or DC 24 V ±10% Class 2 (North America) or SELV (Europe)	DC 0 (2) to 10 V or 0 (4) to 20 mA with field furnished 500 ohm 1/4 W resistor Offset: DC 0 V to 10 V; SPAN: DC 2 V to 10 V
Control Impedance	4.7k ohm	100k ohm
Feedback Signal	—	DC 0 (2) to 10 V
Running Torque	VA9320-HGA-2: 180 lb·in (20 N·m); VA9335-HGA-2: 310 lb·in (35 N·m)	
Rotation Range	Mechanically limited to 35...95° ±3° in 5° increments	
Rotation Time for 90° of Travel	VA9320-HGA-2: 90 seconds; VA9335-HGA-2: 150 seconds; constant for all operating conditions	
Rotation Time Auto-calibration	VA9320-HGA-2: 35 seconds; VA9335-HGA-2: 75 seconds	
Cycles	VA9320-HGA-2: 100,000 full stroke cycles; 2,500,000 repositions VA9335-HGA-2: 30,000 full stroke cycles; 750,000 repositions	
Audible Noise	<35 dBA at 0 lb·in to 90 lb·in (10 N·m) load, at a distance of 39-13/32 in. (1 m)	
Electrical Connections	120 in. (3.05 m) UL 444 type CMP plenum rated cable with 19 AWG cable (0.75 mm ²) conductors and 0.25 in. (6 mm) ferrule ends	
Conduit Connections	1/2 in. NPSM (13 mm) threaded conduit connectors with M9300-100 Conduit Connector (optional with the M9310-HGA-2)	
Ambient Conditions	Operating: -22°F to 140°F (-30°C to 60°C), 95% RH, noncondensing Storage: -40°F to 185°F (-40°C to 85°C), 95% RH, noncondensing	
Fluid Temperature Limits (Actuator and Valve Assembly)	VG12x1 and VG18x1 Series: 23°F to 203°F (-5°C to 95°C) VG12x5 and VG18x5 Series: -22°F to 212°F (-30°C to 100°C) VG12x5 and VG18x5 Series with M9000-561 Thermal Barrier Installed: -22°F to 284°F (-30°C to 140°C) water; 15 psig (103 kPa) at 250°F (121°C) saturated steam	
Enclosure	IP54/NEMA 5	
Shipping Weight	2 lb (0.9 kg)	
Compliance	<p>United States: UL Listed, CCN XAPX, File E27734; to UL 60730-1: Automatic Electrical Controls for Household and Similar Use, Part 1; and UL 60730-2-14: Part 2, Particular Requirements for Electric Actuators. Plenum Rated (UL 2043). Suitable for use in Other Environmental Air Space (Plenum) in accordance with section 300.22 (c) of the National Electrical Code.</p> <p>Canada: UL Listed, CCN XAPX7, File E27734; to CAN/CSA E60730-1:02: Automatic Electrical Controls for Household and Similar Use, Part 1; and CAN/CSA-E60730-2-14, Particular Requirements for Electric Actuators.</p> <p>Europe: CE Mark—Johnson Controls declares that this product is in compliance with the essential requirements and other relevant provisions of the EMC Directive and the Low Voltage Directive.</p> <p>Australia and New Zealand: RCM Mark, Australia/NZ Emissions Compliant</p>	

The performance specifications are nominal and conform to acceptable industry standard. For application at conditions beyond these specifications, consult the local Johnson Controls office. Johnson Controls shall not be liable for damages resulting from misapplication or misuse of its products.

M9000-700 Universal Ball Valve Linkage Kit

Description

The M9000-700 Universal Ball Valve Linkage Kit is designed specifically for field mounting Johnson Controls® VA(M)9203 and VA(M)9208 Series Spring Return and VA(M)9104 and VA(M)9310 Series Non-Spring Return Actuators to ball valves from various manufacturers in sizes from ½ inch to 2 inches.

These sturdy linkage kits provide easy and stable actuator mounting while preventing loading on the valve stem and stem seals, to ensure longer seal life.

Refer to the *M9000-700 Universal Ball Valve Linkage Kit Product Bulletin (LIT-12012960)* for important product application information.

Features

- Modular design of shaft and actuator allows universal use on ball valves of several manufacturers.
- Sturdy zinc-plated steel shaft and actuator provides exceptional strength and stability which ensures long life even at high torques from 1/2 inch up to two inches.
- Glass-reinforced thermoplastic resin spacer reduces temperature and condensation from the valve to the actuator.
- No special tools required to install which facilitates quick and easy installation.
- Tested for 100,000 full cycles which assures long time reliability on valves from 1/2 inch up to two inches.



M9000-700 Universal Ball Valve Linkage Kit (Continued)

Selection Charts for Johnson Controls Actuators on Ball Valves

Table 1: Belimo B2 and B3 Series Ball Valves

Body Type	Body Size (inches)	Chrome Plated Brass Ball, Nickel Plated Stem	Stainless Steel Ball and Stem	High Temperature Ball Valves	Compatible JCI Actuator See note at foot of table	
Two-way	1/2"	B207B	B207	B215HT029	VA9203 Spring Return VA9208 Spring Return VA9104 Non Spring Return VA9310 Non Spring Return	M9203 Spring Return M9208 Spring Return M9104 Non Spring Return M9310 Non Spring Return
		B208B	B208	B215HT046		
		B209B	B209	B215HT073		
		B210B	B210	B215HT116		
		B211B	B211	B215HT186		
		B212B	B212			
		B213B	B213			
		B214B	B214			
		B215B	B215			
		B216B	B216			
Two-way	3/4"	B217B	B217	B220HT290	VA9208 Spring Return VA9310 Non Spring Return	M9208 Spring Return M9310 Non Spring Return
		B218B	B218	B220HT464		
		B219B	B219	B220HT731		
		B220B	B220	B220HT928		
				B220HT1320		
		B221B	B221			
				B222		
				B223		
				B224		
				B225		
Three-way	1/2"	B307B	B307		VA9203 Spring Return VA9208 Spring Return VA9104 Non Spring Return VA9310 Non Spring Return	M9203 Spring Return M9208 Spring Return M9104 Non Spring Return M9310 Non Spring Return
		B308B	B308			
		B309B	B309			
		B310B	B310			
		B310B	B310			
		B311B	B311			
		B312B	B312			
		B313B	B313			
		B315B	B315			
		Three-way	3/4"	B317B		
B318B	B318					
B320B	B320					
B321B	B321					
				B322		
				B232		
				B325		

Note for VA9208 and M9208 use two field furnished #10-24 x 3 1/2" screws and two locking nuts #10-24

For M9104 use M9000-551 transformation kit and for M9310, use M9310-500 transformation kit

For M9203 and M9208 use M9000-560 transformation kit

M9000-700 Universal Ball Valve Linkage Kit (Continued)

Table 2: Bray Commercial ST Series

Body Size (inches)	Two-way ST Series	Three-way ST Series	Compatible JCI Actuator	
			See note at foot of table	
½"	ST-05-2-004	ST-05-3-003		
	ST-05-2-007	ST-05-3-006		
	ST-05-2-01	ST-05-3-01		
	ST-05-2-003	ST-05-3-02		
	ST-05-2-05	ST-05-3-04		
	ST-05-2-08	ST-05-3-08		
	ST-05-2-12			
¾"	ST-75-2-003	ST-75-3-004		
	ST-75-2-006	ST-75-3-007		
	ST-75-2-01	ST-75-3-01		
	ST-75-2-03	ST-75-3-02		
	ST-75-2-04	ST-75-3-04		
	ST-75-2-10	ST-75-3-13		
	ST-75-2-15			
1"	ST-1-2-004	ST-1-3-004	VA9208 Spring Return VA9310 Non Spring Return	M9208 Spring Return M9310 Non Spring Return
	ST-1-2-009	ST-1-3-007		
	ST-1-2-15	ST-1-3-01		
	ST-1-2-26	ST-1-3-02		
	ST-1-2-44	ST-1-3-04		
	ST-1-2-54	ST-1-3-05		
		ST-1-3-09		
		ST-1-3-10		
		ST-1-3-15		
		ST-1-3-22		
	ST-1-3-31			
1 ¼"	ST-125-2-04	ST-125-3-04		
	ST-125-2-08	ST-125-3-08		
	ST-125-2-15	ST-125-3-09		
	ST-125-2-37	ST-125-3-13		
	ST-125-2-41	ST-125-3-19		
	ST-125-2-102	ST-125-3-34		
1 ½"	ST-150-2-23	ST-150-3-04		
	ST-150-2-41	ST-150-3-08		
	ST-150-2-74	ST-150-3-13		
	ST-150-2-171	ST-150-3-24		
		ST-150-3-32		
2"		ST-150-3-61		
	ST-2-2-41	ST-2-3-24		
	ST-2-2-57	ST-2-3-38		
	ST-2-2-71	ST-2-3-57		
	ST-2-2-100	ST-2-3-109		
	ST-2-2-210			
	ST-2-2-266			

Note for VA9208 and M9208 use two field furnished #10-24 x 3 1/2" screws and two locking nuts #10-24

Also for M9208 use M9000-560 transformation kit

For ST2 Series valves the M9000-700 Universal Ball Valve Linkage kit is not required

M9000-700 Universal Ball Valve Linkage Kit (Continued)

Table 3: Griswold Controls Unimizer Series Valves

Body Type	Body Size (inches)	NPT Threaded, Std Stem & Ball	NPT Threaded, Stainless Steel Stem & Ball	BSPP Threaded, Std Stem & Ball	BSPP Threaded, Stainless Steel Stem & Ball	Lead Free, Std Stem & Ball	Lead Free Stainless Steel Stem & Ball	Compatible JCI Actuator See note at foot of table			
Two-way	1/2"	UR2A1FB	UR2A1FS	UR2A1BB	UR2A1BS	UR2A1LB	UR2A1LS				
		UR2A2FB	UR2A2FS	UR2A2BB	UR2A2BS	UR2A2LB	UR2A2LS				
		UR2A3FB	UR2A3FS	UR2A3BB	UR2A3BS	UR2A3LB	UR2A3LS				
		UR2A4FB	UR2A4FS	UR2A4BB	UR2A4BS	UR2A4LB	UR2A4LS				
		UR2A5FB	UR2A5FS	UR2A5BB	UR2A5BS	UR2A5LB	UR2A5LS				
		UR2A6FB	UR2A6FS	UR2A6BB	UR2A6BS	UR2A6LB	UR2A6LS				
	3/4"	UR2B1FB	UR2B1FS	UR2B1BB	UR2B1BS	UR2B1LB	UR2B1LS				
		UR2B2FB	UR2B2FS	UR2B2BB	UR2B2BS	UR2B2LB	UR2B2LS				
		UR2B3FB	UR2B3FS	UR2B3BB	UR2B3BS	UR2B3LB	UR2B3LS				
		UR2B4FB	UR2B4FS	UR2B4BB	UR2B4BS	UR2B4LB	UR2B4LS				
		UR2B5FB	UR2B5FS	UR2B5BB	UR2B5BS	UR2B5LB	UR2B5LS				
		UR2B6FB	UR2B6FS	UR2B6BB	UR2B6BS	UR2B6LB	UR2B6LS				
	1"	UR2C1FB	UR2C1FS	UR2C1BB	UR2C1BS	UR2C1LB	UR2C1LS			VA9203 Spring Return	M9203 Spring Return
		UR2C2FB	UR2C2FS	UR2C2BB	UR2C2BS	UR2C2LB	UR2C2LS			VA9208 Spring Return	M9208 Spring Return
		UR2C3FB	UR2C3FS	UR2C3BB	UR2C3BS	UR2C3LB	UR2C3LS				
		UR2C4FB	UR2C4FS	UR2C4BB	UR2C4BS	UR2C4LB	UR2C4LS			VA9104 Non-Spring Return	M9104 Non-Spring Return
		UR2C5FB	UR2C5FS	UR2C5BB	UR2C5BS	UR2C5LB	UR2C5LS			VA9310 Non-Spring Return	M9310 Non-Spring Return
		UR2C6FB	UR2C6FS	UR2C6BB	UR2C6BS	UR2C6LB	UR2C6LS				
	1 1/4"	UR2D1FB	UR2D1FS	UR2D1BB	UR2D1BS	UR2D1LB	UR2D1LS				
		UR2D2FB	UR2D2FS	UR2D2BB	UR2D2BS	UR2D2LB	UR2D2LS				
		UR2D3FB	UR2D3FS	UR2D3BB	UR2D3BS	UR2D3LB	UR2D3LS				
		UR2D4FB	UR2D4FS	UR2D4BB	UR2D4BS	UR2D4LB	UR2D4LS				
		UR2D5FB	UR2D5FS	UR2D5BB	UR2D5BS	UR2D5LB	UR2D5LS				
		UR2D6FB	UR2D6FS	UR2D6BB	UR2D6BS	UR2D6LB	UR2D6LS				
	1 1/2"	UR2E1FB	UR2E1FS	UR2E1BB	UR2E1BS	UR2E1LB	UR2E1LS				
		UR2E2FB	UR2E2FS	UR2E2BB	UR2E2BS	UR2E2LB	UR2E2LS				
		UR2E3FB	UR2E3FS	UR2E3BB	UR2E3BS	UR2E3LB	UR2E3LS				
	2"	UR2E4FB	UR2E4FS	UR2E4BB	UR2E4BS	UR2E4LB	UR2E4LS				
		UR2E5FB	UR2E5FS	UR2E5BB	UR2E5BS	UR2E5LB	UR2E5LS				
		UR2E6FB	UR2E6FS	UR2E6BB	UR2E6BS	UR2E6LB	UR2E6LS				
		UR2E7FB	UR2E7FS	UR2E7BB	UR2E7BS	UR2E7LB	UR2E7LS				
		UR2E7FB	UR2E7FS	UR2E7BB	UR2E7BS	UR2E7LB	UR2E7LS				

Note for VA9208 and M9208 use two field furnished #10-24 x 3 1/2" screws and two locking nuts #10-24

For M9104 use M9000-551 transformation kit and for M9310, use M9310-500 transformation kit

For M9203 and M9208 use M9000-560 transformation kit

M9000-700 Universal Ball Valve Linkage Kit (Continued)

Table 4: Griswold Controls Unimizer Series Valves (continued)

Body Type	Body Size (inches)	NPT threaded, Std Stem & Ball	BSPP threaded, Std Stem & Ball	NPT threaded, New	BSP threaded, New	Compatible JCI Actuator See note at foot of table			
Three-way	½"	UR3AAFB	UR3AABB	3WRAAF	3WRAAB				
		UR3ABFB	UR3ABBB	3WRABF	3WRABB				
		UR3ACFB	UR3ACBB	3WRACF	3WRACB				
		UR3ADFB	UR3ADBB	3WRADF	3WRADB				
		UR3AEFB	UR3AEBB	3WRAEF	3WRAEB				
		UR3AFFB	UR3AFBB	3WRAFF	3WRAFB				
	¾"	UR3BAFB	UR3BABB	3WRBAF	3WRBAB				
		UR3BBFB	UR3BBBB	3WRBBF	3WRBBB				
		UR3BCFB	UR3BCBB	3WRBCF	3WRBCB				
		UR3BDFB	UR3BDBB	3WRBDF	3WRBDB				
		UR3BEFB	UR3BEBB	3WRBEF	3WRBEB				
		UR3BFFB	UR3BFBB	3WRBFF	3WRBFB				
	1"	UR3CAFB	UR3CABB					VA9203 Spring Return	M9203 Spring Return
		UR3CBFB	UR3CBBB						
		UR3CCFB	UR3CCBB						
		UR3CDFB	UR3CDBB						
		UR3CEFB	UR3CEBB						
		UR3CFFB	UR3CFBB						
		UR3CGFB	UR3CGBB						
		UR3CHFB	UR3CHBB						
		UR3CJFB	UR3CJBB						
	1 ¼"	UR3DAFB	UR3DABB					VA9208 Spring Return	M9208 Spring Return
		UR3DBFB	UR3DBBB						
		UR3DCF	UR3DCBB						
		UR3DDFB	UR3DDBB						
		UR3DEFB	UR3DEBB						
		UR3DFFB	UR3DFBB						
	1 ½"	UR3EAFB	UR3EABB					VA9104 Non-Spring Return	M9104 Non-Spring Return
		UR3EBFB	UR3EBBB						
		UR3ECFB	UR3ECBB						
		UR3EDFB	UR3EDBB						
		UR3EEFB	UR3EEBB						
	2"	UR3FAFB	UR3FABB					VA9310 Non-Spring Return	M9310 Non-Spring Return
		UR3FBFB	UR3FBBB						
		UR3FCFB	UR3FCBB						
		UR3FDFB	UR3FDDB						
		UR3FEFB	UR3FEBB						

Note for VA9208 and M9208 use two field furnished #10-24 x 3 1/2" screws and two locking nuts #10-24

For M9104 use M9000-551 transformation kit and for M9310, use M9310-500 transformation kit

For M9203 and M9208 use M9000-560 transformation kit

The performance specifications are nominal and conform to acceptable industry standards. For applications at conditions beyond these specifications, consult the local Johnson Controls office. Johnson Controls shall not be liable for damages resulting from misapplication or misuse of its products. © 2019 Johnson Controls. www.johnsoncontrols.com

M9000-700 Universal Ball Valve Linkage Kit (Continued)

Table 5: Honeywell VBN Series Valves

Body Type	Body Size (inches)	Plated Brass Trim, Standard Base	Plated Brass Trim, Low Profile	Plated Brass Trim, MN/MS DCA Actuator Bracket	Stainless Steel Trim, Standard Base	Stainless Steel Trim, Low Profile	Stainless Steel Trim, MN/MS DCA Actuator Bracket	Compatible JCI Actuator See note at foot of table			
Two-way	1/2"	VBN2A000.38PA	VBN2A000.38PL	VBN2A000.38PX	VBN2A000.38SA	VBN2A000.38SL	VBN2A000.38SX				
		VBN2A000.68PA	VBN2A000.68PL	VBN2A000.68PX	VBN2A000.68SA	VBN2A000.68SL	VBN2A000.68SX				
		VBN2A001.30PA	VBN2A001.30PL	VBN2A001.30PX	VBN2A001.30SA	VBN2A001.30SL	VBN2A001.30SX				
		VBN2A002.00PA	VBN2A002.00PL	VBN2A002.00PX	VBN2A002.00SA	VBN2A002.00SL	VBN2A002.00SX				
		VBN2A002.60PA	VBN2A002.60PL	VBN2A002.60PX	VBN2A002.60SA	VBN2A002.60SL	VBN2A002.60SX				
		VBN2A004.70PA	VBN2A004.70PL	VBN2A004.70PX	VBN2A004.70SA	VBN2A004.70SL	VBN2A004.70SX				
		VBN2A008.00PA	VBN2A008.00PL	VBN2A008.00PX	VBN2A008.00SA	VBN2A008.00SL	VBN2A008.00SX				
		VBN2A011.70PA	VBN2A011.70PL	VBN2A011.70PX	VBN2A011.70SA	VBN2A011.70SL	VBN2A011.70SX				
	3/4"	VB2N2000.31PA	VB2N2000.31PL	VB2N2000.31PX	VB2N2000.31SA	VB2N2000.31SL	VB2N2000.31SX			VA9203 Spring Return	M9203 Spring Return
		VB2N2000.63PA	VB2N2000.63PL	VB2N2000.63PX	VB2N2000.63SA	VB2N2000.63SL	VB2N2000.63SX				
		VB2N2001.20PA	VB2N2001.20PL	VB2N2001.20PX	VB2N2001.20SA	VB2N2001.20SL	VB2N2001.20SX				
		VB2N2002.50PA	VB2N2002.50PL	VB2N2002.50PX	VB2N2002.50SA	VB2N2002.50SL	VB2N2002.50SX				
		VB2N2B004.30PA	VB2N2B004.30PL	VB2N2B004.30PX	VB2N2B004.30SA	VB2N2B004.30SL	VB2N2B004.30SX				
		VB2N2B007.40PA	VB2N2B007.40PL	VB2N2B007.40PX	VB2N2B007.40SA	VB2N2B007.40SL	VB2N2B007.40SX				
		VB2N2B010.10PA	VB2N2B010.10PL	VB2N2B010.10PX	VB2N2B010.10SA	VB2N2B010.10SL	VB2N2B010.10SX				
		VB2N2B041.70PA	VB2N2B041.70PL	VB2N2B041.70PX	VB2N2B041.70SA	VB2N2B041.70SL	VB2N2B041.70SX				
	1"	VB2N2C004.40PA	VB2N2C004.40PL	VB2N2C004.40PX	VB2N2C004.40SA	VB2N2C004.40SL	VB2N2C004.40SX			VA9104 Non Spring Return	M9104 Non Spring Return
		VB2N2C009.00PA	VB2N2C009.00PL	VB2N2C009.00PX	VB2N2C009.00SA	VB2N2C009.00SL	VB2N2C009.00SX				
		VB2N2C015.30PA	VB2N2C015.30PL	VB2N2C015.30PX	VB2N2C015.30SA	VB2N2C015.30SL	VB2N2C015.30SX				
		VB2N2C026.00PA	VB2N2C026.00PL	VB2N2C026.00PX	VB2N2C026.00SA	VB2N2C026.00SL	VB2N2C026.00SX				
		VB2N2C044.00PA	VB2N2C044.00PL	VB2N2C044.00PX	VB2N2C044.00SA	VB2N2C044.00SL	VB2N2C044.00SX				
	1 1/4"	VB2N2D004.40PA	VB2N2D004.40PL	VB2N2D004.40PX	VB2N2D004.40SA	VB2N2D004.40SL	VB2N2D004.40SX			VA9310 Non Spring Return	M9310 Non Spring Return
		VB2N2D008.30PA	VB2N2D008.30PL	VB2N2D008.30PX	VB2N2D008.30SA	VB2N2D008.30SL	VB2N2D008.30SX				
		VB2N2D014.90PA	VB2N2D014.90PL	VB2N2D014.90PX	VB2N2D014.90SA	VB2N2D014.90SL	VB2N2D014.90SX				
		VB2N2D025.00PA	VB2N2D025.00PL	VB2N2D025.00PX	VB2N2D025.00SA	VB2N2D025.00SL	VB2N2D025.00SX				
		VB2N2D037.00PA	VB2N2D037.00PL	VB2N2D037.00PX	VB2N2D037.00SA	VB2N2D037.00SL	VB2N2D037.00SX				
	1 1/2"	VB2N2D041.00PA	VB2N2D041.00PL	VB2N2D041.00PX	VB2N2D041.00SA	VB2N2D041.00SL	VB2N2D041.00SX			VA9203 Spring Return	M9203 Spring Return
		VB2N2D102.00PA	VB2N2D102.00PL	VB2N2D102.00PX	VB2N2D102.00SA	VB2N2D102.00SL	VB2N2D102.00SX				
			VB2N2E023.00PX			VB2N2E023.00SX					
			VB2N2E030.00PX			VB2N2E030.00SX					
2"			VB2N2E041.00PX			VB2N2E041.00SX	VA9310 Non Spring Return	M9310 Non Spring Return			
			VB2N2E074.00PX			VB2N2E074.00SX					
			VB2N2E172.00PX			VB2N2E172.00SX					
			VB2N2F042.00PX			VB2N2F042.00SX					
			VB2N2F057.00PX			VB2N2F057.00SX					
			VB2N2F071.00PX			VB2N2F071.00SX					
		VB2N2F100.00PX			VB2N2F100.00SX						
		VB2N2F108.00PX			VB2N2F108.00SX						
		VB2N2F201.00PX			VB2N2F201.00SX						
		VB2N2F266.00PX			VB2N2F266.00SX						

Note for VA9208 and M9208 use two field furnished #10-24 x 3 1/2" screws and two locking nuts #10-24

For M9104 use M9000-551 transformation kit and for M9310, use M9310-500 transformation kit

For M9203 and M9208 use M9000-560 transformation kit

M9000-700 Universal Ball Valve Linkage Kit (Continued)

Table 6: Honeywell VBN Series Valves (continued)

Body Type	Body Size (inches)	Plated Brass Trim, Standard Base	Plated Brass Trim, Low Profile	Plated Brass Trim, MN/MS DCA Actuator Bracket	Compatible JCI Actuator			
					See note at foot of table			
Three-way	1/2"	VBN3A000.33PA	VBN3A000.33PL	VBN3A000.33PX	VA9203 Spring Return	M9203 Spring Return		
		VBN3A000.59PA	VBN3A000.59PL	VBN3A000.59PX				
		VBN3A001.00PA	VBN3A001.00PL	VBN3A001.00PX				
		VBN3A002.40PA	VBN3A002.40PL	VBN3A002.40PX				
		VBN3A004.30PA	VBN3A004.30PL	VBN3A004.30PX				
		VBN3A008.00PA	VBN3A008.00PL	VBN3A008.00PX				
	3/4"	VBN3B000.40PA	VBN3B000.40PL	VBN3B000.40PX				
		VBN3B000.66PA	VBN3B000.66PL	VBN3B000.66PX				
		VBN3B001.30PA	VBN3B001.30PL	VBN3B001.30PX				
		VBN3B002.40PA	VBN3B002.40PL	VBN3B002.40PX				
		VBN3B003.80PA	VBN3B003.80PL	VBN3B003.80PX				
		VBN3B007.00PA	VBN3B007.00PL	VBN3B007.00PX				
	1"	VBN3B011.00PA	VBN3B011.00PL	VBN3B011.00PX				
		VBN3C000.40PA	VBN3C000.40PL	VBN3C000.40PX			VA9208 Spring Return	M9208 Spring Return
		VBN3C000.65PA	VBN3C000.65PL	VBN3C000.65PX			VA9104 Non Spring Return	M9104 Non Spring Return
		VBN3C001.30PA	VBN3C001.30PL	VBN3C001.30PX				
		VBN3C002.30PA	VBN3C002.30PL	VBN3C002.30PX				
		VBN3C003.50PA	VBN3C003.50PL	VBN3C003.50PX			VA9310 Non Spring Return	M9310 Non Spring Return
		VBN3C004.50PA	VBN3C004.50PL	VBN3C004.50PX				
		VBN3C008.60PA	VBN3C008.60PL	VBN3C008.60PX				
	VBN3C014.90PA	VBN3C014.90PL	VBN3C014.90PX					
	1 1/4"	VBN3C022.00PA	VBN3C022.00PL	VBN3C022.00PX				
		VBN3C031.00PA	VBN3C031.00PL	VBN3C031.00PX				
		VBN3D004.10PA	VBN3D004.10PL	VBN3D004.10PX				
		VBN3D008.70PA	VBN3D008.70PL	VBN3D008.70PX				
		VBN3D012.70PA	VBN3D012.70PL	VBN3D012.70PX				
	1 1/2"	VBN3D019.40PA	VBN3D019.40PL	VBN3D019.40PX				
		VBN3D027.00PA	VBN3D027.00PL	VBN3D027.00PX				
VBN3D034.00PA		VBN3D034.00PL	VBN3D034.00PX					
VBN3E0004.00PX			VBN3E0004.00PX	VA9203 Spring Return	M9203 Spring Return			
VBN3E008.30PX		VBN3E008.30PX						
2"	VBN3E013.40PX		VBN3E013.40PX	VA9310 Non Spring Return	M9310 Non Spring Return			
	VBN3E024.00PX		VBN3E024.00PX					
	VBN3E032.00PX		VBN3E032.00PX					
	VBN3E061.00PX		VBN3E061.00PX					
			VBN3F024.00PX					
			VBN3F038.00PX					
			VBN3F057.00PX					
			VBN3F083.00PX					
			VBN3F109.00PX					

Note for VA9208 and M9208 use two field furnished #10-24 x 3 1/2" screws and two locking nuts #10-24

For M9104 use M9000-551 transformation kit and for M9310, use M9310-500 transformation kit

For M9203 and M9208 use M9000-560 transformation kit

M9000-700 Universal Ball Valve Linkage Kit (Continued)

Table 7: Siemens 599 Series Ball Valves

Body Size (inches)	Two-Way OLD Chrome-Plated Ball with Brass Stem	Two-Way Current Chrome-Plated Ball with Brass Stem	Two-Way Stainless Steel Ball and Stem	Three-Way OLD Chrome-Plated Ball with Brass Stem	Three-Way Current Chrome-Plated Ball with Brass Stem	Three-Way Stainless Steel Ball and Stem	Compatible JCI Actuator See note at foot of table	
1/2"	599-10203	599-10300	599-10300S	599-10250	599-10350	599-10350S	VA9208 Spring Return VA9310 Non Spring Return	M9208 Spring Return M9310 Non Spring Return
	599-10204	599-10301	599-10301S	599-10251	599-10351	599-10351S		
	599-10208	599-10302	599-10302S	599-10252	599-10352	599-10352S		
	599-10205	599-10303	599-10303S	599-10253	599-10353	599-10353S		
	599-10206	599-10304	599-10304S	599-10254	599-10354	599-10354S		
	599-10207	599-10305	599-10305S	599-10255	599-10355	599-10355S		
		599-10306	599-10306S		599-10356	599-10356S		
3/4"		599-10307	599-10307S		599-10357	599-10357S		
	599-10209	599-10308	599-10308S	599-10256	599-10358	599-10358S		
	599-10210	599-10309	599-10309S		599-10360	599-10360S		
		599-10310	599-10310S					
1"		599-10311	599-10311S					
	599-10211	599-10312	599-10312S	599-10257	599-10361	599-10361S		
	599-10212	599-10313	599-10313S	599-10258	599-10362	599-10362S		
	599-10213	599-10314	599-10314S	599-10259	599-10363	599-10363S		
1 1/4"	599-10214	599-10315	599-10315S					
		599-10316	599-10316S					
	599-10215	599-10317	599-10317S	599-10260	599-10364	599-10364S		
	599-10216	599-10318	599-10318S	599-10261	599-10365	599-10365S		
	599-10217	599-10319	599-10319S		599-10366	599-10366S		
1 1/2"		599-10320	599-10320S					
		599-10321	599-10321S					
	599-10218	599-10322	599-10322S	599-10262	599-10367	599-10367S		
	599-10219	599-10323	599-10323S	599-10263	599-10368	599-10368S		
	599-10220	599-10324	599-10324S	599-10264	599-10369	599-10369S		
2"	599-10221	599-10325	599-10325S					
		599-10326	599-10326S					
	599-10222	599-10327	599-10327S	599-10265	599-10370	599-10370S		
	599-10223	599-10328	599-10328S	599-10266	599-10371	599-10371S		
	599-10329	599-10329S	599-10267	599-10372	599-10372S			
	599-10224	599-10330	599-10330S					

Note for VA9208 and M9208 use two field furnished #10-24 x 3 1/2" screws and two locking nuts #10-24

For M9208, use M9000-560 transformation kit and for M9310, use M9310-500 transformation kit

M9000-700 Universal Ball Valve Linkage Kit (Continued)

Technical Specifications

Suitable Johnson Controls Actuators	VA9203 Series Spring Return Actuators VA9208 Series Spring Return Actuators VA9104 Series Non Spring Return Actuators VA9310 Series Non Spring Return Actuators
Suitable Valves	See relevant selection charts
Minimum Fluid Temperature Limits	-22°F (-30°C)
Maximum Fluid Temperature Limits	284°F (140°C)
Minimum Ambient Operating Temperature	-4°F (20°C)
Maximum Ambient Operating Temperature	140°F (60°C) 90% RH maximum, non-condensing
Minimum Ambient Storage Temperature	-40°F (-40°C)
Maximum Ambient Storage Temperature	185°F (85°C) 95% RH maximum, non-condensing
Material	Spacer: glass-reinforced thermoplastic resin Shaft: 12L15 steel zinc-plated Connector: 12L15 steel zinc-plated
Shipping Weight	0.4 lbs (0.2kg)

M9000-51x Series Ball Valve Linkage Kits

Description

M9000-51x Series Valve Linkage Kits are designed specifically for field mounting Johnson Controls® M9124 Series Non-Spring Return and M9220 Series Spring Return Electric Actuators to Johnson Controls VG1000 Series Ball Valves in sizes 1 in. through 6 in. (DN25 through DN150). These sturdy linkage kits provide stable actuator mounting while preventing loading on the valve stem and stem seals, to ensure longer seal life.

Refer to the *M9000-51x Series Ball Valve Linkage Kits Product Bulletin (LIT-977354)*, *VG1000 Forged Brass Ball Valves Product Bulletin (LIT-977132)*, or *VG1000 Series Flanged Ball Valves Product Bulletin (LIT-12011228)*, depending on the linkage kit you are using, for important product application and single point of contact information.

Features

- multi-position setup allows the actuator and linkage kit to be positioned in 45-degree increments, facilitating installation in

confined areas

- adjustable anti-rotation slider allows one linkage to accommodate multiple sizes of valve bodies and electric actuators
- index markings on drive shaft and mounting bracket allow the valve to be positioned in increments from fully open to fully closed, providing visual indication of the current valve position during setup and operation
- installation requiring no special tools facilitates quick and easy installation
- thermal spacer between valve and linkage reduces temperature and condensation from the valve to the actuator
- dual-centering bearing design maintains accurate stem alignment eliminating side loading on the VG1000 Series Ball Valve stem and stem seal to ensure longer seal life (M9000-51x Series Ball Valve Linkage Kit only)
- sturdy aluminum construction provides exceptional strength and stability (M9000-51x Series Ball Valve Linkage Kit only)

M9000-51x Series Linkage Kits Used to Field Mount M9000 Series Electric

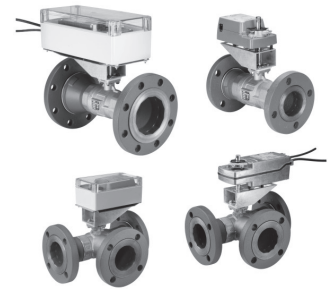

Repair Information

If the M9000-5xx Series Ball Valve Linkage Kit fails to operate within its specifications, replace the unit. For a replacement linkage kit, contact the nearest Johnson Controls® representative.

Selection Charts

Valid Ball Valve, Electric Actuator, and Linkage Kit Combinations for Field Assembly

Valve Size, in. (DN)	Valve Code Number	Actuator Base Number ¹	Linkage Kit Code Number	Optional Weathershield
2-1/2 (DN65)	VG12A5Gx, VG18A5Gx VG12A5Kx, VG18A5Kx	M9124	M9000-518	M9000-330
		M9220	M9000-519	M9000-340
3 (DN80)	VG12A5Hx, VG18A5Hx VG12A5Lx, VG18A5Lx	M9124	M9000-518	M9000-330
		M9220	M9000-519	M9000-340
4 (DN100)	VG12A5Jx, VG18A5Jx VG12A5MZ, VG18A5MZ	M9124	M9000-518	M9000-330
		M9220	M9000-519	M9000-340
5 (DN125)	VG12A5NY, VG18A5NY	M9124	M9000-518	M9000-330
		M9220	M9000-519	M9000-340
6 (DN150)	VG12A5PZ, VG18A5PZ	M9124	M9000-518	M9000-330
		M9220	M9000-519	M9000-340

1. M9124 Series are Non-Spring Return Actuators; M9220 Series are Spring-Return Actuators.

Linkages for Discontinued Series Ball Valves

Valve Size, in. (DN)	Valve Code Number	Actuator Base Number	Linkage Kit Code Number
1/2 (DN15)	VG1243Ax, VG1644Ax	VA9300	M9000-561
		VA9208	
3/4 (DN20)	VG1243BC, VG1644BB	VA9300	M9000-561
		VA9208	
1 (DN25)	VG1243CC, VG1644CB	M9124	M9000-518
		M9220	M9000-519
1-1/4 (DN32)	VG1643DC, VG1644DB	M9124	M9000-518
		M9220	M9000-519
2 (DN50)	VG1243EC, VG1644EB	M9124	M9000-518

Repair Parts

Repair Parts (Order Separately)

Code Number	Description
M9000-600	Anti-rotation slider; includes bracket, carriage screw, split lock washer, flat washer, and wing nut
M9000-601	Mounting screws and nuts; includes four M5 (5 mm) x 16 mm machine screws and four M5 (5 mm) serrated washer head nuts
M9000-602	Drive shaft

M9000-51x Series Ball Valve Linkage Kits (Continued)

Technical Specifications

M9000-51x Series Ball Valve Linkage Kits	
Service ¹	Hot water, chilled water, 50/50 glycol solutions, and low pressure steam
Maximum Actuator Fluid Temperature Limits	284°F (140°C)
Maximum Steam Service ²	15 psig saturated steam 250°F (121°C)
	25 psig saturated steam 267°F (130°C)
Minimum Ambient Operating Temperature	-40°F (-40°C)
	-4°F (-20°C)
Maximum Ambient Operating Temperature	122°F (50°C)
	131°F (55°C)
Material	Bracket: Aluminum
	Anti-Rotation Slider: 1018 Steel
	Drive Shaft: 12L14 Steel
	Standoff: Thermoplastic Resin
	Thermo-Isolator: PTFE (Polytetrafluoroethylene)
Shipping Weight	1.5 lb (0.68 kg)

1. Refer to VDI 2035 Guideline for proper water treatment.
2. In steam applications, install the valve with the stem horizontal to the piping, and wrap the valve and piping with insulation.



WARNING

This product is made of copper alloy, which contains lead. The product is therefore not to be used on drinking water.



WARNING

This product can expose you to chemicals including lead, which is known to the State of California to cause cancer, birth defects, or other reproductive harm. For more information, go to www.P65Warnings.ca.gov.

WARNING: BRASS MAY CONTAIN LEAD

To fulfill our obligations towards Article 33, in accordance to the European REACH Regulation No 1907/2006 EC, we hereby inform you that this article contains the following Substances of Very High Concern mentioned on the Candidate list:

- Lead

VP140 1/2 Inch to 2 Inch (DN15-DN50) Pressure Independent Control Valve

Description

VP140 Series Pressure Independent Valves (PICVs) are designed to regulate the flow of hot or chilled water and 50% glycol solutions in response to the demand of a controller in HVAC systems. The pressure independent valves eliminate the need for separate balancing valves. These valves are available in sizes 1/2 in. through 2 in. (DN15 through DN50) with factory-mounted Johnson Controls® Non-Spring Return and Spring Return Electric Actuators for floating or proportional control or valve only configuration.

Refer to the *VP140 1/2 Inch to 2 Inch (DN15-DN50) Pressure Independent Control Valve Product Bulletin, (LIT-12012610)* for important product application information.

Repair Information

If the VP140 Series Pressure Independent Control Valve fails to operate within its specifications, replace the unit. For a replacement, contact the nearest Johnson Controls® representative.

VP140 Series Pressure Independent Controller Valve



Features and Benefits

Features	Benefits
Availability of both axial (globe) and rotary (ball) valve styles	Application flexibility
No Cv calculation	Simplifies valve selection
Automatic system balancing	Prevents overflow or underflow to maximize system performance.
Combined control and Balancing valve	Reduces installation time and cost.
Close-off pressure rating - Axial valve 100 psi (700 kPa) and Rotary valve 200 psi (1,400 kPa)	Provides tight shutoff in high pressure systems.
Wide range of operating differential pressure rating	Allows use of valve in range of systems.
Availability of factory-mounted Electric Actuators	Reduces installation time and cost.
American National Standards Institute (ANSI) Class IV Leakage and ±5% Flow Accuracy	Reduces energy costs and provides superior room comfort.

⚠ WARNING

This product is made of copper alloy, which contains lead. The product is therefore not to be used on drinking water.

⚠ WARNING

This product can expose you to chemicals including lead, which is known to the State of California to cause cancer, birth defects, or other reproductive harm. For more information, go to www.P65Warnings.ca.gov.

WARNING: BRASS MAY CONTAIN LEAD

To fulfill our obligations towards Article 33, in accordance to the European REACH Regulation No 1907/2006 EC, we hereby inform you that this article contains the following Substances of Very High Concern mentioned on the Candidate list:

- Lead

VP140 1/2 Inch to 2 Inch (DN15-DN50) Pressure Independent Control Valve (Continued)

Ordering Information

Table 1: Axial (Globe) PICVs and Actuator Combinations

Valve Code Number	Size, in.	Maximum GPM	Close off pressure	24 VAC/DC Non-Spring Return Proportional DC 0 (2) to 10 V or 0 (4) to 20 mA VA-7482-8002-RA
VP140AAA	1/2	0.66	100 psi (700 kPa)	VP140AAA+778GGA
VP140AAE		2.6		VP140AAE+778GGA
VP140AAG		3.4		VP140AAG+778GGA
VP140BAJ	3/4	4.4		VP140BAJ+778GGA
VP140BAN		6.6		VP140BAN+778GGA
VP140BAU		9.7		VP140BAU+778GGA
VP140CAU	1	9.7		VP140CAU+778GGA
VP140CAW		11.9		VP140CAW+778GGA
VP140DAW	1-1/4	11.9		VP140DAW+778GGA
VP140DAY		13.2		VP140DAY+778GGA

Table 2: Brass Body Ball PICVs & NSR Actuator Combinations

Valve Code Number	Size, in.	Maximum GPM	Close off pressure	24 VAC	
				Non-Spring Return	
				Floating	Proportional DC 0 (2) to 10 V or 0 (4) to 20 mA
				VA9104-AGA-2S	VA9104-GGA-2S
VP140LCA	1/2	1.6	200 psi (1,400 kPa)	VP140LCA+9A4AGA	VP140LCA+9A4GGA
VP140LCB		3.0		VP140LCB+9A4AGA	VP140LCB+9A4GGA
VP140LAJ		4.4		VP140LAJ+9A4AGA	VP140LAJ+9A4GGA
VP140MAG	3/4	3.4		VP140MAG+9A4AGA	VP140MAG+9A4GGA
VP140MCC		5.0		VP140MCC+9A4AGA	VP140MCC+9A4GGA
VP140MAU		9.7		VP140MAU+9A4AGA	VP140MAU+9A4GGA
VP140NAU	1	9.7		VP140NAU+9A4AGA	VP140NAU+9A4GGA
VP140NAW		11.9		VP140NAW+9A4AGA	VP140NAW+9A4GGA
VP140PAY	1-1/4	13.2		VP140PAY+9A4AGA	VP140PAY+9A4GGA
VP140PCD		17.6		VP140PCD+9A4AGA	VP140PCD+9A4GGA

Table 3: Brass Body Ball PICVs & Spring Return Actuator Combinations

Valve Code Number	Size, in.	Maximum GPM	Close off pressure	24 VAC/VDC			
				Spring Opens		Spring Closes	
				On/Off and Floating	Proportional DC 0(12) to 10 V or 0 (4) to 20 mA	On/Off and Floating	Proportional DC 0(12) to 10 V or 0 (4) to 20 mA
				VA9203-AGA-2Z	VA9203-GGA-2Z	VA9203-AGA-2Z	VA9203-GGA-2Z
VP140LCA	1/2	1.6	200 psi (1,400 kPa)	VP140LCA+923AGA	VP140LCA+923GGA	VP140LCA+943AGA	VP140LCA+943GGA
VP140LCB		3.0		VP140LCB+923AGA	VP140LCB+923GGA	VP140LCB+943AGA	VP140LCB+943GGA
VP140LAJ		4.4		VP140LAJ+923AGA	VP140LAJ+923GGA	VP140LAJ+943AGA	VP140LAJ+943GGA
VP140MAG	3/4	3.4		VP140MAG+923AGA	VP140MAG+923GGA	VP140MAG+943AGA	VP140MAG+943GGA
VP140MCC		5.0		VP140MCC+923AGA	VP140MCC+923GGA	VP140MCC+943AGA	VP140MCC+943GGA
VP140MAU		9.7		VP140MAU+923AGA	VP140MAU+923GGA	VP140MAU+943AGA	VP140MAU+943GGA
VP140NAU	1	9.7		VP140NAU+923AGA	VP140NAU+923GGA	VP140NAU+943AGA	VP140NAU+943GGA
VP140NAW		11.9		VP140NAW+923AGA	VP140NAW+923GGA	VP140NAW+943AGA	VP140NAW+943GGA
VP140PAY	1-1/4	13.2		VP140PAY+923AGA	VP140PAY+923GGA	VP140PAY+943AGA	VP140PAY+943GGA
VP140PCD		17.6		VP140PCD+923AGA	VP140PCD+923GGA	VP140PCD+943AGA	VP140PCD+943GGA

The performance specifications are nominal and conform to acceptable industry standards. For applications at conditions beyond these specifications, consult the local Johnson Controls office. Johnson Controls shall not be liable for damages resulting from misapplication or misuse of its products. © 2019 Johnson Controls. www.johnsoncontrols.com

VP140 1/2 Inch to 2 Inch (DN15-DN50) Pressure Independent Control Valve (Continued)

Table 4: Iron Body Ball PICVs Actuator Combinations

Valve Code Number	Size, in.	Maximum GPM	Close off pressure	24 VAC/DC		
				Non-Spring Return	Spring Opens	Spring Closes
				Universal Input for On/Off, Floating and Proportional 0 (2) to 10 VDC with Adjustable Span	Proportional DC 0 (2) to 10 V or 0 (4) to 20 mA	Proportional DC 0 (2) to 10 V or 0 (4) to 20 mA
				VA9310-HGA-2	VA9208-GGA-2	VA9208-GGA-2
VP140QBB	1-1/4	26.4	200 psi (1,400 kPa)	VP140QBB+910HGA	VP140QBB+928GGA	VP140QBB+948GGA
VP140EBB	1-1/2	26.4		VP140EBB+910HGA	VP140EBB+928GGA	VP140EBB+948GGA
VP140EBC	2	39.6		VP140EBC+910HGA	VP140EBC+928GGA	VP140EBC+948GGA
VP140FBD		48.4		VP140FBD+910HGA	VP140FBD+928GGA	VP140FBD+948GGA
VP140FBE	52.8	VP140FBE+910HGA		VP140FBE+928GGA	VP140FBE+948GGA	
VP140FBF	79.3	VP140FBF+910HGA		VP140FBF+928GGA	VP140FBF+948GGA	

Table 5: Actuators

Code Number	Valve Compatibility	Spring Return	Proportional Control DC 0 (2) to 10 V or 0 (4) to 20 mA	Floating Point Control	Adjustable Span	Universal Input for On/Off	24 VAC/VDC	24 VAC
VA-7482-8002-RA	Axial (Globe)	No	Yes	No	No	No	Yes	No
VA9104-AGA-2S	Brass Body Ball Valves	No	No	Yes	No	No	No	Yes
VA9104-GGA-2S		No	Yes	No	No	No	No	Yes
VA9203-AGA-2Z		Yes	No	Yes	No	Yes	Yes	No
VA9203-GGA-2Z		Yes	Yes	No	No	No	Yes	No
VA9310-HGA-2	Iron Body Ball Valves	No	Yes	Yes	Yes	Yes	Yes	No
VA9208-GGA-2		Yes	Yes	No	No	No	Yes	No

For actuator technical specifications, refer to the following:

- VA-748x Electric Valve Actuators (LIT-1900866)
- VA9104 Series Electric Non-Spring Return Valve Actuators (LIT-1900354)
- VA9203-xxx-xx Series Electric Spring-Return Actuators (LIT-1900692)
- VA9300 Series Electric Non-Spring Return Valve Actuators (LIT-1901002)
- VA9208-xxx-xx Series Electric Spring-Return Actuators (LIT-1900648)

Table 6: Accessories

Code Number	Description
M9000-342	Weather shield kit for VA9203 or VA9104 Series Electric Actuators (quantity 1)

VP140 1/2 Inch to 2 Inch (DN15-DN50) Pressure Independent Control Valve (Continued)

Valve Technical Specifications

Table 6: Axial (Globe) PICVs

Service ¹		Water or water-glycol mixture, (up to 50% glycol) quality to VDI 2035
Accuracy up to 15 PSID (100 kPa)		± 5%
Fluid Temperature Limits		14°F to 248 °F (-10°C to 120 °C), Not Rated for Steam Service
Maximum Actuator Fluid Temperature Limit		14°F to 212 °F (-10°C to 100 °C), Not Rated for Steam Service
Maximum ΔP		87 psi (600 kPa)
Maximum working pressures		362 psi (2,500 kPa)
Close off pressure		100 psi (700 kPa)
Minimum ΔP for start-up	VP140AAA	2.9 psi (20 kPa)
	VP140AAE	3.6 psi (25 kPa)
	VP140AAG	5.1 psi (35 kPa)
	VP140BAJ	4.4 psi (30 kPa)
	VP140BAN	5.1 psi (35 kPa)
	VP140BAU	3.6 psi (25 kPa)
	VP140CAU	4.4 psi (30 kPa)
	VP140CAW	
	VP140DAW	5.1 psi (35 kPa)
VP140DAY		
Maximum Flow Rate	VP140AAA	0.66 GPM (150 l/h)
	VP140AAE	2.6 GPM (600 l/h)
	VP140AAG	3.4 GPM (780 l/h)
	VP140BAJ	4.4 GPM (1,000 l/h)
	VP140BAN	6.6 GPM (1,500 l/h)
	VP140BAU	9.7 GPM (2,200 l/h)
	VP140CAU	11.9 GPM (2,700 l/h)
	VP140CAW	
	VP140DAW	13.2 GPM (3,000 l/h)
VP140DAY		
Connection	VP140AAA	1/2 inch female NPT
	VP140AAE	
	VP140AAG	
	VP140BAJ	3/4 inch female NPT
	VP140BAN	
	VP140BAU	3/4 inch female NPT Union
	VP140CAU	1 inch female NPT Union
	VP140CAW	1 1/4 inch female NPT Union
	VP140DAW	
VP140DAY		
Minimum Ambient Operating Conditions	VA-7482-8002-RA	32 °F (0 °C), 90% RH, Noncondensing
Maximum Ambient Operating Conditions (limited by the actuator)	VA-7482-8002-RA	122 °F (50 °C), 90% RH, Noncondensing
Materials	Body forging	DZR Brass CW602N
	Cartridge body	PSU
	Cartridge seat	Brass CW614N
	Cartridge spring	Stainless steel AISI 302
	Cartridge shutter	Stainless steel AISI 303
	Diaphragm EPDM	EPDM
	Globe	Brass CW614N
	Hand-wheel	PSU (Polysulfone)
	Headwork cap	ABS
	Headwork pin	Stainless steel AISI 303
	All o-rings	EPDM
	Pre-setting seat	Brass CW614N
	Valve headwork	Brass CW614N
Leakage	ANSI Class IV IEC 60534-4 American National Standards Institute (ANSI) Class IV Leakage	
Compliance 	Johnson Controls declares that this product is in compliance with the essential requirements and other relevant provisions of the PED (Pressure Equipment Directive) Service	

1. Johnson Controls does not accept any liability for improper or wrong use of this product. Proper water treatment is recommended; refer to the VDI 2035 Guideline. Furthermore, maximum iron oxide in the water passing through the control valve (PICV) should not exceed 25 mg/Kg (25 ppm). To ensure the main pipework is cleaned appropriately, flushing by-passes should be used without flushing through the pressure regulator of the Pressure Independent Control Valve. The performance specifications are nominal and conform to acceptable industry standards. For applications at conditions beyond these specifications, consult the local Johnson Controls office. Johnson Controls shall not be liable for damages resulting from misapplication or misuse of its products. © 2019 Johnson Controls. www.johnsoncontrols.com

VP140 1/2 Inch to 2 Inch (DN15-DN50) Pressure Independent Control Valve (Continued)

Table 7: Brass Body Ball PICVs

Service ¹		Water or water-glycol mixture, (up to 50% glycol) quality to VDI 2035
Accuracy up to 15 PSID (100 kPa)		± 5%
Fluid Temperature Limits		14°F to 248°F (-10°C to 120°C), Not Rated for Steam Service
Maximum Actuator Fluid Temperature Limit		14°F to 212°F (-10°C to 100°C), Not Rated for Steam Service
Maximum ΔP		58 psi (400 kPa)
Maximum working pressure		360 psi (2,500 kPa)
Close off pressure		200 psi (1,400 kPa)
Minimum ΔP for start-up	VP140LCA	2.9 psi (20 kPa)
	VP140LCB	
	VP140LAJ	
	VP140MAG	3.6 psi (25 kPa)
	VP140MCC	
	VP140MAU	4.4 psi (30 kPa)
	VP140NAU	
	VP140NAW	
	VP140PAY	
Maximum Flow Rate	VP140LCA	1.6 GPM (360 l/h)
	VP140LCB	3.0 GPM (600 l/h)
	VP140LAJ	4.4 GPM (1,000 l/h)
	VP140MAG	3.4 GPM (780 l/h)
	VP140MCC	5.0 GPM (1,150 l/h)
	VP140MAU	9.7 GPM (2,200 l/h)
	VP140NAU	
	VP140NAW	11.9 GPM (2,700 l/h)
	VP140PAY	13.2 GPM (3,000 l/h)
Connection	VP140LCA	1/2 inch female NPT
	VP140LCB	
	VP140LAJ	
	VP140MAG	3/4 inch female NPT
	VP140MCC	
	VP140MAU	3/4 inch female NPT Union
	VP140NAU	1 inch female NPT Union
	VP140NAW	
	VP140PAY	1 1/4 inch female NPT Union
Minimum Ambient Operating Conditions	VA9104-AGA-2S	-4°F (-20°C), 90% RH, Noncondensing
	VA9104-GGA-2S	
	VA9203-AGA-2Z	-22°F (-30°C), 90% RH, Noncondensing
	VA9203-GGA-2Z	
Maximum Ambient Operating Conditions (limited by the actuator)	VA9104-AGA-2S	
	VA9104-GGA-2S	140°F (60°C), 90% RH, Noncondensing
	VA9203-AGA-2Z	
	VA9203-GGA-2Z	
Materials	Body forging	DZR Brass CW602N
	Cartridge body	Brass CW614N
	Cartridge seat	Brass CW614N
	Cartridge spring	Stainless Steel AISI 302
	Diaphragm	EPDM
	Ball	Chrome Plated Brass CW617N
	Stem	Brass CW614N
	Stem o-rings	Viton
Leakage		ANSI Class IV IEC 60534-4 American National Standards Institute (ANSI) Class IV Leakage
Compliance		Johnson Controls declares that this product is in compliance with the essential requirements and other relevant provisions of the PED (Pressure Equipment Directive) Service
		

1. Johnson Controls does not accept any liability for improper or wrong use of this product. Proper water treatment is recommended; refer to the VDI 2035 Guideline. Furthermore, maximum iron oxide in the water passing through the control valve (PICV) should not exceed 25 mg/Kg (25 ppm). To ensure the main pipework is cleaned appropriately, flushing by-passes should be used without flushing through the pressure regulator of the Pressure Independent Control Valve.

VP140 1/2 Inch to 2 Inch (DN15-DN50) Pressure Independent Control Valve (Continued)

Table 8: Iron Body Ball PICVs

Service¹		Water or water-glycol mixture, (up to 50% glycol) quality to VDI 2035
Accuracy up to 15 PSID, 100 kPa		± 5%
Fluid Temperature Limits		14°F to 248°F (-10°C to 120°C), Not Rated for Steam Service
Maximum Actuator Fluid Temperature Limit		14°F to 212°F (-10°C to 100°C), Not Rated for Steam Service
Maximum ΔP		87 psi (600 kPa)
Maximum working pressure		232 psi (1,600 kPa)
Close off pressure		200 psi (1,400 kPa)
Minimum ΔP for start-up	VP140 QBB	4.4 psi (30 kPa)
	VP140 EBB	
	VP140 EBC	5.1 psi (35 kPa)
	VP140 FBD	5.8 psi (40 kPa)
	VP140 FBE	5.1 psi (35 kPa)
	VP140 FBF	
Maximum Flow Rate	VP140 QBB	26.4 GPM (6,000 l/h)
	VP140 EBB	
	VP140 EBC	39.6 GPM (9,000 l/h)
	VP140 FBD	48.4 GPM (11,000 l/h)
	VP140 FBE	52.8 GPM (12,000 l/h)
	VP140 FBF	79.3 GPM (18,000 l/h)
Connection	VP140 QBB	1-1/4 inch female NPT Union
	VP140 EBB	1-1/2 inch female NPT Union
	VP140 EBC	
	VP140 FBD	2 inch female NPT Union
	VP140 FBE	
	VP140 FBF	
Minimum Ambient Operating Conditions	VA9310-HGA-2	-20°F (-30°C), 95% RH, Noncondensing
	VA9208-GGA-2	-40°F (-40°C), 95% RH, Noncondensing
Maximum Ambient Operating Conditions (limited by the actuator)	VA9310-HGA-2	140°F (60°C), 95% RH, Noncondensing
	VA9208-GGA-2	140°F (60°C), 95% RH, Noncondensing
Materials	Ball	Chrome Plated Brass CW617N
	Cartridge	High resistance polymer - EPDM Stainless steel AISI 303
	Presetting	Brass CW617N
	Body	Ductile Iron
	Gaskets	EPDM-x
	Additional manual shut-off device	Brass CW614N
	Stem	Brass CW614N
	Stem o-rings	Viton
Leakage	ANSI Class IV IEC 60534-4 American National Standards Institute (ANSI) Class IV Leakage	
Compliance 	Johnson Controls, declares that this product is in compliance with the essential requirements and other relevant provisions of the PED (Pressure Equipment Directive) Service	

1. Johnson Controls does not accept any liability for improper or wrong use of this product. Proper water treatment is recommended; refer to the VDI 2035 Guideline. Furthermore, maximum iron oxide in the water passing through the control valve (PICV) should not exceed 25 mg/Kg (25 ppm). To ensure the main pipework is cleaned appropriately, flushing by-passes should be used without flushing through the pressure regulator of the Pressure Independent Control Valve.

VG7000 Series Brass Trim Globe Valves with VA-715x Series Electric Actuators

Description

VG7000 Series Brass Trim Globe Valves with VA-715x Series Non-Spring-Return Electric Actuators control hot or chilled water, or steam.

Refer to the *VG7000 Series Bronze Control Valves Product Bulletin (LIT-977140)* for important product application information.

Features

- 90 lb force provides tight closeoff
- direct coupled no linkage required
- magnetic clutch protects gearing, ensures tight closeoff

- controls hot water, chilled water, or steam
- fits VG7000 Series valves 1/2 through 2 in.
- valve body static pressure rating: ANSI Class 250
- factory or field assembly
- voltage: 24 VAC, 50/60 Hz, 4.7 VA

Repair Information

If the VG7000 Series Globe Valve fails to operate within its specifications, replace the valve body, actuator, or entire assembly. For replacement parts, contact the nearest Johnson Controls® representative.

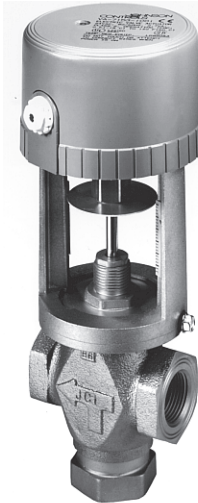

VA-715x Series Electric Actuator Mounted on a VG7842 Brass Globe Valve

WARNING

This product can expose you to chemicals including lead, which is known to the State of California to cause cancer, birth defects, or other reproductive harm. For more information, go to www.P65Warnings.ca.gov.

WARNING

This product is made of copper alloy, which contains lead. The product is therefore not to be used on drinking water.

Selection Chart

VG7000 Brass Trim Globe Valve with VA-715x Series Non-Spring-Return Electric Actuator (Part 1 of 2)

Actuator Code Number				VA-7150-1001	VA-7153-1001	VA-7152-1001
Actuator Input				On/Off (Floating)	On/Off (Floating) with Feedback	0 to 10 VDC Proportional
Temperature Range				35°F to 284°F Fluid Temperature, 38 psig Saturated Steam		
Valve Code Number	Size, in.	Cv	Closeoff psig	Non-Spring Return		
Two-Way Push-Down-to-Close — NPT End Connections						
VG7241CT	1/2	0.73	345	VG7241CT+7150G	VG7241CT+7153G	VG7241CT+7152G
VG7241ET	1/2	1.8	345	VG7241ET+7150G	VG7241ET+7153G	VG7241ET+7152G
VG7241GT	1/2	4.6	216	VG7241GT+7150G	VG7241GT+7153G	VG7241GT+7152G
VG7241LT	3/4	7.3	138	VG7241LT+7150G	VG7241LT+7153G	VG7241LT+7152G
VG7241NT	1	11.6	86	VG7241NT+7150G	VG7241NT+7153G	VG7241NT+7152G
VG7241PT	1-1/4	18.5	52	VG7241PT+7150G	VG7241PT+7153G	VG7241PT+7152G
VG7241RT	1-1/2	28.9	34	VG7241RT+7150G	VG7241RT+7153G	VG7241RT+7152G
VG7241ST	2	46.2	21	VG7241ST+7150G	VG7241ST+7153G	VG7241ST+7152G
Three-Way Mixing — NPT End Connections						
VG7842CT	1/2	0.73	345/345	VG7842CT+7150G	VG7842CT+7153G	VG7842CT+7152G
VG7842ET	1/2	1.8	345/345	VG7842ET+7150G	VG7842ET+7153G	VG7842ET+7152G
VG7842GT	1/2	4.6	216/257	VG7842GT+7150G	VG7842GT+7153G	VG7842GT+7152G
VG7842LT	3/4	7.3	138/153	VG7842LT+7150G	VG7842LT+7153G	VG7842LT+7152G
VG7842NT	1	11.6	86/100	VG7842NT+7150G	VG7842NT+7153G	VG7842NT+7152G
VG7842PT	1-1/4	18.5	52/57	VG7842PT+7150G	VG7842PT+7153G	VG7842PT+7152G
VG7842RT	1-1/2	28.9	34/36	VG7842RT+7150G	VG7842RT+7153G	VG7842RT+7152G
VG7842ST	2	46.2	21/22	VG7842ST+7150G	VG7842ST+7153G	VG7842ST+7152G
Two-Way Push-Down-to-Close — Union Sweat End Connections						
VG7281CT	1/2	0.73	345	VG7281CT+7150G	VG7281CT+7153G	VG7281CT+7152G
VG7281ET	1/2	1.8	345	VG7281ET+7150G	VG7281ET+7153G	VG7281ET+7152G
VG7281GT	1/2	4.6	216	VG7281GT+7150G	VG7281GT+7153G	VG7281GT+7152G
VG7281LT	3/4	7.3	138	VG7281LT+7150G	VG7281LT+7153G	VG7281LT+7152G
VG7281NT	1	11.6	86	VG7281NT+7150G	VG7281NT+7153G	VG7281NT+7152G
VG7281PT	1-1/4	18.5	52	VG7281PT+7150G	VG7281PT+7153G	VG7281PT+7152G
VG7281RT	1-1/2	28.9	34	VG7281RT+7150G	VG7281RT+7153G	VG7281RT+7152G
VG7281ST	2	46.2	21	VG7281ST+7150G	VG7281ST+7153G	VG7281ST+7152G

VG7000 Series Brass Trim Globe Valves with VA-715x Series Electric Actuators

VG7000 Brass Trim Globe Valve with VA-715x Series Non-Spring-Return Electric Actuator (Part 2 of 2)

Actuator Code Number				VA-7150-1001	VA-7153-1001	VA-7152-1001
Actuator Input				On/Off (Floating)	On/Off (Floating) with Feedback	0 to 10 VDC Proportional
Temperature Range				35°F to 284°F Fluid Temperature, 38 psig Saturated Steam		
Valve Code Number	Size, in.	Cv	Closeoff psig	Non-Spring Return		
Three-Way Mixing — Union Sweat End Connections						
VG7882CT	1/2	0.73	345/345	VG7882CT+7150G	VG7882CT+7153G	VG7882CT+7152G
VG7882ET	1/2	1.8	345/345	VG7882ET+7150G	VG7882ET+7153G	VG7882ET+7152G
VG7882GT	1/2	4.6	216/257	VG7882GT+7150G	VG7882GT+7153G	VG7882GT+7152G
VG7882LT	3/4	7.3	138/153	VG7882LT+7150G	VG7882LT+7153G	VG7882LT+7152G
VG7882NT	1	11.6	86/100	VG7882NT+7150G	VG7882NT+7153G	VG7882NT+7152G
VG7882PT	1-1/4	18.5	52/57	VG7882PT+7150G	VG7882PT+7153G	VG7882PT+7152G
VG7882RT	1-1/2	28.9	34/36	VG7882RT+7150G	VG7882RT+7153G	VG7882RT+7152G
VG7882ST	2	46.2	21/22	VG7882ST+7150G	VG7882ST+7153G	VG7882ST+7152G
Two-Way Push-Down-to-Close — 3/8 in. Union Sweat End Connections						
VG7271CT	1/2	0.73	345	VG7271CT+7150G	VG7271CT+7153G	VG7271CT+7152G
VG7271ET	1/2	1.8	345	VG7271ET+7150G	VG7271ET+7153G	VG7271ET+7152G
VG7271GT	1/2	4.6	216	VG7271GT+7150G	VG7271GT+7153G	VG7271GT+7152G
Three-Way Mixing — 3/8 in. Union Sweat End Connections						
VG7872CT	1/2	0.73	345/345	VG7872CT+7150G	VG7872CT+7153G	VG7872CT+7152G
VG7872ET	1/2	1.8	345/345	VG7872ET+7150G	VG7872ET+7153G	VG7872ET+7152G
VG7872GT	1/2	4.6	216/257	VG7872GT+7150G	VG7872GT+7153G	VG7872GT+7152G
Two-Way Push-Down-to-Close — 3/4 in. Union Sweat End Connections						
VG7291CT	1/2	0.73	345	VG7291CT+7150G	VG7291CT+7153G	VG7291CT+7152G
VG7291ET	1/2	1.8	345	VG7291ET+7150G	VG7291ET+7153G	VG7291ET+7152G
VG7291GT	1/2	4.6	216	VG7291GT+7150G	VG7291GT+7153G	VG7291GT+7152G
Three-Way Mixing — 3/4 in. Union Sweat End Connections						
VG7892CT	1/2	0.73	345/345	VG7892CT+7150G	VG7892CT+7153G	VG7892CT+7152G
VG7892ET	1/2	1.8	345/345	VG7892ET+7150G	VG7892ET+7153G	VG7892ET+7152G
VG7892GT	1/2	4.6	216/257	VG7892GT+7150G	VG7892GT+7153G	VG7892GT+7152G
Two-Way Push-Down-to-Close — Union Globe End Connections						
VG7251CT	1/2	0.73	345	VG7251CT+7150G	VG7251CT+7153G	VG7251CT+7152G
VG7251ET	1/2	1.8	345	VG7251ET+7150G	VG7251ET+7153G	VG7251ET+7152G
VG7251GT	1/2	4.6	216	VG7251GT+7150G	VG7251GT+7153G	VG7251GT+7152G
VG7251LT	3/4	7.3	138	VG7251LT+7150G	VG7251LT+7153G	VG7251LT+7152G
VG7251NT	1	11.6	86	VG7251NT+7150G	VG7251NT+7153G	VG7251NT+7152G
VG7251PT	1-1/4	18.5	52	VG7251PT+7150G	VG7251PT+7153G	VG7251PT+7152G
VG7251RT	1-1/2	28.9	34	VG7251RT+7150G	VG7251RT+7153G	VG7251RT+7152G
Two-Way Push-Down-to-Close — Union Angle End Connections						
VG7551CT	1/2	0.73	345	VG7551CT+7150G	VG7551CT+7153G	VG7551CT+7152G
VG7551ET	1/2	1.8	345	VG7551ET+7150G	VG7551ET+7153G	VG7551ET+7152G
VG7551GT	1/2	4.6	216	VG7551GT+7150G	VG7551GT+7153G	VG7551GT+7152G
VG7551LT	3/4	7.3	138	VG7551LT+7150G	VG7551LT+7153G	VG7551LT+7152G
VG7551NT	1	11.6	86	VG7551NT+7150G	VG7551NT+7153G	VG7551NT+7152G
VG7551PT	1-1/4	18.5	52	VG7551PT+7150G	VG7551PT+7153G	VG7551PT+7152G
VG7551RT	1-1/2	28.9	34	VG7551RT+7150G	VG7551RT+7153G	VG7551RT+7152G

VG7000 Series Brass Trim Globe Valves with VA-715x Series Electric Actuators

Technical Specifications

VG7000 Series Brass Trim Globe Valves with VA-715x Series Electric Actuators		
Service¹		Hot Water, Chilled Water, 50/50 Glycol Solutions, and Steam for HVAC Systems
Fluid Temperature Limits	Water	35°F to 284°F (2°C to 140°C)
	Steam	38 psig (262 kPa) Saturated Steam
Maximum Allowable Pressure/Temperature	Water	400 psig (2,756 kPa) up to 150°F (66°C) Decreasing to 365 psig (2,515 kPa) at 248°F (120°C)
	Steam	38 psig (262 kPa) Saturated Steam at 284°F (140°C)
Valve Body Pressure/Temperature Rating		Meets Requirements of ANSI B16.15, Class 250
Maximum Recommended Operating Pressure Drop	Water	35 psig (241 kPa) for 1/2 through 1-1/4 in. Valves 30 psig (207 kPa) for 1-1/2 and 2 in. Valves
	Steam	15 psig (103 kPa)
Flow Characteristics	Two-Way Valves	Equal Percentage
	Three-Way Valves	Linear Flow Characteristics
Rangeability²		> 25:1 According to EN60534-2-4 for the 1/2 in. Size, Cv 0.73, Valve Bodies > 100:1 According to EN60534-2-4 for All Other Valves
Leakage		0.01% of Maximum Flow per ANSI/FCI 70-2, Class 4
Actuator Ambient Operating Temperature Limits		0°F to 140°F (-18°C to 60°C)
Actuator Input Signal	VA-7150-1001	24 VAC Three-Wire Floating Control
	VA-7152-1001	0 to 10 VDC Proportional Control
	VA-7153-1001	24 VAC Three-Wire Floating Control with 0 to 2,000 Ohm Feedback Potentiometer for 25/32 in. Valve Stroke
Actuator Power Requirements	VA-7150-1001	24 VAC (20 to 30 VAC), 50/60 Hz, 2.7 VA Nominal
	VA-7152-1001	24 VAC (20 to 30 VAC), 50/60 Hz, 4.7 VA Nominal
	VA-7153-1001	24 VAC (20 to 30 VAC), 50/60 Hz, 2.7 VA Nominal
Materials	Body	Cast Bronze
	Bonnet	Brass
	Stem	Stainless Steel
	Plug	Brass
	Seat	Brass against Molded Elastomeric Disk
	Packing	Self-Adjusting Ethylene Propylene Rubber (EPR) Ring Pack U-Cups
Compliance	Canada	CRN: 0C1099.9087YTN

1. Refer to the VDI 2035 Guideline for recommended proper water treatment.

2. Rangeability is defined as the ratio of maximum controllable flow to minimum controllable flow.

WARNING: BRASS MAY CONTAIN LEAD

To fulfill our obligations towards Article 33, in accordance to the European REACH Regulation No 1907/2006 EC, we hereby inform you that this article contains the following Substances of Very High Concern mentioned on the Candidate list:

- Lead

VG7000 Series Brass Trim Globe Valves with VA-4233 Series Spring-Return Electric Actuators

Description

VG7000 Series Brass Trim Globe Valves with VA-4233 Series Spring-Return Electric Actuators control hot or chilled water, or steam.

Refer to the *VG7000 Series Bronze Control Valves Product Bulletin (LIT-977140)* for important product application information.

Features

- spring return stem up
- 61 lb force provides tight shutoff
- manual opener
- fits VG7000 Series valves 1/2 through 1-1/4 in.

- valve body static pressure rating: ANSI Class 250
- optional auxiliary switches available
- factory or field assembly
- voltage: 20 VAC to 30 VAC, 50/60 Hz, 12 VA

Repair Information

If the VG7000 Series Globe Valve fails to operate within its specifications, replace the valve body, actuator, or entire assembly. For replacement parts, contact the nearest Johnson Controls® representative.



**VA-4233 Electric Actuator
Mounted on a VG7441 Brass Globe Valve**

WARNING

This product is made of copper alloy, which contains lead. The product is therefore not to be used on drinking water.

WARNING

This product can expose you to chemicals including lead, which is known to the State of California to cause cancer, birth defects, or other reproductive harm. For more information, go to www.P65Warnings.ca.gov.

Selection Charts

VG7000 Series Brass Trim Globe Valve Assemblies with VA-4233 Series Spring-Return Electric Actuators, Less Auxiliary Switches (Part 1 of 2)

Actuator Code Number				VA-4233-AGA-2	VA-4233-BGA-2	VA-4233-GGA-2
Actuator Input				Floating	On/Off	0 VDC to 10 VDC Proportional
Temperature Range				35°F to 250°F (2°C to 121°C), 15 psig Saturated Steam		
Valve Code Number	Size, in.	Cv	Closeoff psig	Spring Return Stem Up		
Two-Way Push-Down-to-Close — NPT End Connections						
VG7241CT	1/2	0.73	345	VG7241CT+423AGA	VG7241CT+423BGA	VG7241CT+423GGA
VG7241ET	1/2	1.8	345	VG7241ET+423AGA	VG7241ET+423BGA	VG7241ET+423GGA
VG7241GT	1/2	4.6	208	VG7241GT+423AGA	VG7241GT+423BGA	VG7241GT+423GGA
VG7241LT	3/4	7.3	132	VG7241LT+423AGA	VG7241LT+423BGA	VG7241LT+423GGA
VG7241NT	1	11.6	63	VG7241NT+423AGA	VG7241NT+423BGA	VG7241NT+423GGA
VG7241PT	1-1/4	18.5	38	VG7241PT+423AGA	VG7241PT+423BGA	VG7241PT+423GGA
Two-Way Push-Down-to-Open — NPT End Connections						
VG7441CT	1/2	0.73	345	VG7441CT+423AGA	VG7441CT+423BGA	VG7441CT+423GGA
VG7441ET	1/2	1.8	345	VG7441ET+423AGA	VG7441ET+423BGA	VG7441ET+423GGA
VG7441GT	1/2	4.6	173	VG7441GT+423AGA	VG7441GT+423BGA	VG7441GT+423GGA
VG7441LT	3/4	7.3	103	VG7441LT+423AGA	VG7441LT+423BGA	VG7441LT+423GGA
VG7441NT	1	11.6	66	VG7441NT+423AGA	VG7441NT+423BGA	VG7441NT+423GGA
VG7441PT	1-1/4	18.5	38	VG7441PT+423AGA	VG7441PT+423BGA	VG7441PT+423GGA
Three-Way Mixing — NPT End Connections						
VG7842CT	1/2	0.73	345/345	VG7842CT+423AGA	VG7842CT+423BGA	VG7842CT+423GGA
VG7842ET	1/2	1.8	345/345	VG7842ET+423AGA	VG7842ET+423BGA	VG7842ET+423GGA
VG7842GT	1/2	4.6	208/173	VG7842GT+423AGA	VG7842GT+423BGA	VG7842GT+423GGA
VG7842LT	3/4	7.3	132/103	VG7842LT+423AGA	VG7842LT+423BGA	VG7842LT+423GGA
VG7842NT	1	11.6	63/66	VG7842NT+423AGA	VG7842NT+423BGA	VG7842NT+423GGA
VG7842PT	1-1/4	18.5	38/38	VG7842PT+423AGA	VG7842PT+423BGA	VG7842PT+423GGA
Two-Way Push-Down-to-Close — Union Sweat End Connections						
VG7281CT	1/2	0.73	345	VG7281CT+423AGA	VG7281CT+423BGA	VG7281CT+423GGA
VG7281ET	1/2	1.8	345	VG7281ET+423AGA	VG7281ET+423BGA	VG7281ET+423GGA
VG7281GT	1/2	4.6	208	VG7281GT+423AGA	VG7281GT+423BGA	VG7281GT+423GGA
VG7281LT	3/4	7.3	132	VG7281LT+423AGA	VG7281LT+423BGA	VG7281LT+423GGA
VG7281NT	1	11.6	63	VG7281NT+423AGA	VG7281NT+423BGA	VG7281NT+423GGA

VG7000 Series Brass Trim Globe Valves with VA-4233 Series Spring-Return Electric Actuators (Continued)

VG7000 Series Brass Trim Globe Valve Assemblies with VA-4233 Series Spring-Return Electric Actuators, Less Auxiliary Switches (Part 2 of 2)

Actuator Code Number				VA-4233-AGA-2	VA-4233-BGA-2	VA-4233-GGA-2
Actuator Input				Floating	On/Off	0 VDC to 10 VDC Proportional
Temperature Range				35°F to 250°F (2°C to 121°C), 15 psig Saturated Steam		
Valve Code Number	Size, in.	Cv	Closeoff psig	Spring Return Stem Up		
VG7281PT	1-1/4	18.5	38	VG7281PT+423AGA	VG7281PT+423BGA	VG7281PT+423GGA
Two-Way Push-Down-to-Open — Union Sweat End Connections						
VG7481CT	1/2	0.73	345	VG7481CT+423AGA	VG7481CT+423BGA	VG7481CT+423GGA
VG7481ET	1/2	1.8	345	VG7481ET+423AGA	VG7481ET+423BGA	VG7481ET+423GGA
VG7481GT	1/2	4.6	173	VG7481GT+423AGA	VG7481GT+423BGA	VG7481GT+423GGA
VG7481LT	3/4	7.3	103	VG7481LT+423AGA	VG7481LT+423BGA	VG7481LT+423GGA
VG7481NT	1	11.6	66	VG7481NT+423AGA	VG7481NT+423BGA	VG7481NT+423GGA
VG7481PT	1-1/4	18.5	38	VG7481PT+423AGA	VG7481PT+423BGA	VG7481PT+423GGA
Three-Way Mixing — Union Sweat End Connections						
VG7882CT	1/2	0.73	345/345	VG7882CT+423AGA	VG7882CT+423BGA	VG7882CT+423GGA
VG7882ET	1/2	1.8	345/345	VG7882ET+423AGA	VG7882ET+423BGA	VG7882ET+423GGA
VG7882GT	1/2	4.6	208/173	VG7882GT+423AGA	VG7882GT+423BGA	VG7882GT+423GGA
VG7882LT	3/4	7.3	132/103	VG7882LT+423AGA	VG7882LT+423BGA	VG7882LT+423GGA
VG7882NT	1	11.6	63/66	VG7882NT+423AGA	VG7882NT+423BGA	VG7882NT+423GGA
VG7882PT	1-1/4	18.5	38/38	VG7882PT+423AGA	VG7882PT+423BGA	VG7882PT+423GGA
Two-Way Push-Down-to-Close — 3/8 in. Union Sweat End Connections						
VG7271CT	1/2	0.73	345	VG7271CT+423AGA	VG7271CT+423BGA	VG7271CT+423GGA
VG7271ET	1/2	1.8	345	VG7271ET+423AGA	VG7271ET+423BGA	VG7271ET+423GGA
VG7271GT	1/2	4.6	208	VG7271GT+423AGA	VG7271GT+423BGA	VG7271GT+423GGA
Two-Way Push-Down-to-Open — 3/8 in. Union Sweat End Connections						
VG7471CT	1/2	0.73	345	VG7471CT+423AGA	VG7471CT+423BGA	VG7471CT+423GGA
VG7471ET	1/2	1.8	345	VG7471ET+423AGA	VG7471ET+423BGA	VG7471ET+423GGA
VG7471GT	1/2	4.6	173	VG7471GT+423AGA	VG7471GT+423BGA	VG7471GT+423GGA
Three-Way Mixing — 3/8 in. Union Sweat End Connections						
VG7872CT	1/2	0.73	345/345	VG7872CT+423AGA	VG7872CT+423BGA	VG7872CT+423GGA
VG7872ET	1/2	1.8	345/345	VG7872ET+423AGA	VG7872ET+423BGA	VG7872ET+423GGA
VG7872GT	1/2	4.6	208/173	VG7872GT+423AGA	VG7872GT+423BGA	VG7872GT+423GGA
Two-Way Push-Down-to-Close — 3/4 in. Union Sweat End Connections						
VG7291CT	1/2	0.73	345	VG7291CT+423AGA	VG7291CT+423BGA	VG7291CT+423GGA
VG7291ET	1/2	1.8	345	VG7291ET+423AGA	VG7291ET+423BGA	VG7291ET+423GGA
VG7291GT	1/2	4.6	208	VG7291GT+423AGA	VG7291GT+423BGA	VG7291GT+423GGA
Two-Way Push-Down-to-Open — 3/4 in. Union Sweat End Connections						
VG7491CT	1/2	0.73	345	VG7491CT+423AGA	VG7491CT+423BGA	VG7491CT+423GGA
VG7491ET	1/2	1.8	345	VG7491ET+423AGA	VG7491ET+423BGA	VG7491ET+423GGA
VG7491GT	1/2	4.6	173	VG7491GT+423AGA	VG7491GT+423BGA	VG7491GT+423GGA
Three-Way Mixing — 3/4 in. Union Sweat End Connections						
VG7892CT	1/2	0.73	345/345	VG7892CT+423AGA	VG7892CT+423BGA	VG7892CT+423GGA
VG7892ET	1/2	1.8	345/345	VG7892ET+423AGA	VG7892ET+423BGA	VG7892ET+423GGA
VG7892GT	1/2	4.6	208/173	VG7892GT+423AGA	VG7892GT+423BGA	VG7892GT+423GGA

VG7000 Series Brass Trim Globe Valves with VA-4233 Series Spring-Return Electric Actuators (Continued)

VG7000 Series Brass Trim Valve Assemblies with VA-4233 Series Spring-Return Electric Actuators and Two Auxiliary Switches (Part 1 of 2)

Actuator Code Number				VA-4233-AGC-2	VA-4233-BGC-2	VA-4233-GGC-2
Actuator Input				Floating	On/Off	0 VDC to 10 VDC Proportional
Temperature Range				35°F to 250°F (2°C to 121°C), 15 psig Saturated Steam		
Valve Code Number	Size, in.	Cv	Closeoff psig	Spring Return Stem Up		
Two-Way Push-Down-to-Close — NPT End Connections						
VG7241CT	1/2	0.73	345	VG7241CT+423AGC	VG7241CT+423BGC	VG7241CT+423GGC
VG7241ET	1/2	1.8	345	VG7241ET+423AGC	VG7241ET+423BGC	VG7241ET+423GGC
VG7241GT	1/2	4.6	208	VG7241GT+423AGC	VG7241GT+423BGC	VG7241GT+423GGC
VG7241LT	3/4	7.3	132	VG7241LT+423AGC	VG7241LT+423BGC	VG7241LT+423GGC
VG7241NT	1	11.6	63	VG7241NT+423AGC	VG7241NT+423BGC	VG7241NT+423GGC
VG7241PT	1-1/4	18.5	38	VG7241PT+423AGC	VG7241PT+423BGC	VG7241PT+423GGC
Two-Way Push-Down-to-Open — NPT End Connections						
VG7441CT	1/2	0.73	345	VG7441CT+423AGC	VG7441CT+423BGC	VG7441CT+423GGC
VG7441ET	1/2	1.8	345	VG7441ET+423AGC	VG7441ET+423BGC	VG7441ET+423GGC
VG7441GT	1/2	4.6	173	VG7441GT+423AGC	VG7441GT+423BGC	VG7441GT+423GGC
VG7441LT	3/4	7.3	103	VG7441LT+423AGC	VG7441LT+423BGC	VG7441LT+423GGC
VG7441NT	1	11.6	66	VG7441NT+423AGC	VG7441NT+423BGC	VG7441NT+423GGC
VG7441PT	1-1/4	18.5	38	VG7441PT+423AGC	VG7441PT+423BGC	VG7441PT+423GGC
Three-Way Mixing — NPT End Connections						
VG7842CT	1/2	0.73	345/345	VG7842CT+423AGC	VG7842CT+423BGC	VG7842CT+423GGC
VG7842ET	1/2	1.8	345/345	VG7842ET+423AGC	VG7842ET+423BGC	VG7842ET+423GGC
VG7842GT	1/2	4.6	208/173	VG7842GT+423AGC	VG7842GT+423BGC	VG7842GT+423GGC
VG7842LT	3/4	7.3	132/103	VG7842LT+423AGC	VG7842LT+423BGC	VG7842LT+423GGC
VG7842NT	1	11.6	63/66	VG7842NT+423AGC	VG7842NT+423BGC	VG7842NT+423GGC
VG7842PT	1-1/4	18.5	38/38	VG7842PT+423AGC	VG7842PT+423BGC	VG7842PT+423GGC
Two-Way Push-Down-to-Close — Union Sweat End Connections						
VG7281CT	1/2	0.73	345	VG7281CT+423AGC	VG7281CT+423BGC	VG7281CT+423GGC
VG7281ET	1/2	1.8	345	VG7281ET+423AGC	VG7281ET+423BGC	VG7281ET+423GGC
VG7281GT	1/2	4.6	208	VG7281GT+423AGC	VG7281GT+423BGC	VG7281GT+423GGC
VG7281LT	3/4	7.3	132	VG7281LT+423AGC	VG7281LT+423BGC	VG7281LT+423GGC
VG7281NT	1	11.6	63	VG7281NT+423AGC	VG7281NT+423BGC	VG7281NT+423GGC
VG7281PT	1-1/4	18.5	38	VG7281PT+423AGC	VG7281PT+423BGC	VG7281PT+423GGC
Two-Way Push-Down-to-Open — Union Sweat End Connections						
VG7481CT	1/2	0.73	345	VG7481CT+423AGC	VG7481CT+423BGC	VG7481CT+423GGC
VG7481ET	1/2	1.8	345	VG7481ET+423AGC	VG7481ET+423BGC	VG7481ET+423GGC
VG7481GT	1/2	4.6	173	VG7481GT+423AGC	VG7481GT+423BGC	VG7481GT+423GGC
VG7481LT	3/4	7.3	103	VG7481LT+423AGC	VG7481LT+423BGC	VG7481LT+423GGC
VG7481NT	1	11.6	66	VG7481NT+423AGC	VG7481NT+423BGC	VG7481NT+423GGC
VG7481PT	1-1/4	18.5	38	VG7481PT+423AGC	VG7481PT+423BGC	VG7481PT+423GGC
Three-Way Mixing — Union Sweat End Connections						
VG7882CT	1/2	0.73	345/345	VG7882CT+423AGC	VG7882CT+423BGC	VG7882CT+423GGC
VG7882ET	1/2	1.8	345/345	VG7882ET+423AGC	VG7882ET+423BGC	VG7882ET+423GGC
VG7882GT	1/2	4.6	208/173	VG7882GT+423AGC	VG7882GT+423BGC	VG7882GT+423GGC
VG7882LT	3/4	7.3	132/103	VG7882LT+423AGC	VG7882LT+423BGC	VG7882LT+423GGC
VG7882NT	1	11.6	63/66	VG7882NT+423AGC	VG7882NT+423BGC	VG7882NT+423GGC
VG7882PT	1-1/4	18.5	38/38	VG7882PT+423AGC	VG7882PT+423BGC	VG7882PT+423GGC
Two-Way Push-Down-to-Close — 3/8 in. Union Sweat End Connections						
VG7271CT	1/2	0.73	345	VG7271CT+423AGC	VG7271CT+423BGC	VG7271CT+423GGC
VG7271ET	1/2	1.8	345	VG7271ET+423AGC	VG7271ET+423BGC	VG7271ET+423GGC
VG7271GT	1/2	4.6	208	VG7271GT+423AGC	VG7271GT+423BGC	VG7271GT+423GGC
Two-Way Push-Down-to-Open — 3/8 in. Union Sweat End Connections						
VG7471CT	1/2	0.73	345	VG7471CT+423AGC	VG7471CT+423BGC	VG7471CT+423GGC
VG7471ET	1/2	1.8	345	VG7471ET+423AGC	VG7471ET+423BGC	VG7471ET+423GGC
VG7471GT	1/2	4.6	173	VG7471GT+423AGC	VG7471GT+423BGC	VG7471GT+423GGC

The performance specifications are nominal and conform to acceptable industry standards. For applications at conditions beyond these specifications, consult the local Johnson Controls office. Johnson Controls shall not be liable for damages resulting from misapplication or misuse of its products. © 2019 Johnson Controls. www.johnsoncontrols.com

VG7000 Series Brass Trim Globe Valves with VA-4233 Series Spring-Return Electric Actuators (Continued)

VG7000 Series Brass Trim Valve Assemblies with VA-4233 Series Spring-Return Electric Actuators and Two Auxiliary Switches (Part 2 of 2)

Actuator Code Number				VA-4233-AGC-2	VA-4233-BGC-2	VA-4233-GGC-2
Actuator Input				Floating	On/Off	0 VDC to 10 VDC Proportional
Temperature Range				35°F to 250°F (2°C to 121°C), 15 psig Saturated Steam		
Valve Code Number	Size, in.	Cv	Closeoff psig	Spring Return Stem Up		
Three-Way Mixing — 3/8 in. Union Sweat End Connections						
VG7872CT	1/2	0.73	345/345	VG7872CT+423AGC	VG7872CT+423BGC	VG7872CT+423GGC
VG7872ET	1/2	1.8	345/345	VG7872ET+423AGC	VG7872ET+423BGC	VG7872ET+423GGC
VG7872GT	1/2	4.6	208/173	VG7872GT+423AGC	VG7872GT+423BGC	VG7872GT+423GGC
Two-Way Push-Down-to-Close — 3/4 in. Union Sweat End Connections						
VG7291CT	1/2	0.73	345	VG7291CT+423AGC	VG7291CT+423BGC	VG7291CT+423GGC
VG7291ET	1/2	1.8	345	VG7291ET+423AGC	VG7291ET+423BGC	VG7291ET+423GGC
VG7291GT	1/2	4.6	208	VG7291GT+423AGC	VG7291GT+423BGC	VG7291GT+423GGC
Two-Way Push-Down-to-Open — 3/4 in. Union Sweat End Connections						
VG7491CT	1/2	0.73	345	VG7491CT+423AGC	VG7491CT+423BGC	VG7491CT+423GGC
VG7491ET	1/2	1.8	345	VG7491ET+423AGC	VG7491ET+423BGC	VG7491ET+423GGC
VG7491GT	1/2	4.6	173	VG7491GT+423AGC	VG7491GT+423BGC	VG7491GT+423GGC
Three-Way Mixing — 3/4 in. Union Sweat End Connections						
VG7892CT	1/2	0.73	345/345	VG7892CT+423AGC	VG7892CT+423BGC	VG7892CT+423GGC
VG7892ET	1/2	1.8	345/345	VG7892ET+423AGC	VG7892ET+423BGC	VG7892ET+423GGC
VG7892GT	1/2	4.6	208/173	VG7892GT+423AGC	VG7892GT+423BGC	VG7892GT+423GGC

Technical Specifications

VG7000 Series Brass Trim Globe Valves with VA-4233 Series Spring-Return Electric Actuators		
Service ¹	Hot Water, Chilled Water, 50/50 Glycol Solutions, and Steam for HVAC Systems	
Fluid Temperature Limits	Water	35°F to 250°F (2°C to 121°C)
	Steam	15 psig (103 kPa) Saturated Steam
Maximum Allowable Pressure/Temperature	Water	400 psig (2,756 kPa) up to 150°F (66°C) Decreasing to 365 psig (2,515 kPa) at 248°F (120°C)
	Steam	15 psig (103 kPa) Saturated Steam at 250°F (121°C)
Valve Body Pressure/Temperature Rating	Meets Requirements of ANSI B16.15, Class 250	
Maximum Recommended Operating Pressure Drop	Water	35 psig (241 kPa) for 1/2 through 1-1/4 in. Valves
	Steam	15 psig (103 kPa)
Flow Characteristics	Two-Way Valves	Equal Percentage
	Three-Way Valves	Linear Flow Characteristics
Rangeability ²	> 25:1 According to EN60534-2-4 for the 1/2 in. Size, Cv 0.73, Valve Bodies > 100:1 According to EN60534-2-4 for All Other Valves	
Leakage	0.01% of Maximum Flow per ANSI/FCI 70-2, Class 4	
Actuator Ambient Operating Temperature Limits	-4°F to 122°F (-20°C to 50°C)	
Actuator Input Signal	VA-4233-AGx-2	24 VAC or 24 VDC Three-Wire Floating Control
	VA-4233-BGx-2	24 VAC or 24 VDC Two-Wire On/Off Control
	VA-4233-GGx-2	0(2) VDC to 10 VDC Proportional Control, 0 VDC to 10 VDC Feedback
Actuator Power Requirements	24 VAC (20 VAC to 30 VAC), 50/60 Hz, 12 VA Nominal	
Materials	Body	Cast Bronze
	Bonnet	Brass
	Stem	Stainless Steel
	Plug	Brass
	Seat	Brass against Molded Elastomeric Disk
	Packing	Self-Adjusting Ethylene Propylene Rubber (EPR) Ring Pack U-Cups
Compliance	Canada	CRN: 0C1099.9087YTN

1. Refer to the VDI 2035 Guideline for recommended proper water treatment.

2. Rangeability is defined as the ratio of maximum controllable flow to minimum controllable flow.

WARNING: BRASS MAY CONTAIN LEAD

To fulfill our obligations towards Article 33, in accordance to the European REACH Regulation No 1907/2006 EC, we hereby inform you that this article contains the following Substances of Very High Concern mentioned on the Candidate list:

- Lead

VG7000 Series Brass Trim Globe Valves with VA7800 Series Electric Actuators

Description

VG7000 Series Globe Valves are designed to regulate the flow of hot water, chilled water, glycol solutions, and steam in response to the demand of a controller in HVAC systems. Available in sizes 1/2 through 2 in. (DN15 through DN50), this family of two- and three-way bronze valves is available in Normally Open (N.O.), Normally Closed (N.C.), and three-way mixing configurations.

Refer to the *VG7000 Series Bronze Control Valves Product Bulletin (LIT-977140)* for important product application information.

Features

- available in brass and stainless steel trim
- available with spring-return and non-spring-return actuators

- meets requirements of American Society of Mechanical Engineers (ASME) B16.15 class 250
- long life replaceable ring packing provides highest reliability and longest life
- every valve tested for tight shutoff
- optional end switches available
- voltage 24 VAC/VDC, 20 VA transformer sizing

Repair Information

If the VG7000 Series Globe Valve fails to operate within its specifications, replace the valve body, actuator, or entire assembly. For replacement parts, contact the nearest Johnson Controls® representative.



VG7000 Series Valve with VA7820 Actuator

Selection Charts

VG7000 Series Brass Trim Globe Valves with VA7800 Series Non-Spring-Return Electric Actuators

Valve Code Number	Size, in.	Cv	Closeoff psig	Non-Spring Return			
				Without Auxiliary Switches		With Two Auxiliary Switches	
				VA7810-AGA-2 On/Off (Floating)	VA7810-HGA-2 (Proportional)	VA7810-AGC-2 On/Off (Floating)	VA7810-HGC-2 (Proportional)
Two-Way Push-Down-to-Close — NPT End Connections							
VG7241NT	1	11.6	182	VG7241NT+71CAGA	VG7241NT+71CHGA	VG7241NT+71CAGC	VG7241NT+71CHGC
VG7241PT	1-1/4	18.5	111	VG7241PT+71CAGA	VG7241PT+71CHGA	VG7241PT+71CAGC	VG7241PT+71CHGC
VG7241RT	1-1/2	28.9	71	VG7241RT+71CAGA	VG7241RT+71CHGA	VG7241RT+71CAGC	VG7241RT+71CHGC
VG7241ST	2	46.2	46	VG7241ST+71CAGA	VG7241ST+71CHGA	VG7241ST+71CAGC	VG7241ST+71CHGC
Three-Way Mixing — NPT End Connections							
VG7842NT	1	11.6	182/213	VG7842NT+71CAGA	VG7842NT+71CHGA	VG7842NT+71CAGC	VG7842NT+71CHGC
VG7842PT	1-1/4	18.5	111/122	VG7842PT+71CAGA	VG7842PT+71CHGA	VG7842PT+71CAGC	VG7842PT+71CHGC
VG7842RT	1-1/2	28.9	71/76	VG7842RT+71CAGA	VG7842RT+71CHGA	VG7842RT+71CAGC	VG7842RT+71CHGC
VG7842ST	2	46.2	46/47	VG7842ST+71CAGA	VG7842ST+71CHGA	VG7842ST+71CAGC	VG7842ST+71CHGC

VG7000 Series Brass Trim Globe Valves with VA7800 Series Spring-Return Electric Actuators

Valve Code Number	Size, in.	Cv	Closeoff psig	Spring Return			
				Spring Return Stem Up		Spring Return Stem Down	
				VA7820-HGA-2 ¹ Proportional without Switches	VA7820-HGC-2 ¹ Proportional with Two Switches	VA7830-HGA-2 ¹ Proportional without Switches	VA7830-HGC-2 ¹ Proportional with Two Switches
Two-Way Push-Down-to-Close (Normally Open) — NPT End Connections							
VG7241NT	1	11.6	182	VG7241NT+72CHGA	VG7241NT+72CHGC		
VG7241PT	1-1/4	18.5	111	VG7241PT+72CHGA	VG7241PT+72CHGC		
VG7241RT	1-1/2	28.9	71	VG7241RT+72CHGA	VG7241RT+72CHGC		
VG7241ST	2	46.2	46	VG7241ST+72CHGA	VG7241ST+72CHGC		
Two-Way Push-Down-to-Open (Normally Closed) — NPT End Connections							
VG7441NT	1	11.6	213	VG7441NT+72CHGA	VG7441NT+72CHGC		
VG7441PT	1-1/4	18.5	122	VG7441PT+72CHGA	VG7441PT+72CHGC		
VG7441RT	1-1/2	28.9	76	VG7441RT+72CHGA	VG7441RT+72CHGC		
VG7441ST	2	46.2	47	VG7441ST+72CHGA	VG7441ST+72CHGC		
Three-Way Mixing — NPT End Connections							
VG7842NT	1	11.6	182/213	VG7842NT+72CHGA	VG7842NT+72CHGC	VG7842NT+74CHGA	VG7842NT+74CHGC
VG7842PT	1-1/4	18.5	111/122	VG7842PT+72CHGA	VG7842PT+72CHGC	VG7842PT+74CHGA	VG7842PT+74CHGC
VG7842RT	1-1/2	28.9	71/76	VG7842RT+72CHGA	VG7842RT+72CHGC	VG7842RT+74CHGA	VG7842RT+74CHGC
VG7842ST	2	46.2	46/47	VG7842ST+72CHGA	VG7842ST+72CHGC	VG7842ST+74CHGA	VG7842ST+74CHGC

1. VA7820 and VA7830 spring-return actuators are shipped from the factory set up for 0-10 VDC proportional control. These actuators have field-selectable switches that allow the actuators to be used for on/off control, or three-wire floating control.

VG7000 Series Brass Trim Globe Valves with VA7800 Series Electric Actuators (Continued)

Technical Specifications

VG7000 Series Brass Trim Globe Valves with VA7800 Series Electric Actuators ¹		
Service ²		Hot Water, Chilled Water, 50/50 Glycol Solutions, and 38 psig (262 kPa) Saturated Steam for HVAC Systems
Fluid Temperature Limits	Water	35°F to 284°F (2°C to 140°C)
	Steam	38 psig (262 kPa) at 284°F (140°C)
Valve Stroke	5/16 in.	For All 1/2 in. and 3/4 in. Valves
	1/2 in.	For All 1 in. and 1-1/4 in. Valves
	3/4 in.	For All 1-1/2 in. and 2 in. Valves
Valve Body Rating		Meets Requirements of ASME B16.15 Class 250
Valve Assembly Maximum Allowable Pressure/Temperature	Water	400 psig (2,756 kPa) up to 150°F (66°C); Decreasing to 365 psig (2,515 kPa) at 248°F (120°C)
	Steam	35 psig (262 kPa) Saturated Steam at 284°F (140°C)
Maximum Recommended Operating Pressure Drop	35 psi	For 1/2 in. through 1-1/4 in. Valves
	30 psi	For 1-1/2 in. and 2 in. Valves
Flow Characteristics	Two-Way	Equal Percentage
	Three-Way	Linear
Rangeability ³		> 100:1 According to EN60534-2-4
Actuator Ambient Operating Temperature Limits	VA7800 Series	23°F to 131°F (-5°C to 55°C)
Leakage		0.01% of Maximum Flow per ANSI/FCI 70-2, Class 4
End Connections	NPT	Factory or Field Assembly
	Sweat	Field Assembly Only
	Union Globe	Field Assembly Only
	Union Angle	Field Assembly Only
Materials	Body	Cast Bronze
	Bonnet	Brass
	Stem	300 Series Stainless Steel
	Plug	Brass
	Seat	Brass against Molded Elastomeric Disk
	Packing	Self-Adjusting Ethylene Propylene Rubber (EPR) Ring Pack U-Cups
Compliance	Canada	CRN: 0C1099.9087YTN

1. In steam applications, install the valve with the stem horizontal to the piping, and wrap the valve and piping with insulation.
2. Proper water treatment is recommended; refer to the VDI 2035 Guideline.
3. Rangeability is defined as the ratio of maximum controllable flow to minimum controllable flow.



WARNING This product is made of copper alloy, which contains lead. The product is therefore not to be used on drinking water.



WARNING This product can expose you to chemicals including lead, which is known to the State of California to cause cancer, birth defects, or other reproductive harm. For more information, go to www.P65Warnings.ca.gov.

WARNING: BRASS MAY CONTAIN LEAD

To fulfill our obligations towards Article 33, in accordance to the European REACH Regulation No 1907/2006 EC, we hereby inform you that this article contains the following Substances of Very High Concern mentioned on the Candidate list:

- Lead

VG7000 Series Stainless Steel Trim Globe Valves with VA-715x Series Electric Actuators

Description

VG7000 Series Stainless Steel Trim Globe Valves with VA-715x Series Pneumatic Actuators control hot or chilled water, or steam.

Refer to the *VG7000 Series Bronze Control Valves Product Bulletin (LIT-977140)* for important product application information.

Features

- 90 lb force provides tight closeoff
- direct coupled; no linkage required
- packing: spring-loaded PTFE and elastomer V-rings
- magnetic clutch protects gearing, ensures tight closeoff
- controls hot water, chilled water, or steam

- fits VG7000 Series valves 1/2 through 2 in.
- valve body static pressure rating: ANSI Class 250
- factory or field assembly
- voltage: 24 VAC, 50/60 Hz, 4.7 VA

Repair Information

If the VG7000 Series Globe Valve fails to operate within its specifications, replace the valve body, actuator, or entire assembly. For replacement parts, contact the nearest Johnson Controls® representative.

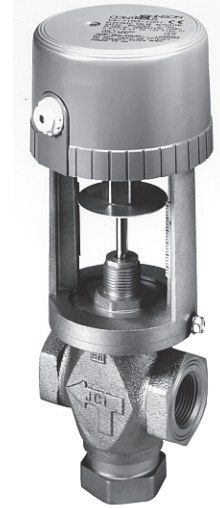

VA-715x Series Electric Actuator Mounted on VG7844 Brass Globe Valve

Selection Chart

Actuator Code Number				VA-7150-1001	VA-7153-1001	VA-7152-1001
Actuator Input				On/Off (Floating)	On/Off (Floating) with Feedback	0 VDC to 10 VDC Proportional
Temperature Range				35°F to 338°F Fluid Temperature, 100 psig Saturated Steam		
Valve Code Number	Size, in.	Cv	Closeoff psig	Non-Spring Return		
Two-Way Push-Down-to-Close — NPT End Connections						
VG7243CT	1/2	0.73	239	VG7243CT+7150G	VG7243CT+7153G	VG7243CT+7152G
VG7243ET	1/2	1.8	239	VG7243ET+7150G	VG7243ET+7153G	VG7243ET+7152G
VG7243GT	1/2	4.6	135	VG7243GT+7150G	VG7243GT+7153G	VG7243GT+7152G
VG7243LT	3/4	7.3	86	VG7243LT+7150G	VG7243LT+7153G	VG7243LT+7152G
VG7243NT	1	11.6	54	VG7243NT+7150G	VG7243NT+7153G	VG7243NT+7152G
VG7243PT	1-1/4	18.5	33	VG7243PT+7150G	VG7243PT+7153G	VG7243PT+7152G
VG7243RT	1-1/2	28.9	21	VG7243RT+7150G	VG7243RT+7153G	VG7243RT+7152G
VG7243ST	2	46.2	13	VG7243ST+7150G	VG7243ST+7153G	VG7243ST+7152G
Three-Way Mixing — NPT End Connections						
VG7844CT	1/2	0.73	239/308	VG7844CT+7150G	VG7844CT+7153G	VG7844CT+7152G
VG7844ET	1/2	1.8	239/308	VG7844ET+7150G	VG7844ET+7153G	VG7844ET+7152G
VG7844GT	1/2	4.6	135/161	VG7844GT+7150G	VG7844GT+7153G	VG7844GT+7152G
VG7844LT	3/4	7.3	86/96	VG7844LT+7150G	VG7844LT+7153G	VG7844LT+7152G
VG7844NT	1	11.6	54/63	VG7844NT+7150G	VG7844NT+7153G	VG7844NT+7152G
VG7844PT	1-1/4	18.5	33/36	VG7844PT+7150G	VG7844PT+7153G	VG7844PT+7152G
VG7844RT	1-1/2	28.9	21/22	VG7844RT+7150G	VG7844RT+7153G	VG7844RT+7152G
VG7844ST	2	46.2	13/14	VG7844ST+7150G	VG7844ST+7153G	VG7844ST+7152G

WARNING This product is made of copper alloy, which contains lead. The product is therefore not to be used on drinking water.

WARNING This product can expose you to chemicals including lead, which is known to the State of California to cause cancer, birth defects, or other reproductive harm. For more information, go to www.P65Warnings.ca.gov.

WARNING: BRASS MAY CONTAIN LEAD
 To fulfill our obligations towards Article 33, in accordance to the European REACH Regulation No 1907/2006 EC, we hereby inform you that this article contains the following Substances of Very High Concern mentioned on the Candidate list:

- Lead

VG7000 Series Stainless Steel Trim Globe Valves with VA-715x Series Electric Actuators (Continued)

Technical Specifications

VG7000 Series Stainless Steel Trim Globe Valves with VA-715x Series Electric Actuators		
Service¹		Hot Water, Chilled Water, 50/50 Glycol Solutions, and Steam for HVAC Systems
Fluid Temperature Limits	Water	35°F to 338°F (2°C to 170°C)
	Steam	100 psig (690 kPa) Saturated Steam
Maximum Allowable Pressure/Temperature	Water	400 psig (2,756 kPa) up to 150°F (66°C) Decreasing to 308 psig (2,122 kPa) at 338°F (170°C)
	Steam	100 psig (690 kPa) Saturated Steam
Valve Body Pressure/Temperature Rating		Meets Requirements of ANSI B16.15, Class 250
Maximum Recommended Operating Pressure Drop	Water	35 psig (241 kPa) for 1/2 in. through 1-1/4 in. Valves 30 psig (207 kPa) for 1-1/2 in. and 2 in. Valves
	Steam	100 psig (690 kPa)
Flow Characteristics	Two-Way Valves	Equal Percentage
	Three-Way Valves	Linear Flow Characteristics
Rangeability²		> 25:1 According to EN60534-2-4 for the 1/2 in. Size, Cv 0.73, Valve Bodies > 100:1 According to EN60534-2-4 for All Other Valves
Leakage		0.05% of Maximum Flow per ANSI/FCI 70-2, Class 4
Actuator Ambient Operating Temperature Limits		0°F to 140°F (-18°C to 60°C)
Actuator Input Signal	VA-7150-1001	24 VAC Three-Wire Floating Control
	VA-7152-1001	0 VDC to 10 VDC Proportional Control
	VA-7153-1001	24 VAC Three-Wire Floating Control with 0 to 2,000 Ohm Feedback Potentiometer for 25/32 in. Valve Stroke
Actuator Power Requirements	VA-7150-1001	24 VAC (20 to 30 VAC), 50/60 Hz, 2.7 VA Nominal
	VA-7152-1001	24 VAC (20 to 30 VAC), 50/60 Hz, 4.7 VA Nominal
	VA-7153-1001	24 VAC (20 to 30 VAC), 50/60 Hz, 2.7 VA Nominal
Materials	Body	Cast Bronze
	Bonnet	Brass
	Stem	Stainless Steel
	Plug	Stainless Steel
	Seat	Stainless Steel
	Packing	Spring-Loaded PTFE and Elastomer V-Rings
Compliance	Canada	CRN: 0C1099.9087YTN

1. Refer to the VDI 2035 Guideline for recommended proper water treatment.

2. Rangeability is defined as the ratio of maximum controllable flow to minimum controllable flow.

VG7000 Series Stainless Steel Trim Globe Valves with VA-4233 Series Spring-Return Electric Actuators

Description

VG7000 Series Stainless Steel Trim Globe Valves with VA-4233 Series Spring-Return Electric Actuators control hot or chilled water, or steam.

Refer to the *VG7000 Series Bronze Control Valves Product Bulletin (LIT-977140)* for important product application information.

Features

- spring return stem up
- 61 lb force provides tight shutoff
- packing spring-loaded PTFE and elastomer V-rings
- manual opener

- fits VG7000 Series valves 1/2 through 1-1/4 in.
- valve body static pressure rating: ANSI Class 250
- optional auxiliary switches available
- factory or field assembly
- voltage: 20 VAC to 30 VAC, 50/60 Hz, 12 VA

Repair Information

If the VG7000 Series Globe Valve fails to operate within its specifications, replace the valve body, actuator, or entire assembly. For replacement parts, contact the nearest Johnson Controls® representative.

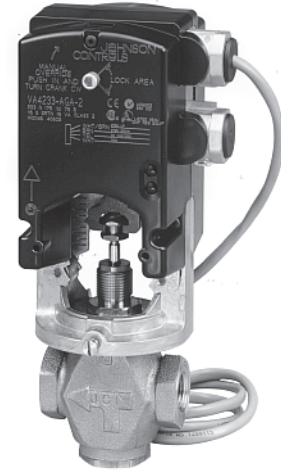

**VA-4233 Electric Actuator
Mounted on a VG7441 Brass Globe Valve**

WARNING

This product is made of copper alloy, which contains lead. The product is therefore not to be used on drinking water.

WARNING

This product can expose you to chemicals including lead, which is known to the State of California to cause cancer, birth defects, or other reproductive harm. For more information, go to www.P65Warnings.ca.gov.

Selection Charts

VG7000 Series Valve Assemblies with VA-4233 Series Spring-Return Electric Actuators, Less Auxiliary Switches

Actuator Code Number				VA-4233-AGA-2	VA-4233-BGA-2	VA-4233-GGA-2
Actuator Input				Floating	On/Off	0 VDC to 10 VDC Proportional
Temperature Range				35°F to 250°F (2°C to 121°C), 15 psig Saturated Steam		
Valve Code Number	Size, in.	Cv	Closeoff psig	Spring Return Stem Up		
Two-Way Push-Down-to-Close — NPT End Connections						
VG7243CT	1/2	0.73	230	VG7243CT+423AGA	VG7243CT+423BGA	VG7243CT+423GGA
VG7243ET	1/2	1.8	230	VG7243ET+423AGA	VG7243ET+423BGA	VG7243ET+423GGA
VG7243GT	1/2	4.6	130	VG7243GT+423AGA	VG7243GT+423BGA	VG7243GT+423GGA
VG7243LT	3/4	7.3	82	VG7243LT+423AGA	VG7243LT+423BGA	VG7243LT+423GGA
VG7243NT	1	11.6	39	VG7243NT+423AGA	VG7243NT+423BGA	VG7243NT+423GGA
VG7243PT	1-1/4	18.5	24	VG7243PT+423AGA	VG7243PT+423BGA	VG7243PT+423GGA
Two-Way Push-Down-to-Open — NPT End Connections						
VG7443CT	1/2	0.73	224	VG7443CT+423AGA	VG7443CT+423BGA	VG7443CT+423GGA
VG7443ET	1/2	1.8	224	VG7443ET+423AGA	VG7443ET+423BGA	VG7443ET+423GGA
VG7443GT	1/2	4.6	108	VG7443GT+423AGA	VG7443GT+423BGA	VG7443GT+423GGA
VG7443LT	3/4	7.3	64	VG7443LT+423AGA	VG7443LT+423BGA	VG7443LT+423GGA
VG7443NT	1	11.6	41	VG7443NT+423AGA	VG7443NT+423BGA	VG7443NT+423GGA
VG7443PT	1-1/4	18.5	24	VG7443PT+423AGA	VG7443PT+423BGA	VG7443PT+423GGA
Three-Way Mixing — NPT End Connections						
VG7844CT	1/2	0.73	230/224	VG7844CT+423AGA	VG7844CT+423BGA	VG7844CT+423GGA
VG7844ET	1/2	1.8	230/224	VG7844ET+423AGA	VG7844ET+423BGA	VG7844ET+423GGA
VG7844GT	1/2	4.6	130/108	VG7844GT+423AGA	VG7844GT+423BGA	VG7844GT+423GGA
VG7844LT	3/4	7.3	82/64	VG7844LT+423AGA	VG7844LT+423BGA	VG7844LT+423GGA
VG7844NT	1	11.6	39/41	VG7844NT+423AGA	VG7844NT+423BGA	VG7844NT+423GGA
VG7844PT	1-1/4	18.5	24/24	VG7844PT+423AGA	VG7844PT+423BGA	VG7844PT+423GGA

WARNING: BRASS MAY CONTAIN LEAD

To fulfill our obligations towards Article 33, in accordance to the European REACH Regulation No 1907/2006 EC, we hereby inform you that this article contains the following Substances of Very High Concern mentioned on the Candidate list:

- Lead

VG7000 Series Stainless Steel Trim Globe Valves with VA-4233 Series Spring-Return Electric Actuators (Continued)

VG7000 Series Valve Assemblies with VA-4233 Series Spring-Return Electric Actuators and Two Auxiliary Switches

Actuator Code Number				VA-4233-AGC-2	VA-4233-BGC-2	VA-4233-GGC-2
Actuator Input				Floating	On/Off	0 VDC to 10 VDC Proportional
Temperature Range				35°F to 250°F (2°C to 121°C), 15 psig Saturated Steam		
Valve Code Number	Size, in.	Cv	Closeoff psig	Spring Return Stem Up		
Two-Way Push-Down-to-Close — NPT End Connections						
VG7243CT	1/2	0.73	230	VG7243CT+423AGC	VG7243CT+423BGC	VG7243CT+423GGC
VG7243ET	1/2	1.8	230	VG7243ET+423AGC	VG7243ET+423BGC	VG7243ET+423GGC
VG7243GT	1/2	4.6	130	VG7243GT+423AGC	VG7243GT+423BGC	VG7243GT+423GGC
VG7243LT	3/4	7.3	82	VG7243LT+423AGC	VG7243LT+423BGC	VG7243LT+423GGC
VG7243NT	1	11.6	39	VG7243NT+423AGC	VG7243NT+423BGC	VG7243NT+423GGC
VG7243PT	1-1/4	18.5	24	VG7243PT+423AGC	VG7243PT+423BGC	VG7243PT+423GGC
Two-Way Push-Down-to-Open — NPT End Connections						
VG7443CT	1/2	0.73	224	VG7443CT+423AGC	VG7443CT+423BGC	VG7443CT+423GGC
VG7443ET	1/2	1.8	224	VG7443ET+423AGC	VG7443ET+423BGC	VG7443ET+423GGC
VG7443GT	1/2	4.6	108	VG7443GT+423AGC	VG7443GT+423BGC	VG7443GT+423GGC
VG7443LT	3/4	7.3	64	VG7443LT+423AGC	VG7443LT+423BGC	VG7443LT+423GGC
VG7443NT	1	11.6	41	VG7443NT+423AGC	VG7443NT+423BGC	VG7443NT+423GGC
VG7443PT	1-1/4	18.5	24	VG7443PT+423AGC	VG7443PT+423BGC	VG7443PT+423GGC
Three-Way Mixing — NPT End Connections						
VG7844CT	1/2	0.73	230/224	VG7844CT+423AGC	VG7844CT+423BGC	VG7844CT+423GGC
VG7844ET	1/2	1.8	230/224	VG7844ET+423AGC	VG7844ET+423BGC	VG7844ET+423GGC
VG7844GT	1/2	4.6	130/108	VG7844GT+423AGC	VG7844GT+423BGC	VG7844GT+423GGC
VG7844LT	3/4	7.3	82/64	VG7844LT+423AGC	VG7844LT+423BGC	VG7844LT+423GGC
VG7844NT	1	11.6	39/41	VG7844NT+423AGC	VG7844NT+423BGC	VG7844NT+423GGC
VG7844PT	1-1/4	18.5	24/24	VG7844PT+423AGC	VG7844PT+423BGC	VG7844PT+423GGC

Technical Specifications

VG7000 Series Stainless Steel Trim Globe Valves with VA-4233 Series Spring-Return Electric Actuators		
Service ¹	Hot Water, Chilled Water, 50/50 Glycol Solutions, and Steam for HVAC Systems	
Fluid Temperature Limits	Water	35°F to 250°F (2°C to 121°C)
	Steam	15 psig (103 kPa) Saturated Steam
Maximum Allowable Pressure/Temperature	Water	400 psig (2,756 kPa) up to 150°F (66°C) Decreasing to 365 psig (2,515 kPa) at 248°F (120°C)
	Steam	15 psig (103 kPa) Saturated Steam at 250°F (121°C)
Valve Body Pressure/Temperature Rating	Meets Requirements of ANSI B16.15, Class 250	
Maximum Recommended Operating Pressure Drop	Water	35 psig (241 kPa) for 1/2 in. through 1-1/4 in. Valves
	Steam	15 psig (103 kPa)
Flow Characteristics	Two-Way Valves	Equal Percentage
	Three-Way Valves	Linear Flow Characteristics
Rangeability ²	> 25:1 According to EN60534-2-4 for the 1/2 in. Size, Cv 0.73, Valve Bodies > 100:1 According to EN60534-2-4 for All Other Valves	
Leakage	0.01% of Maximum Flow per ANSI/FCI 70-2, Class 4	
Actuator Ambient Operating Temperature Limits	-4°F to 122°F (-20°C to 50°C)	
Actuator Input Signal	VA-4233-AGx-2	24 VAC or 24 VDC Three-Wire Floating Control
	VA-4233-BGx-2	24 VAC or 24 VDC Two-Wire On/Off Control
	VA-4233-GGx-2	0(2) VDC to 10 VDC Proportional Control, 0 VDC to 10 VDC Feedback
Actuator Power Requirements	24 VAC (20 VAC to 30 VAC), 50/60 Hz, 12 VA Nominal	
Materials	Body	Cast Bronze
	Bonnet	Brass
	Stem	Stainless Steel
	Plug	Brass
	Seat	Brass against Molded Elastomeric Disk
	Packing	Self-Adjusting Ethylene Propylene Rubber (EPR) Ring Pack U-Cups
Compliance	Canada	CRN: 0C1099.9087YTN

1. Refer to the VDI 2035 Guideline for recommended proper water treatment.

2. Rangeability is defined as the ratio of maximum controllable flow to minimum controllable flow.

The performance specifications are nominal and conform to acceptable industry standards. For applications at conditions beyond these specifications, consult the local Johnson Controls office. Johnson Controls shall not be liable for damages resulting from misapplication or misuse of its products. © 2019 Johnson Controls. www.johnsoncontrols.com

VG7000 Series Stainless Steel Trim Globe Valves with VA7800 Series Electric Actuators

Description

VG7000 Series Globe Valves are designed to regulate the flow of hot water, chilled water, glycol solutions, and steam in response to the demand of a controller in HVAC systems. Available in sizes 1/2 through 2 in. (DN15 through DN50), this family of two- and three-way bronze valves is available in Normally Open (N.O.), Normally Closed (N.C.), and three-mixing configurations.

Refer to the *VG7000 Series Bronze Control Valves Product Bulletin (LIT-977140)* for important product application information.

Features

- available in brass and stainless steel trim
- available with spring-return and non-spring-return actuators

- meets requirements of American Society of Mechanical Engineers (ASME) B16.15 class 250
- long life replaceable ring packing provides highest reliability and longest life
- every valve tested for tight shutoff
- optional end switches available
- voltage 24 VAC/VDC, 20 VA transformer sizing

Repair Information

If the VG7000 Series Globe Valve fails to operate within its specifications, replace the valve body, actuator, or entire assembly. For replacement parts, contact the nearest Johnson Controls® representative.



VG7000 Series Valve with VA7820 Actuator

Selection Charts

Stainless Steel Trim Globe Valves with VA7800 Series Non-Spring-Return Electric Actuators

Valve Code Number	Size, in.	Cv	Closeoff psig	Non-Spring Return			
				Without Auxiliary Switches		With Two Auxiliary Switches	
				VA7810-AGA-2 On/Off (Floating)	VA7810-HGA-2 (Proportional)	VA7810-AGC-2 On/Off (Floating)	VA7810-HGC-2 (Proportional)
Two-Way Push-Down-to-Close — NPT End Connections							
VG7243CT	1/2	0.73	308	VG7243CT+71CAGA	VG7243CT+71CHGA	VG7243CT+71CAGC	VG7243CT+71CHGC
VG7243ET	1/2	1.8	308	VG7243ET+71CAGA	VG7243ET+71CHGA	VG7243ET+71CAGC	VG7243ET+71CHGC
VG7243GT	1/2	4.6	278	VG7243GT+71CAGA	VG7243GT+71CHGA	VG7243GT+71CAGC	VG7243GT+71CHGC
VG7243LT	3/4	7.3	177	VG7243LT+71CAGA	VG7243LT+71CHGA	VG7243LT+71CAGC	VG7243LT+71CHGC
VG7243NT	1	11.6	112	VG7243NT+71CAGA	VG7243NT+71CHGA	VG7243NT+71CAGC	VG7243NT+71CHGC
VG7243PT	1-1/4	18.5	68	VG7243PT+71CAGA	VG7243PT+71CHGA	VG7243PT+71CAGC	VG7243PT+71CHGC
VG7243RT	1-1/2	28.9	44	VG7243RT+71CAGA	VG7243RT+71CHGA	VG7243RT+71CAGC	VG7243RT+71CHGC
VG7243ST	2	46.2	28	VG7243ST+71CAGA	VG7243ST+71CHGA	VG7243ST+71CAGC	VG7243ST+71CHGC
Three-Way Mixing — NPT End Connections							
VG7844CT	1/2	0.73	308/308	VG7844CT+71CAGA	VG7844CT+71CHGA	VG7844CT+71CAGC	VG7844CT+71CHGC
VG7844ET	1/2	1.8	308/308	VG7844ET+71CAGA	VG7844ET+71CHGA	VG7844ET+71CAGC	VG7844ET+71CHGC
VG7844GT	1/2	4.6	278/308	VG7844GT+71CAGA	VG7844GT+71CHGA	VG7844GT+71CAGC	VG7844GT+71CHGC
VG7844LT	3/4	7.3	177/197	VG7844LT+71CAGA	VG7844LT+71CHGA	VG7844LT+71CAGC	VG7844LT+71CHGC
VG7844NT	1	11.6	112/131	VG7844NT+71CAGA	VG7844NT+71CHGA	VG7844NT+71CAGC	VG7844NT+71CHGC
VG7844PT	1-1/4	18.5	68/75	VG7844PT+71CAGA	VG7844PT+71CHGA	VG7844PT+71CAGC	VG7844PT+71CHGC
VG7844RT	1-1/2	28.9	44/46	VG7844RT+71CAGA	VG7844RT+71CHGA	VG7844RT+71CAGC	VG7844RT+71CHGC
VG7844ST	2	46.2	28/29	VG7844ST+71CAGA	VG7844ST+71CHGA	VG7844ST+71CAGC	VG7844ST+71CHGC

Stainless Steel Trim Globe Valves with VA7800 Series Spring-Return Electric Actuators (Part 1 of 2)

Valve Code Number	Size, in.	Cv	Closeoff psig	Spring Return			
				Spring Return Stem Up		Spring Return Stem Down	
				VA7820-HGA-2 ¹ Proportional without Switches	VA7820-HGC-2 ¹ Proportional with Two Switches	VA7830-HGA-2 ¹ Proportional without Switches	VA7830-HGC-2 ¹ Proportional with Two Switches
Two-Way Push-Down-to-Close (Normally Open) — NPT End Connections							
VG7243CT	1/2	0.73	308	VG7243CT+72CHGA	VG7243CT+72CHGC		
VG7243ET	1/2	1.8	308	VG7243ET+72CHGA	VG7243ET+72CHGC		
VG7243GT	1/2	4.6	278	VG7243GT+72CHGA	VG7243GT+72CHGC		
VG7243LT	3/4	7.3	177	VG7243LT+72CHGA	VG7243LT+72CHGC		
VG7243NT	1	11.6	112	VG7243NT+72CHGA	VG7243NT+72CHGC		
VG7243PT	1-1/4	18.5	68	VG7243PT+72CHGA	VG7243PT+72CHGC		
VG7243RT	1-1/2	28.9	44	VG7243RT+72CHGA	VG7243RT+72CHGC		
VG7243ST	2	46.2	28	VG7243ST+72CHGA	VG7243ST+72CHGC		

The performance specifications are nominal and conform to acceptable industry standards. For applications at conditions beyond these specifications, consult the local Johnson Controls office. Johnson Controls shall not be liable for damages resulting from misapplication or misuse of its products. © 2019 Johnson Controls. www.johnsoncontrols.com

VG7000 Series Stainless Steel Trim Globe Valves with VA7800 Series Electric Actuators (Continued)

Stainless Steel Trim Globe Valves with VA7800 Series Spring-Return Electric Actuators (Part 2 of 2)

Valve Code Number	Size, in.	Cv	Closeoff psig	Spring Return			
				Spring Return Stem Up		Spring Return Stem Down	
				VA7820-HGA-2 ¹ Proportional without Switches	VA7820-HGC-2 ¹ Proportional with Two Switches	VA7830-HGA-2 ¹ Proportional without Switches	VA7830-HGC-2 ¹ Proportional with Two Switches
Two-Way Push-Down-to-Open (Normally Closed) — NPT End Connections							
VG7443CT	1/2	0.73	308	VG7443CT+72CHGA	VG7443CT+72CHGC		
VG7443ET	1/2	1.8	308	VG7443ET+72CHGA	VG7443ET+72CHGC		
VG7443GT	1/2	4.6	308	VG7443GT+72CHGA	VG7443GT+72CHGC		
VG7443LT	3/4	7.3	197	VG7443LT+72CHGA	VG7443LT+72CHGC		
VG7443NT	1	11.6	131	VG7443NT+72CHGA	VG7443NT+72CHGC		
VG7443PT	1-1/4	18.5	75	VG7443PT+72CHGA	VG7443PT+72CHGC		
VG7443RT	1-1/2	28.9	46	VG7443RT+72CHGA	VG7443RT+72CHGC		
VG7443ST	2	46.2	29	VG7443ST+72CHGA	VG7443ST+72CHGC		
Three-Way Mixing — NPT End Connections							
VG7844CT	1/2	0.73	308/308	VG7844CT+72CHGA	VG7844CT+72CHGC	VG7844CT+74CHGA	VG7844CT+74CHGC
VG7844ET	1/2	1.8	308/308	VG7844ET+72CHGA	VG7844ET+72CHGC	VG7844ET+74CHGA	VG7844ET+74CHGC
VG7844GT	1/2	4.6	278/308	VG7844GT+72CHGA	VG7844GT+72CHGC	VG7844GT+74CHGA	VG7844GT+74CHGC
VG7844LT	3/4	7.3	177/197	VG7844LT+72CHGA	VG7844LT+72CHGC	VG7844LT+74CHGA	VG7844LT+74CHGC
VG7844NT	1	11.6	112/131	VG7844NT+72CHGA	VG7844NT+72CHGC	VG7844NT+74CHGA	VG7844NT+74CHGC
VG7844PT	1-1/4	18.5	68/75	VG7844PT+72CHGA	VG7844PT+72CHGC	VG7844PT+74CHGA	VG7844PT+74CHGC
VG7844RT	1-1/2	28.9	44/46	VG7844RT+72CHGA	VG7844RT+72CHGC	VG7844RT+74CHGA	VG7844RT+74CHGC
VG7844ST	2	46.2	28/29	VG7844ST+72CHGA	VG7844ST+72CHGC	VG7844ST+74CHGA	VG7844ST+74CHGC

1. VA7820 and VA7830 spring-return actuators are shipped from the factory set for 0-10 VDC proportional control. These actuators have field-selectable switches that allow the actuators to be used for on/off control, or three-wire floating control.

Technical Specifications

VG7000 Series Stainless Steel Trim Globe Valves with VA7800 Series Electric Actuators ¹		
Service ²	Hot Water, Chilled Water, 50/50 Glycol Solutions, and 38 psig (262 kPa) Saturated Steam for HVAC Systems	
Fluid Temperature Limits	Water	35°F to 338°F (2°C to 170°C)
	Steam	100 psig (690 kPa) at 338°F (170°C)
Valve Stroke	5/16 in.	For All 1/2 in. and 3/4 in. Valves
	1/2 in.	For All 1 in. and 1-1/4 in. Valves
	3/4 in.	For All 1-1/2 in. and 2 in. Valves
Valve Body Rating	Meets Requirements of ASME B16.15 Class 250	
Valve Assembly Maximum Allowable Pressure/Temperature	Water	400 psig (2,756 kPa) up to 150°F (66°C) Decreasing to 308 psig (2,122 kPa) at 338°F (170°C)
	Steam	100 psig (690 kPa) Saturated Steam at 338°F (170°C)
Maximum Recommended Operating Pressure Drop	35 psi	For 1/2 in. through 1-1/4 in. Valves
	30 psi	For 1-1/2 in. and 2 in. Valves
Flow Characteristics	Two-Way	Equal Percentage
	Three-Way	Linear
Rangeability ³	> 25:1 According to EN60534-2-4 for the 1/2 in. Size, Cv 0.73, Valve Bodies 100:1 According to EN60534-2-4 for All Other Valves	
Actuator Ambient Operating Temperature Limits	VA7800 Series	23°F to 131°F (-5°C to 55°C)
Leakage	0.05% of Maximum Flow	
End Connections	NPT	Factory or Field Assembly
Materials	Body	Cast Bronze
	Bonnet	Brass
	Stem	300 Series Stainless Steel
	Plug	300 Series Stainless Steel
	Seat	300 Series Stainless Steel
	Packing	Spring-Loaded Polytetrafluoroethylene (PTFE) and Elastomer V-Rings
Compliance	Canada	CRN: 0C1099.9087YTN

- In steam applications, install the valve with the stem horizontal to the piping and wrap the valve and piping with insulation.
- Proper water treatment is recommended; refer to the VDI 2035 Guideline.
- Rangeability is defined as the ratio of maximum controllable flow to minimum controllable flow.

The performance specifications are nominal and conform to acceptable industry standards. For applications at conditions beyond these specifications, consult the local Johnson Controls office. Johnson Controls shall not be liable for damages resulting from misapplication or misuse of its products. © 2019 Johnson Controls. www.johnsoncontrols.com

WARNING

This product can expose you to chemicals including lead, which is known to the State of California to cause cancer, birth defects, or other reproductive harm. For more information, go to www.P65Warnings.ca.gov.

WARNING

This product is made of copper alloy, which contains lead. The product is therefore not to be used on drinking water.

WARNING: BRASS MAY CONTAIN LEAD

To fulfill our obligations towards Article 33, in accordance to the European REACH Regulation No 1907/2006 EC, we hereby inform you that this article contains the following Substances of Very High Concern mentioned on the Candidate list:

- Lead

VG7000 Series Brass Trim Globe Valves with V-3801 Compact Pneumatic Actuators

Description

VG7000 Series Brass Trim Globe Valves with V-3801 Compact Pneumatic Actuators control hot or chilled water or 15 psig saturated steam.

Refer to the *VG7000 Series Bronze Control Valves Product Bulletin (LIT-977140)* for important product application information.

Features

- compact; fits in tight spaces such as baseboard radiators and convectors
- rugged actuator die-cast enclosure, enclosed spring
- effective diaphragm area: 4 sq. in.
- controls: hot or chilled water, 15 psig saturated steam

- valve trim: brass
- valve stem: stainless steel
- maximum supply air pressure: 25 psig (172 kPa)
- fluid temperature: 35°F to 248°F (2°C to 120°C)
- valve body static pressure rating: ANSI Class 250
- factory or field assembly

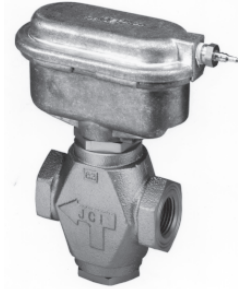

V-3801-8001 Pneumatic Actuator Mounted on VG7842 Brass Globe Valve

Repair Information

If the VG7000 Series Globe Valve fails to operate within its specifications, replace the valve body, actuator, or entire assembly. For replacement parts, contact the nearest Johnson Controls® representative.

Selection Chart

Actuator Code Number			V-3801-8001					
Mounting Kit			VG7000-1010		VG7000-1011		VG7000-1012	
Spring Range			3 psig to 6 psig		4 psig to 8 psig		9 psig to 13 psig	
Valve Code Number	Size, in.	Cv	Closeoff psig	Code Number	Closeoff psig	Code Number	Closeoff psig	Code Number
Two-Way Normally Open — NPT End Connections								
VG7241CS	1/2	0.73	186	VG7241CS+3801B	157	VG7241CS+3801D	84	VG7241CS+3801E
VG7241ES	1/2	1.8	186	VG7241ES+3801B	157	VG7241ES+3801D	84	VG7241ES+3801E
VG7241GS	1/2	4.6	105	VG7241GS+3801B	89	VG7241GS+3801D	48	VG7241GS+3801E
VG7241LS	3/4	7.3	67	VG7241LS+3801B	56	VG7241LS+3801D	30	VG7241LS+3801E
Two-Way Normally Closed — NPT End Connections								
VG7441CS	1/2	0.73	37	VG7441CS+3801B	57	VG7441CS+3801D	158	VG7441CS+3801E
VG7441ES	1/2	1.8	37	VG7441ES+3801B	57	VG7441ES+3801D	158	VG7441ES+3801E
VG7441GS	1/2	4.6	18	VG7441GS+3801B	28	VG7441GS+3801D	76	VG7441GS+3801E
VG7441LS	3/4	7.3	11	VG7441LS+3801B	16	VG7441LS+3801D	45	VG7441LS+3801E
Three-Way Mixing — NPT End Connections								
VG7842CS	1/2	0.73	186/37	VG7842CS+3801B	157/57	VG7842CS+3801D	84/158	VG7842CS+3801E
VG7842ES	1/2	1.8	186/37	VG7842ES+3801B	157/57	VG7842ES+3801D	84/158	VG7842ES+3801E
VG7842GS	1/2	4.6	105/18	VG7842GS+3801B	89/28	VG7842GS+3801D	48/76	VG7842GS+3801E
VG7842LS	3/4	7.3	67/11	VG7842LS+3801B	56/16	VG7842LS+3801D	30/45	VG7842LS+3801E
Two-Way Normally Open — Union Sweat End Connections								
VG7281CS	1/2	0.73	186	VG7281CS+3801B	157	VG7281CS+3801D	84	VG7281CS+3801E
VG7281ES	1/2	1.8	186	VG7281ES+3801B	157	VG7281ES+3801D	84	VG7281ES+3801E
VG7281GS	1/2	4.6	105	VG7281GS+3801B	89	VG7281GS+3801D	48	VG7281GS+3801E
VG7281LS	3/4	7.3	67	VG7281LS+3801B	56	VG7281LS+3801D	30	VG7281LS+3801E
Two-Way Normally Closed — Union Sweat End Connections								
VG7481CS	1/2	0.73	37	VG7481CS+3801B	57	VG7481CS+3801D	158	VG7481CS+3801E
VG7481ES	1/2	1.8	37	VG7481ES+3801B	57	VG7481ES+3801D	158	VG7481ES+3801E
VG7481GS	1/2	4.6	18	VG7481GS+3801B	28	VG7481GS+3801D	76	VG7481GS+3801E
VG7481LS	3/4	7.3	11	VG7481LS+3801B	16	VG7481LS+3801D	45	VG7481LS+3801E
Three-Way Mixing — Union Sweat End Connections								
VG7882CS	1/2	0.73	186/37	VG7882CS+3801B	157/57	VG7882CS+3801D	84/158	VG7882CS+3801E
VG7882ES	1/2	1.8	186/37	VG7882ES+3801B	157/57	VG7882ES+3801D	84/158	VG7882ES+3801E
VG7882GS	1/2	4.6	105/18	VG7882GS+3801B	89/28	VG7882GS+3801D	48/76	VG7882GS+3801E
VG7882LS	3/4	7.3	67/11	VG7882LS+3801B	56/16	VG7882LS+3801D	30/45	VG7882LS+3801E
Two-Way Normally Open — 3/8 in. Union Sweat End Connections								
VG7271CS	1/2	0.73	186	VG7271CS+3801B	157	VG7271CS+3801D	84	VG7271CS+3801E
VG7271ES	1/2	1.8	186	VG7271ES+3801B	157	VG7271ES+3801D	84	VG7271ES+3801E
VG7271GS	1/2	4.6	105	VG7271GS+3801B	89	VG7271GS+3801D	48	VG7271GS+3801E

The performance specifications are nominal and conform to acceptable industry standards. For applications at conditions beyond these specifications, consult the local Johnson Controls office. Johnson Controls shall not be liable for damages resulting from misapplication or misuse of its products. © 2019 Johnson Controls www.johnsoncontrols.com

**VG7000 Series Brass Trim Globe Valves with V-3801 Compact Pneumatic Actuators
(Continued)**

Actuator Code Number			V-3801-8001					
Mounting Kit			VG7000-1010		VG7000-1011		VG7000-1012	
Spring Range			3 psig to 6 psig		4 psig to 8 psig		9 psig to 13 psig	
Valve Code Number	Size, in.	Cv	Closeoff psig	Code Number	Closeoff psig	Code Number	Closeoff psig	Code Number
Two-Way Normally Closed — 3/8 in. Union Sweat End Connections								
VG7471CS	1/2	0.73	37	VG7471CS+3801B	57	VG7471CS+3801D	158	VG7471CS+3801E
VG7471ES	1/2	1.8	37	VG7471ES+3801B	57	VG7471ES+3801D	158	VG7471ES+3801E
VG7471GS	1/2	4.6	18	VG7471GS+3801B	28	VG7471GS+3801D	76	VG7471GS+3801E
Three-Way Mixing — 3/8 in. Union Sweat End Connections								
VG7872CS	1/2	0.73	186/37	VG7872CS+3801B	157/57	VG7872CS+3801D	84/158	VG7872CS+3801E
VG7872ES	1/2	1.8	186/37	VG7872ES+3801B	157/57	VG7872ES+3801D	84/158	VG7872ES+3801E
VG7872GS	1/2	4.6	105/18	VG7872GS+3801B	89/28	VG7872GS+3801D	48/76	VG7872GS+3801E
Two-Way Normally Open — 3/4 in. Union Sweat End Connections								
VG7291CS	1/2	0.73	186	VG7291CS+3801B	157	VG7291CS+3801D	84	VG7291CS+3801E
VG7291ES	1/2	1.8	186	VG7291ES+3801B	157	VG7291ES+3801D	84	VG7291ES+3801E
VG7291GS	1/2	4.6	105	VG7291GS+3801B	89	VG7291GS+3801D	48	VG7291GS+3801E
Two-Way Normally Closed — 3/4 in. Union Sweat End Connections								
VG7491CS	1/2	0.73	37	VG7491CS+3801B	57	VG7491CS+3801D	158	VG7491CS+3801E
VG7491ES	1/2	1.8	37	VG7491ES+3801B	57	VG7491ES+3801D	158	VG7491ES+3801E
VG7491GS	1/2	4.6	18	VG7491GS+3801B	28	VG7491GS+3801D	76	VG7491GS+3801E
Three-Way Mixing — 3/4 in. Union Sweat End Connections								
VG7892CS	1/2	0.73	186/37	VG7892CS+3801B	157/57	VG7892CS+3801D	84/158	VG7892CS+3801E
VG7892ES	1/2	1.8	186/37	VG7892ES+3801B	157/57	VG7892ES+3801D	84/158	VG7892ES+3801E
VG7892GS	1/2	4.6	105/18	VG7892GS+3801B	89/28	VG7892GS+3801D	48/76	VG7892GS+3801E
Two-Way Normally Open — Union Globe End Connections								
VG7251CS	1/2	0.73	186	VG7251CS+3801B	157	VG7251CS+3801D	84	VG7251CS+3801E
VG7251ES	1/2	1.8	186	VG7251ES+3801B	157	VG7251ES+3801D	84	VG7251ES+3801E
VG7251GS	1/2	4.6	105	VG7251GS+3801B	89	VG7251GS+3801D	48	VG7251GS+3801E
VG7251LS	3/4	7.3	67	VG7251LS+3801B	56	VG7251LS+3801D	30	VG7251LS+3801E
Two-Way Normally Closed — Union Globe End Connections								
VG7451CS	1/2	0.73	37	VG7451CS+3801B	57	VG7451CS+3801D	158	VG7451CS+3801E
VG7451ES	1/2	1.8	37	VG7451ES+3801B	57	VG7451ES+3801D	158	VG7451ES+3801E
VG7451GS	1/2	4.6	18	VG7451GS+3801B	28	VG7451GS+3801D	76	VG7451GS+3801E
Two-Way Normally Open — Union Angle End Connections								
VG7551CS	1/2	0.73	186	VG7551CS+3801B	157	VG7551CS+3801D	84	VG7551CS+3801E
VG7551ES	1/2	1.8	186	VG7551ES+3801B	157	VG7551ES+3801D	84	VG7551ES+3801E
VG7551GS	1/2	4.6	105	VG7551GS+3801B	89	VG7551GS+3801D	48	VG7551GS+3801E
VG7551LS	3/4	7.3	67	VG7551LS+3801B	56	VG7551LS+3801D	30	VG7551LS+3801E

The performance specifications are nominal and conform to acceptable industry standards. For applications at conditions beyond these specifications, consult the local Johnson Controls office. Johnson Controls shall not be liable for damages resulting from misapplication or misuse of its products. © 2019 Johnson Controls www.johnsoncontrols.com

VG7000 Series Brass Trim Globe Valves with V-3801 Compact Pneumatic Actuators (Continued)

Technical Specifications

VG7000 Series Brass Trim Globe Valves with V-3801 Compact Pneumatic Actuators		
Service¹		Hot Water, Chilled Water, 50/50 Glycol Solutions, and Steam for HVAC Systems
Fluid Temperature Limits	Water	35°F to 248°F (2°C to 120°C)
	Steam	15 psig (103 kPa) Saturated Steam
Maximum Allowable Pressure/Temperature	Water	400 psig (2,756 kPa) up to 150°F (66°C) Decreasing to 365 psig (2,515 kPa) at 248°F (120°C)
	Steam	15 psig (103 kPa) Saturated Steam at 248°F (120°C)
Valve Body Pressure/Temperature Rating		Meets Requirements of ANSI B16.15, Class 250
Maximum Recommended Operating Pressure Drop	Water	35 psig (241 kPa)
	Steam	15 psig (103 kPa)
Flow Characteristics	Two-Way Valves	Equal Percentage
	Three-Way Valves	Linear Flow Characteristics
Rangeability²		> 25:1 According to EN60534-2-4 for the 1/2 in. Size, Cv 0.73, Valve Bodies > 100:1 According to EN60534-2-4 for All Other Valves
Leakage		0.01% of Maximum Flow per ANSI/FCI 70-2, Class 4
Actuator Ambient Operating Temperature Limits		-20°F to 150°F (-29°C to 66°C)
Maximum Actuator Supply Pressure		25 psig (172 kPa) Maximum
Materials	Body	Cast Bronze
	Bonnet	Brass
	Stem	Stainless Steel
	Plug	Brass
	Seat	Brass against Molded Elastomeric Disk
	Packing	Self-Adjusting Ethylene Propylene Rubber (EPR) Ring Pack U-Cups
Compliance	Canada	CRN: 0C1099.9087YTN

1. Refer to the VDI 2035 Guideline for recommended proper water treatment.
2. Rangeability is defined as the ratio of maximum controllable flow to minimum controllable flow.



This product is made of copper alloy, which contains lead. The product is therefore not to be used on drinking water.



This product can expose you to chemicals including lead, which is known to the State of California to cause cancer, birth defects, or other reproductive harm. For more information, go to www.P65Warnings.ca.gov.

WARNING: BRASS MAY CONTAIN LEAD

To fulfill our obligations towards Article 33, in accordance to the European REACH Regulation No 1907/2006 EC, we hereby inform you that this article contains the following Substances of Very High Concern mentioned on the Candidate list:

- Lead

VG7000 Series Brass Trim Globe Valves with V-3000 Pneumatic Actuators

Description

VG7000 Series Brass Trim Globe Valves with V-3000 Pneumatic Actuators control hot or chilled water or 38 psig saturated steam.

Refer to the *VG7000 Series Bronze Control Valves Product Bulletin (LIT-977140)* for important product application information.

- fluid temperature: 35°F to 284°F (2°C to 140°C), 38 psig saturated steam
- valve body static pressure rating: ANSI Class 250
- factory or field assembly
- for optional V-9502-90 Positioner, add a **P** to the end of the code number (not available with enclosed spring actuator)



V-3000-8012 Pneumatic Actuator

Features

- rugged actuator die-cast enclosure, fits VG7000 Series valves 1/2 through 2 in.
- effective diaphragm area: 8 sq. in.
- controls: hot or chilled water, 38 psig saturated steam
- valve trim: brass
- maximum supply air pressure: 25 psig (172 kPa)

Repair Information

If the VG7000 Series Globe Valve fails to operate within its specifications, replace the valve body, actuator, or entire assembly. For replacement parts, contact the nearest Johnson Controls® representative.

Selection Charts

VG7000 Series Valve Assemblies with V-3000-8012 Exposed Pneumatic Actuators (Part 1 of 3)

Actuator Code Number		V-3000-8012							
Mounting Kit	1/2 in. and 3/4 in.		VG7000-1001		VG7000-1002		VG7000-1003		
	1 in. and 1-1/4 in.		VG7000-1004		VG7000-1005		VG7000-1006		
	1-1/2 in. and 2 in.		VG7000-1007		VG7000-1008		VG7000-1009		
Spring Range			3 psig to 6 psig			4 psig to 8 psig		9 psig to 13 psig	
Valve Code Number	Size, in.	Cv	Closeoff psig	Code Number	Closeoff psig	Code Number	Closeoff psig	Code Number	
Two-Way Normally Open — NPT End Connections (To specify a factory-mounted pneumatic positioner, add a P to the end of the code number.)									
VG7241CT	1/2	0.73	365	VG7241CT+3008B	339	VG7241CT+3008D	191	VG7241CT+3008E	
VG7241ET	1/2	1.8	365	VG7241ET+3008B	339	VG7241ET+3008D	191	VG7241ET+3008E	
VG7241GT	1/2	4.6	225	VG7241GT+3008B	192	VG7241GT+3008D	108	VG7241GT+3008E	
VG7241LT	3/4	7.3	144	VG7241LT+3008B	122	VG7241LT+3008D	69	VG7241LT+3008E	
VG7241NT	1	11.6	90	VG7241NT+3008B	76	VG7241NT+3008D	42	VG7241NT+3008E	
VG7241PT	1-1/4	18.5	55	VG7241PT+3008B	47	VG7241PT+3008D	26	VG7241PT+3008E	
VG7241RT	1-1/2	28.9	35	VG7241RT+3008B	30	VG7241RT+3008D	16	VG7241RT+3008E	
VG7241ST	2	46.2	22	VG7241ST+3008B	19	VG7241ST+3008D	11	VG7241ST+3008E	
Two-Way Normally Closed — NPT End Connections (To specify a factory-mounted pneumatic positioner, add a P to the end of the code number.)									
VG7441CT	1/2	0.73	100	VG7441CT+3008B	142	VG7441CT+3008D	348	VG7441CT+3008E	
VG7441ET	1/2	1.8	100	VG7441ET+3008B	142	VG7441ET+3008D	348	VG7441ET+3008E	
VG7441GT	1/2	4.6	49	VG7441GT+3008B	68	VG7441GT+3008D	168	VG7441GT+3008E	
VG7441LT	3/4	7.3	29	VG7441LT+3008B	41	VG7441LT+3008D	100	VG7441LT+3008E	
VG7441NT	1	11.6	17	VG7441NT+3008B	25	VG7441NT+3008D	65	VG7441NT+3008E	
VG7441PT	1-1/4	18.5	10	VG7441PT+3008B	14	VG7441PT+3008D	37	VG7441PT+3008E	
VG7441RT	1-1/2	28.9	6	VG7441RT+3008B	9	VG7441RT+3008D	23	VG7441RT+3008E	
VG7441ST	2	46.2	4	VG7441ST+3008B	6	VG7441ST+3008D	14	VG7441ST+3008E	
Three-Way Mixing — NPT End Connections (To specify a factory-mounted pneumatic positioner, add a P to the end of the code number.)									
VG7842CT	1/2	0.73	365/100	VG7842CT+3008B	339/142	VG7842CT+3008D	191/348	VG7842CT+3008E	
VG7842ET	1/2	1.8	365/100	VG7842ET+3008B	339/142	VG7842ET+3008D	191/348	VG7842ET+3008E	
VG7842GT	1/2	4.6	225/49	VG7842GT+3008B	192/68	VG7842GT+3008D	108/168	VG7842GT+3008E	
VG7842LT	3/4	7.3	144/29	VG7842LT+3008B	122/41	VG7842LT+3008D	69/100	VG7842LT+3008E	
VG7842NT	1	11.6	90/17	VG7842NT+3008B	76/25	VG7842NT+3008D	42/65	VG7842NT+3008E	
VG7842PT	1-1/4	18.5	55/10	VG7842PT+3008B	47/14	VG7842PT+3008D	26/37	VG7842PT+3008E	
VG7842RT	1-1/2	28.9	35/6	VG7842RT+3008B	30/9	VG7842RT+3008D	16/23	VG7842RT+3008E	
VG7842ST	2	46.2	22/4	VG7842ST+3008B	19/6	VG7842ST+3008D	11/14	VG7842ST+3008E	

The performance specifications are nominal and conform to acceptable industry standards. For applications at conditions beyond these specifications, consult the local Johnson Controls office. Johnson Controls shall not be liable for damages resulting from misapplication or misuse of its products. © 2019 Johnson Controls. www.johnsoncontrols.com

VG7000 Series Brass Trim Globe Valves with V-3000 Pneumatic Actuators (Continued)

VG7000 Series Valve Assemblies with V-3000-8012 Exposed Pneumatic Actuators (Part 2 of 3)

Actuator Code Number			V-3000-8012						
Mounting Kit	1/2 in. and 3/4 in.		VG7000-1001		VG7000-1002		VG7000-1003		
	1 in. and 1-1/4 in.		VG7000-1004		VG7000-1005		VG7000-1006		
	1-1/2 in. and 2 in.		VG7000-1007		VG7000-1008		VG7000-1009		
Spring Range			3 psig to 6 psig			4 psig to 8 psig		9 psig to 13 psig	
Valve Code Number	Size, in.	Cv	Closeoff psig	Code Number	Closeoff psig	Code Number	Closeoff psig	Code Number	
Two-Way Normally Open — Union Sweat End Connections (To specify a factory-mounted pneumatic postioner, add a P to the end of the code number.)									
VG7281CT	1/2	0.73	365	VG7281CT+3008B	339	VG7281CT+3008D	191	VG7281CT+3008E	
VG7281ET	1/2	1.8	365	VG7281ET+3008B	339	VG7281ET+3008D	191	VG7281ET+3008E	
VG7281GT	1/2	4.6	225	VG7281GT+3008B	192	VG7281GT+3008D	108	VG7281GT+3008E	
VG7281LT	3/4	7.3	144	VG7281LT+3008B	122	VG7281LT+3008D	69	VG7281LT+3008E	
VG7281NT	1	11.6	90	VG7281NT+3008B	76	VG7281NT+3008D	42	VG7281NT+3008E	
VG7281PT	1-1/4	18.5	55	VG7281PT+3008B	47	VG7281PT+3008D	26	VG7281PT+3008E	
VG7281RT	1-1/2	28.9	35	VG7281RT+3008B	30	VG7281RT+3008D	16	VG7281RT+3008E	
VG7281ST	2	46.2	22	VG7281ST+3008B	19	VG7281ST+3008D	11	VG7281ST+3008E	
Two-Way Normally Closed — Union Sweat End Connections (To specify a factory-mounted pneumatic postioner, add a P to the end of the code number.)									
VG7481CT	1/2	0.73	100	VG7481CT+3008B	142	VG7481CT+3008D	348	VG7481CT+3008E	
VG7481ET	1/2	1.8	100	VG7481ET+3008B	142	VG7481ET+3008D	348	VG7481ET+3008E	
VG7481GT	1/2	4.6	49	VG7481GT+3008B	68	VG7481GT+3008D	168	VG7481GT+3008E	
VG7481LT	3/4	7.3	29	VG7481LT+3008B	41	VG7481LT+3008D	100	VG7481LT+3008E	
VG7481NT	1	11.6	17	VG7481NT+3008B	25	VG7481NT+3008D	65	VG7481NT+3008E	
VG7481PT	1-1/4	18.5	10	VG7481PT+3008B	14	VG7481PT+3008D	37	VG7481PT+3008E	
VG7481RT	1-1/2	28.9	6	VG7481RT+3008B	9	VG7481RT+3008D	23	VG7481RT+3008E	
VG7481ST	2	46.2	4	VG7481ST+3008B	6	VG7481ST+3008D	14	VG7481ST+3008E	
Three-Way Mixing — Union Sweat End Connections (To specify a factory-mounted pneumatic postioner, add a P to the end of the code number.)									
VG7882CT	1/2	0.73	365/100	VG7882CT+3008B	339/142	VG7882CT+3008D	191/348	VG7882CT+3008E	
VG7882ET	1/2	1.8	365/100	VG7882ET+3008B	339/142	VG7882ET+3008D	191/348	VG7882ET+3008E	
VG7882GT	1/2	4.6	225/49	VG7882GT+3008B	192/68	VG7882GT+3008D	108/168	VG7882GT+3008E	
VG7882LT	3/4	7.3	144/29	VG7882LT+3008B	122/41	VG7882LT+3008D	69/100	VG7882LT+3008E	
VG7882NT	1	11.6	90/17	VG7882NT+3008B	76/25	VG7882NT+3008D	42/65	VG7882NT+3008E	
VG7882PT	1-1/4	18.5	55/10	VG7882PT+3008B	47/14	VG7882PT+3008D	26/37	VG7882PT+3008E	
VG7882RT	1-1/2	28.9	35/6	VG7882RT+3008B	30/9	VG7882RT+3008D	16/23	VG7882RT+3008E	
VG7882ST	2	46.2	22/4	VG7882ST+3008B	19/6	VG7882ST+3008D	11/14	VG7882ST+3008E	
Two-Way Normally Open — 3/8 in. Union Sweat End Connections (To specify a factory-mounted pneumatic postioner, add a P to the end of the code number.)									
VG7271CT	1/2	0.73	365	VG7271CT+3008B	339	VG7271CT+3008D	191	VG7271CT+3008E	
VG7271ET	1/2	1.8	365	VG7271ET+3008B	339	VG7271ET+3008D	191	VG7271ET+3008E	
VG7271GT	1/2	4.6	225	VG7271GT+3008B	192	VG7271GT+3008D	108	VG7271GT+3008E	
Two-Way Normally Closed — 3/8 in. Union Sweat End Connections (To specify a factory-mounted pneumatic postioner, add a P to the end of the code number.)									
VG7471CT	1/2	0.73	100	VG7471CT+3008B	142	VG7471CT+3008D	348	VG7471CT+3008E	
VG7471ET	1/2	1.8	100	VG7471ET+3008B	142	VG7471ET+3008D	348	VG7471ET+3008E	
VG7471GT	1/2	4.6	49	VG7471GT+3008B	68	VG7471GT+3008D	168	VG7471GT+3008E	
Three-Way Mixing — 3/8 in. Union Sweat End Connections (To specify a factory-mounted pneumatic postioner, add a P to the end of the code number.)									
VG7872CT	1/2	0.73	365/100	VG7872CT+3008B	339/142	VG7872CT+3008D	191/348	VG7872CT+3008E	
VG7872ET	1/2	1.8	365/100	VG7872ET+3008B	339/142	VG7872ET+3008D	191/348	VG7872ET+3008E	
VG7872GT	1/2	4.6	225/49	VG7872GT+3008B	192/68	VG7872GT+3008D	108/168	VG7872GT+3008E	
Two-Way Normally Open — 3/4 in. Union Sweat End Connections (To specify a factory-mounted pneumatic postioner, add a P to the end of the code number.)									
VG7291CT	1/2	0.73	365	VG7291CT+3008B	339	VG7291CT+3008D	191	VG7291CT+3008E	
VG7291ET	1/2	1.8	365	VG7291ET+3008B	339	VG7291ET+3008D	191	VG7291ET+3008E	
VG7291GT	1/2	4.6	225	VG7291GT+3008B	192	VG7291GT+3008D	108	VG7291GT+3008E	
Two-Way Normally Closed — 3/4 in. Union Sweat End Connections (To specify a factory-mounted pneumatic postioner, add a P to the end of the code number.)									
VG7491CT	1/2	0.73	100	VG7491CT+3008B	142	VG7491CT+3008D	348	VG7491CT+3008E	
VG7491ET	1/2	1.8	100	VG7491ET+3008B	142	VG7491ET+3008D	348	VG7491ET+3008E	
VG7491GT	1/2	4.6	49	VG7491GT+3008B	68	VG7491GT+3008D	168	VG7491GT+3008E	

VG7000 Series Brass Trim Globe Valves with V-3000 Pneumatic Actuators (Continued)

VG7000 Series Valve Assemblies with V-3000-8012 Exposed Pneumatic Actuators (Part 3 of 3)

Actuator Code Number		V-3000-8012							
Mounting Kit	1/2 in. and 3/4 in.		VG7000-1001		VG7000-1002		VG7000-1003		
	1 in. and 1-1/4 in.		VG7000-1004		VG7000-1005		VG7000-1006		
	1-1/2 in. and 2 in.		VG7000-1007		VG7000-1008		VG7000-1009		
Spring Range			3 psig to 6 psig			4 psig to 8 psig		9 psig to 13 psig	
Valve Code Number	Size, in.	Cv	Closeoff psig	Code Number	Closeoff psig	Code Number	Closeoff psig	Code Number	
Three-Way Mixing — 3/4 in. Union Sweat End Connections (To specify a factory-mounted pneumatic positioner, add a P to the end of the code number.)									
VG7892CT	1/2	0.73	365/100	VG7892CT+3008B	339/142	VG7892CT+3008D	191/348	VG7892CT+3008E	
VG7892ET	1/2	1.8	365/100	VG7892ET+3008B	339/142	VG7892ET+3008D	191/348	VG7892ET+3008E	
VG7892GT	1/2	4.6	225/49	VG7892GT+3008B	192/68	VG7892GT+3008D	108/168	VG7892GT+3008E	
Two-Way Normally Open — Union Globe End Connections (No Positioner Option Available)									
VG7251CT	1/2	0.73	365	VG7251CT+3008B	339	VG7251CT+3008D	191	VG7251CT+3008E	
VG7251ET	1/2	1.8	365	VG7251ET+3008B	339	VG7251ET+3008D	191	VG7251ET+3008E	
VG7251GT	1/2	4.6	225	VG7251GT+3008B	192	VG7251GT+3008D	108	VG7251GT+3008E	
VG7251LT	3/4	7.3	144	VG7251LT+3008B	122	VG7251LT+3008D	69	VG7251LT+3008E	
VG7251NT	1	11.6	90	VG7251NT+3008B	76	VG7251NT+3008D	42	VG7251NT+3008E	
VG7251PT	1-1/4	18.5	55	VG7251PT+3008B	47	VG7251PT+3008D	26	VG7251PT+3008E	
VG7251RT	1-1/2	28.9	35	VG7251RT+3008B	30	VG7251RT+3008D	16	VG7251RT+3008E	
Two-Way Normally Closed — Union Globe End Connections (No Positioner Option Available)									
VG7451CT	1/2	0.73	100	VG7451CT+3008B	142	VG7451CT+3008D	348	VG7451CT+3008E	
VG7451ET	1/2	1.8	100	VG7451ET+3008B	142	VG7451ET+3008D	348	VG7451ET+3008E	
VG7451GT	1/2	4.6	49	VG7451GT+3008B	68	VG7451GT+3008D	168	VG7451GT+3008E	
Two-Way Normally Open — Union Angle End Connections (No Positioner Option Available)									
VG7551CT	1/2	0.73	365	VG7551CT+3008B	339	VG7551CT+3008D	191	VG7551CT+3008E	
VG7551ET	1/2	1.8	365	VG7551ET+3008B	339	VG7551ET+3008D	191	VG7551ET+3008E	
VG7551GT	1/2	4.6	225	VG7551GT+3008B	192	VG7551GT+3008D	108	VG7551GT+3008E	
VG7551LT	3/4	7.3	144	VG7551LT+3008B	122	VG7551LT+3008D	69	VG7551LT+3008E	
VG7551NT	1	11.6	90	VG7551NT+3008B	76	VG7551NT+3008D	42	VG7551NT+3008E	
VG7551PT	1-1/4	18.5	55	VG7551PT+3008B	47	VG7551PT+3008D	26	VG7551PT+3008E	
VG7551RT	1-1/2	28.9	35	VG7551RT+3008B	30	VG7551RT+3008D	16	VG7551RT+3008E	

VG7000 Series Valve Assemblies with V-3000-8003 Enclosed Pneumatic Actuators (Part 1 of 3)

Actuator Code Number		V-3000-8003							
Mounting Kit	1/2 in. and 3/4 in.		VG7000-1001		VG7000-1002		VG7000-1003		
	1 in. and 1-1/4 in.		VG7000-1004		VG7000-1005		VG7000-1006		
	1-1/2 in. and 2 in.		VG7000-1007		VG7000-1008		VG7000-1009		
Spring Range			3 psig to 6 psig			4 psig to 8 psig		9 psig to 13 psig	
Valve Code Number	Size, in.	Cv	Closeoff psig	Code Number	Closeoff psig	Code Number	Closeoff psig	Code Number	
Two-Way Normally Open — NPT End Connections									
VG7241CT	1/2	0.73	365	VG7241CT+3003B	339	VG7241CT+3003D	191	VG7241CT+3003E	
VG7241ET	1/2	1.8	365	VG7241ET+3003B	339	VG7241ET+3003D	191	VG7241ET+3003E	
VG7241GT	1/2	4.6	225	VG7241GT+3003B	192	VG7241GT+3003D	108	VG7241GT+3003E	
VG7241LT	3/4	7.3	144	VG7241LT+3003B	122	VG7241LT+3003D	69	VG7241LT+3003E	
VG7241NT	1	11.6	90	VG7241NT+3003B	76	VG7241NT+3003D	42	VG7241NT+3003E	
VG7241PT	1-1/4	18.5	55	VG7241PT+3003B	47	VG7241PT+3003D	26	VG7241PT+3003E	
VG7241RT	1-1/2	28.9	35	VG7241RT+3003B	30	VG7241RT+3003D	16	VG7241RT+3003E	
VG7241ST	2	46.2	22	VG7241ST+3003B	19	VG7241ST+3003D	11	VG7241ST+3003E	
Two-Way Normally Closed — NPT End Connections									
VG7441CT	1/2	0.73	100	VG7441CT+3003B	142	VG7441CT+3003D	348	VG7441CT+3003E	
VG7441ET	1/2	1.8	100	VG7441ET+3003B	142	VG7441ET+3003D	348	VG7441ET+3003E	
VG7441GT	1/2	4.6	49	VG7441GT+3003B	68	VG7441GT+3003D	168	VG7441GT+3003E	
VG7441LT	3/4	7.3	29	VG7441LT+3003B	41	VG7441LT+3003D	100	VG7441LT+3003E	
VG7441NT	1	11.6	17	VG7441NT+3003B	25	VG7441NT+3003D	65	VG7441NT+3003E	
VG7441PT	1-1/4	18.5	10	VG7441PT+3003B	14	VG7441PT+3003D	37	VG7441PT+3003E	
VG7441RT	1-1/2	28.9	6	VG7441RT+3003B	9	VG7441RT+3003D	23	VG7441RT+3003E	
VG7441ST	2	46.2	4	VG7441ST+3003B	6	VG7441ST+3003D	14	VG7441ST+3003E	

The performance specifications are nominal and conform to acceptable industry standards. For applications at conditions beyond these specifications, consult the local Johnson Controls office. Johnson Controls shall not be liable for damages resulting from misapplication or misuse of its products. © 2019 Johnson Controls. www.johnsoncontrols.com

VG7000 Series Brass Trim Globe Valves with V-3000 Pneumatic Actuators (Continued)

VG7000 Series Valve Assemblies with V-3000-8003 Enclosed Pneumatic Actuators (Part 2 of 3)

Actuator Code Number		V-3000-8003						
Mounting Kit	1/2 in. and 3/4 in.	VG7000-1001			VG7000-1002		VG7000-1003	
	1 in. and 1-1/4 in.	VG7000-1004			VG7000-1005		VG7000-1006	
	1-1/2 in. and 2 in.	VG7000-1007			VG7000-1008		VG7000-1009	
Spring Range		3 psig to 6 psig			4 psig to 8 psig		9 psig to 13 psig	
Valve Code Number	Size, in.	Cv	Closeoff psig	Code Number	Closeoff psig	Code Number	Closeoff psig	Code Number
Three-Way Mixing — NPT End Connections								
VG7842CT	1/2	0.73	365/100	VG7842CT+3003B	339/142	VG7842CT+3003D	191/348	VG7842CT+3003E
VG7842ET	1/2	1.8	365/100	VG7842ET+3003B	339/142	VG7842ET+3003D	191/348	VG7842ET+3003E
VG7842GT	1/2	4.6	225/49	VG7842GT+3003B	192/68	VG7842GT+3003D	108/168	VG7842GT+3003E
VG7842LT	3/4	7.3	144/29	VG7842LT+3003B	122/41	VG7842LT+3003D	69/100	VG7842LT+3003E
VG7842NT	1	11.6	90/17	VG7842NT+3003B	76/25	VG7842NT+3003D	42/65	VG7842NT+3003E
VG7842PT	1-1/4	18.5	55/10	VG7842PT+3003B	47/14	VG7842PT+3003D	26/37	VG7842PT+3003E
VG7842RT	1-1/2	28.9	35/6	VG7842RT+3003B	30/9	VG7842RT+3003D	16/23	VG7842RT+3003E
VG7842ST	2	46.2	22/4	VG7842ST+3003B	19/6	VG7842ST+3003D	11/14	VG7842ST+3003E
Two-Way Normally Open — Union Sweat End Connections								
VG7281CT	1/2	0.73	365	VG7281CT+3003B	339	VG7281CT+3003D	191	VG7281CT+3003E
VG7281ET	1/2	1.8	365	VG7281ET+3003B	339	VG7281ET+3003D	191	VG7281ET+3003E
VG7281GT	1/2	4.6	225	VG7281GT+3003B	192	VG7281GT+3003D	108	VG7281GT+3003E
VG7281LT	3/4	7.3	144	VG7281LT+3003B	122	VG7281LT+3003D	69	VG7281LT+3003E
VG7281NT	1	11.6	90	VG7281NT+3003B	76	VG7281NT+3003D	42	VG7281NT+3003E
VG7281PT	1-1/4	18.5	55	VG7281PT+3003B	47	VG7281PT+3003D	26	VG7281PT+3003E
VG7281RT	1-1/2	28.9	35	VG7281RT+3003B	30	VG7281RT+3003D	16	VG7281RT+3003E
VG7281ST	2	46.2	22	VG7281ST+3003B	19	VG7281ST+3003D	11	VG7281ST+3003E
Two-Way Normally Closed — Union Sweat End Connections								
VG7481CT	1/2	0.73	100	VG7481CT+3003B	142	VG7481CT+3003D	348	VG7481CT+3003E
VG7481ET	1/2	1.8	100	VG7481ET+3003B	142	VG7481ET+3003D	348	VG7481ET+3003E
VG7481GT	1/2	4.6	49	VG7481GT+3003B	68	VG7481GT+3003D	168	VG7481GT+3003E
VG7481LT	3/4	7.3	29	VG7481LT+3003B	41	VG7481LT+3003D	100	VG7481LT+3003E
VG7481NT	1	11.6	17	VG7481NT+3003B	25	VG7481NT+3003D	65	VG7481NT+3003E
VG7481PT	1-1/4	18.5	10	VG7481PT+3003B	14	VG7481PT+3003D	37	VG7481PT+3003E
VG7481RT	1-1/2	28.9	6	VG7481RT+3003B	9	VG7481RT+3003D	23	VG7481RT+3003E
VG7481ST	2	46.2	4	VG7481ST+3003B	6	VG7481ST+3003D	14	VG7481ST+3003E
Three-Way Mixing — Union Sweat End Connections								
VG7882CT	1/2	0.73	365/100	VG7882CT+3003B	339/142	VG7882CT+3003D	191/348	VG7882CT+3003E
VG7882ET	1/2	1.8	365/100	VG7882ET+3003B	339/142	VG7882ET+3003D	191/348	VG7882ET+3003E
VG7882GT	1/2	4.6	225/49	VG7882GT+3003B	192/68	VG7882GT+3003D	108/168	VG7882GT+3003E
VG7882LT	3/4	7.3	144/29	VG7882LT+3003B	122/41	VG7882LT+3003D	69/100	VG7882LT+3003E
VG7882NT	1	11.6	90/17	VG7882NT+3003B	76/25	VG7882NT+3003D	42/65	VG7882NT+3003E
VG7882PT	1-1/4	18.5	55/10	VG7882PT+3003B	47/14	VG7882PT+3003D	26/37	VG7882PT+3003E
VG7882RT	1-1/2	28.9	35/6	VG7882RT+3003B	30/9	VG7882RT+3003D	16/23	VG7882RT+3003E
VG7882ST	2	46.2	22/4	VG7882ST+3003B	19/6	VG7882ST+3003D	11/14	VG7882ST+3003E
Two-Way Normally Open — 3/8 in. Union Sweat End Connections								
VG7271CT	1/2	0.73	365	VG7271CT+3003B	339	VG7271CT+3003D	191	VG7271CT+3003E
VG7271ET	1/2	1.8	365	VG7271ET+3003B	339	VG7271ET+3003D	191	VG7271ET+3003E
VG7271GT	1/2	4.6	225	VG7271GT+3003B	192	VG7271GT+3003D	108	VG7271GT+3003E
Two-Way Normally Closed — 3/8 in. Union Sweat End Connections								
VG7471CT	1/2	0.73	100	VG7471CT+3003B	142	VG7471CT+3003D	348	VG7471CT+3003E
VG7471ET	1/2	1.8	100	VG7471ET+3003B	142	VG7471ET+3003D	348	VG7471ET+3003E
VG7471GT	1/2	4.6	49	VG7471GT+3003B	68	VG7471GT+3003D	168	VG7471GT+3003E
Three-Way Mixing — 3/8 in. Union Sweat End Connections								
VG7872CT	1/2	0.73	365/100	VG7872CT+3003B	339/142	VG7872CT+3003D	191/348	VG7872CT+3003E
VG7872ET	1/2	1.8	365/100	VG7872ET+3003B	339/142	VG7872ET+3003D	191/348	VG7872ET+3003E
VG7872GT	1/2	4.6	225/49	VG7872GT+3003B	192/68	VG7872GT+3003D	108/168	VG7872GT+3003E

VG7000 Series Brass Trim Globe Valves with V-3000 Pneumatic Actuators (Continued)

VG7000 Series Valve Assemblies with V-3000-8003 Enclosed Pneumatic Actuators (Part 3 of 3)

Actuator Code Number			V-3000-8003						
Mounting Kit	1/2 in. and 3/4 in.		VG7000-1001		VG7000-1002		VG7000-1003		
	1 in. and 1-1/4 in.		VG7000-1004		VG7000-1005		VG7000-1006		
	1-1/2 in. and 2 in.		VG7000-1007		VG7000-1008		VG7000-1009		
Spring Range			3 psig to 6 psig			4 psig to 8 psig		9 psig to 13 psig	
Valve Code Number	Size, in.	Cv	Closeoff psig	Code Number	Closeoff psig	Code Number	Closeoff psig	Code Number	
Two-Way Normally Open — 3/4 in. Union Sweat End Connections									
VG7291CT	1/2	0.73	365	VG7291CT+3003B	339	VG7291CT+3003D	191	VG7291CT+3003E	
VG7291ET	1/2	1.8	365	VG7291ET+3003B	339	VG7291ET+3003D	191	VG7291ET+3003E	
VG7291GT	1/2	4.6	225	VG7291GT+3003B	192	VG7291GT+3003D	108	VG7291GT+3003E	
Two-Way Normally Closed — 3/4 in. Union Sweat End Connections									
VG7491CT	1/2	0.73	100	VG7491CT+3003B	142	VG7491CT+3003D	348	VG7491CT+3003E	
VG7491ET	1/2	1.8	100	VG7491ET+3003B	142	VG7491ET+3003D	348	VG7491ET+3003E	
VG7491GT	1/2	4.6	49	VG7491GT+3003B	68	VG7491GT+3003D	168	VG7491GT+3003E	
Three-Way Mixing — 3/4 in. Union Sweat End Connections									
VG7892CT	1/2	0.73	365/100	VG7892CT+3003B	339/142	VG7892CT+3003D	191/348	VG7892CT+3003E	
VG7892ET	1/2	1.8	365/100	VG7892ET+3003B	339/142	VG7892ET+3003D	191/348	VG7892ET+3003E	
VG7892GT	1/2	4.6	225/49	VG7892GT+3003B	192/68	VG7892GT+3003D	108/168	VG7892GT+3003E	
Two-Way Normally Open — Union Globe End Connections									
VG7251CT	1/2	0.73	365	VG7251CT+3003B	339	VG7251CT+3003D	191	VG7251CT+3003E	
VG7251ET	1/2	1.8	365	VG7251ET+3003B	339	VG7251ET+3003D	191	VG7251ET+3003E	
VG7251GT	1/2	4.6	225	VG7251GT+3003B	192	VG7251GT+3003D	108	VG7251GT+3003E	
VG7251LT	3/4	7.3	144	VG7251LT+3003B	122	VG7251LT+3003D	69	VG7251LT+3003E	
VG7251NT	1	11.6	90	VG7251NT+3003B	76	VG7251NT+3003D	42	VG7251NT+3003E	
VG7251PT	1-1/4	18.5	55	VG7251PT+3003B	47	VG7251PT+3003D	26	VG7251PT+3003E	
VG7251RT	1-1/2	28.9	35	VG7251RT+3003B	30	VG7251RT+3003D	16	VG7251RT+3003E	
Two-Way Normally Closed — Union Globe End Connections									
VG7451CT	1/2	0.73	100	VG7451CT+3003B	142	VG7451CT+3003D	348	VG7451CT+3003E	
VG7451ET	1/2	1.8	100	VG7451ET+3003B	142	VG7451ET+3003D	348	VG7451ET+3003E	
VG7451GT	1/2	4.6	49	VG7451GT+3003B	68	VG7451GT+3003D	168	VG7451GT+3003E	
Two-Way Normally Open — Union Angle End Connections									
VG7551CT	1/2	0.73	365	VG7551CT+3003B	339	VG7551CT+3003D	191	VG7551CT+3003E	
VG7551ET	1/2	1.8	365	VG7551ET+3003B	339	VG7551ET+3003D	191	VG7551ET+3003E	
VG7551GT	1/2	4.6	225	VG7551GT+3003B	192	VG7551GT+3003D	108	VG7551GT+3003E	
VG7551LT	3/4	7.3	144	VG7551LT+3003B	122	VG7551LT+3003D	69	VG7551LT+3003E	
VG7551NT	1	11.6	90	VG7551NT+3003B	76	VG7551NT+3003D	42	VG7551NT+3003E	
VG7551PT	1-1/4	18.5	55	VG7551PT+3003B	47	VG7551PT+3003D	26	VG7551PT+3003E	
VG7551RT	1-1/2	28.9	35	VG7551RT+3003B	30	VG7551RT+3003D	16	VG7551RT+3003E	

The performance specifications are nominal and conform to acceptable industry standards. For applications at conditions beyond these specifications, consult the local Johnson Controls office. Johnson Controls shall not be liable for damages resulting from misapplication or misuse of its products. © 2019 Johnson Controls. www.johnsoncontrols.com

VG7000 Series Brass Trim Globe Valves with V-3000 Pneumatic Actuators (Continued)

Technical Specifications

VG7000 Series Brass Trim Globe Valves with V-3000 Pneumatic Actuators		
Service¹		Hot Water, Chilled Water, 50/50 Glycol Solutions, and Steam for HVAC Systems
Fluid Temperature Limits	Water	35°F to 248°F (2°C to 120°C) for V-3000-8003 35°F to 284°F (2°C to 140°C) for V-3000-8011
	Steam	38 psig (262 kPa) Saturated Steam
Maximum Allowable Pressure/Temperature	Water	400 psig (2,756 kPa) up to 150°F (66°C) Decreasing to 365 psig (2,515 kPa) at 248°F (120°C)
	Steam	38 psig (262 kPa) Saturated Steam at 284°F (140°C)
Valve Body Pressure/Temperature Rating		Meets Requirements of ANSI B16.15, Class 250
Maximum Recommended Operating Pressure Drop	Water	35 psig (241 kPa) for 1/2 in. through 1-1/4 in. Valves 30 psig (207 kPa) for 1-1/2 in. and 2 in. Valves
	Steam	15 psig (103 kPa)
Flow Characteristics	Two-Way Valves	Equal Percentage
	Three-Way Valves	Linear Flow Characteristics
Rangeability²		> 25:1 According to EN60534-2-4 for the 1/2 in. Size, Cv 0.73, Valve Bodies > 100:1 According to EN60534-2-4 for All Other Valves
Leakage		0.01% of Maximum Flow per ANSI/FCI 70-2, Class 4
Actuator Ambient Operating Temperature Limits		-20°F to 150°F (-29°C to 66°C)
Maximum Actuator Supply Pressure		25 psig (172 kPa) Maximum
Materials	Body	Cast Bronze
	Bonnet	Brass
	Stem	Stainless Steel
	Plug	Brass
	Seat	Brass against Molded Elastomeric Disk
	Packing	Self-Adjusting Ethylene Propylene Rubber (EPR) Ring Pack U-Cups
Compliance	Canada	CRN: 0C1099.9087YTN

1. Refer to the VDI 2035 Guideline for recommended proper water treatment.
2. Rangeability is defined as the ratio of maximum controllable flow to minimum controllable flow.

WARNING	This product is made of copper alloy, which contains lead. The product is therefore not to be used on drinking water.
----------------	---

WARNING	This product can expose you to chemicals including lead, which is known to the State of California to cause cancer, birth defects, or other reproductive harm. For more information, go to www.P65Warnings.ca.gov .
----------------	---

WARNING: BRASS MAY CONTAIN LEAD	
To fulfill our obligations towards Article 33, in accordance to the European REACH Regulation No 1907/2006 EC, we hereby inform you that this article contains the following Substances of Very High Concern mentioned on the Candidate list:	
<ul style="list-style-type: none"> • Lead 	

VG7000 Series Brass Trim Globe Valves with MP82 Series Pneumatic Actuators

Description

VG7000 Series Brass Trim Globe Valves with MP82 Series Pneumatic Actuators control hot or chilled water or 38 psig saturated steam.

Refer to the *VG7000 Series Bronze Control Valves Product Bulletin (LIT-977140)* for important product application information.

Features

- industrial-grade, drawn-steel actuator fits VG7000 valves 1 through 2 in.
- corrosion-resistant, electro-painted finish
- effective diaphragm area: 25 sq. in.
- controls: hot or chilled water, 38 psig saturated steam
- valve trim: brass

- maximum supply air pressure: 25 psig (172 kPa)
- fluid temperature: 35°F to 284°F (2°C to 140°C), 38 psig saturated steam
- valve body static pressure rating: ANSI Class 250
- factory or field assembly
- for optional V-9502-95 Positioner, change **00** at the end of the code number to **01**

Repair Information

If the VG7000 Series Globe Valve fails to operate within its specifications, replace the valve body, actuator, or entire assembly. For replacement parts, contact the nearest Johnson Controls® representative.

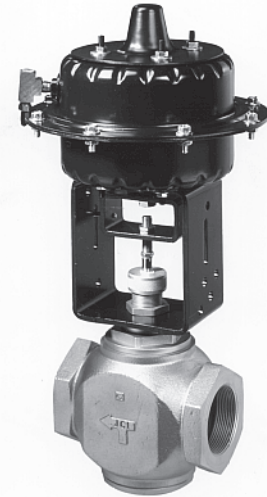

MP82 Series Pneumatic Actuator Mounted on a VG7441 Brass Globe Valve

Selection Chart

Actuator Code Number	1 in. and 1-1/4 in.		MP822C001A		MP822D001A		MP822E001A	
	1-1/2 in. and 2 in.		MP823C001A		MP823D001A		MP823E001A	
Spring Range			3 psig to 7 psig		4 psig to 8 psig		9 psig to 13 psig	
Valve Code Number	Size, in.	Cv	Closeoff psig	Code Number	Closeoff psig	Code Number	Closeoff psig	Code Number
Two-Way Normally Open — NPT End Connections (To specify a factory-mounted pneumatic positioner, change 00 at the end of the code number to 01.)								
VG7241NT	1	11.6	279	VG7241NT+822C00	257	VG7241NT+822D00	148	VG7241NT+822E00
VG7241PT	1-1/4	18.5	170	VG7241PT+822C00	157	VG7241PT+822D00	90	VG7241PT+822E00
VG7241RT	1-1/2	28.9	109	VG7241RT+823C00	100	VG7241RT+823D00	58	VG7241RT+823E00
VG7241ST	2	46.2	70	VG7241ST+823C00	64	VG7241ST+823D00	37	VG7241ST+823E00
Two-Way Normally Closed — NPT End Connections (To specify a factory-mounted pneumatic positioner, change 00 at the end of the code number to 01.)								
VG7441NT	1	11.6	70	VG7441NT+822C00	96	VG7441NT+822D00	223	VG7441NT+822E00
VG7441PT	1-1/4	18.5	40	VG7441PT+822C00	55	VG7441PT+822D00	128	VG7441PT+822E00
VG7441RT	1-1/2	28.9	25	VG7441RT+823C00	34	VG7441RT+823D00	79	VG7441RT+823E00
VG7441ST	2	46.2	16	VG7441ST+823C00	21	VG7441ST+823D00	50	VG7441ST+823E00
Three-Way Mixing — NPT End Connections (To specify a factory-mounted pneumatic positioner, change 00 at the end of the code number to 01.)								
VG7842NT	1	11.6	279/70	VG7842NT+822C00	257/96	VG7842NT+822D00	148/223	VG7842NT+822E00
VG7842PT	1-1/4	18.5	170/40	VG7842PT+822C00	157/55	VG7842PT+822D00	90/128	VG7842PT+822E00
VG7842RT	1-1/2	28.9	109/25	VG7842RT+823C00	100/34	VG7842RT+823D00	58/79	VG7842RT+823E00
VG7842ST	2	46.2	70/16	VG7842ST+823C00	64/21	VG7842ST+823D00	37/50	VG7842ST+823E00

Note: For optional V-9502-95 Positioner, change **00** at the end of the code number to **01**.

VG7000 Series Brass Trim Globe Valves with MP82 Series Pneumatic Actuators (Continued)

Technical Specifications

VG7000 Series Brass Trim Globe Valves with MP82 Series Pneumatic Actuators		
Service¹		Hot Water, Chilled Water, 50/50 Glycol Solutions, and Steam for HVAC Systems
Fluid Temperature Limits	Water	35°F to 284°F (2°C to 140°C)
	Steam	38 psig (262 kPa) Saturated Steam
Maximum Allowable Pressure/Temperature	Water	400 psig (2,756 kPa) up to 150°F (66°C) Decreasing to 365 psig (2,515 kPa) at 248°F (120°C)
	Steam	38 psig (262 kPa) Saturated Steam at 284°F (140°C)
Valve Body Pressure/Temperature Rating		Meets Requirements of ANSI B16.15, Class 250
Maximum Recommended Operating Pressure Drop	Water	35 psig (241 kPa) for 1/2 in. through 1-1/4 in. Valves 30 psig (207 kPa) for 1-1/2 in. and 2 in. Valves
	Steam	15 psig (103 kPa)
Flow Characteristics	Two-Way Valves	Equal Percentage
	Three-Way Valves	Linear Flow Characteristics
Rangeability²		> 100:1 According to EN60534-2-4
Leakage		0.01% of Maximum Flow per ANSI/FCI 70-2, Class 4
Actuator Ambient Operating Temperature Limits		-20°F to 150°F (-29°C to 66°C)
Maximum Actuator Supply Pressure		25 psig (172 kPa) Maximum
Materials	Body	Cast Bronze
	Bonnet	Brass
	Stem	Stainless Steel
	Plug	Brass
	Seat	Brass against Molded Elastomeric Disk
	Packing	Self-Adjusting Ethylene Propylene Rubber (EPR) Ring Pack U-Cups
Compliance	Canada	CRN: 0C1099.9087YTN

1. Refer to the VDI 2035 Guideline for recommended proper water treatment.
2. Rangeability is defined as the ratio of maximum controllable flow to minimum controllable flow.



This product is made of copper alloy, which contains lead. The product is therefore not to be used on drinking water.



This product can expose you to chemicals including lead, which is known to the State of California to cause cancer, birth defects, or other reproductive harm. For more information, go to www.P65Warnings.ca.gov.

WARNING: BRASS MAY CONTAIN LEAD

To fulfill our obligations towards Article 33, in accordance to the European REACH Regulation No 1907/2006 EC, we hereby inform you that this article contains the following Substances of Very High Concern mentioned on the Candidate list:

- Lead

VG7000 Series Stainless Steel Trim Globe Valves with V-3000 Pneumatic Actuators

Description

VG7000 Series Stainless Steel Trim Globe Valves with V-3000 Pneumatic Actuators control hot or chilled water, or 100 psig saturated steam.

Refer to the *VG7000 Series Bronze Control Valves Product Bulletin (LIT-977140)* for important product application information.

Features

- rugged actuator die-cast enclosure fits VG7000 valves 1/2 through 1-1/4 in.
- effective diaphragm area: 8 sq. in.
- controls: hot or chilled water, 100 psig saturated steam
- valve trim: stainless steel
- packing: spring-loaded PTFE and elastomer V-rings

- maximum supply air pressure: 25 psig (172 kPa)
- fluid temperature: 35°F to 338°F (2°C to 170°C)
- valve body static pressure rating: ANSI Class 250
- factory or field assembly
- for optional V-9502-90 Positioner, add a **P** to the end of the code number (not available with enclosed spring actuator)



V-3000-8012 Pneumatic Actuator

Repair Information

If the VG7000 Series Globe Valve fails to operate within its specifications, replace the valve body, actuator, or entire assembly. For replacement parts, contact the nearest Johnson Controls® representative.

Selection Charts

VG7000 Stainless Steel Trim Globe Valve with V-3000-8012 Exposed Pneumatic Actuator

Actuator Code Number		V-3000-8012						
Mounting Kit	1/2 in. and 3/4 in.	VG7000-1001		VG7000-1002		VG7000-1003		
	1 in. and 1-1/4 in.	VG7000-1004		VG7000-1005		VG7000-1006		
	1-1/2 in. and 2 in.	VG7000-1007		VG7000-1008		VG7000-1009		
Spring Range		3 psig to 6 psig			4 psig to 8 psig		9 psig to 13 psig	
Valve Code Number	Size, in.	Cv	Closeoff psig	Code Number	Closeoff psig	Code Number	Closeoff psig	Code Number
Two-Way Normally Open — NPT End Connections (To specify a factory-mounted pneumatic positioner, add P to the end of the code number.)								
VG7243CT	1/2	0.73	299	VG7243CT+3008B	255	VG7243CT+3008D	143	VG7243CT+3008E
VG7243ET	1/2	1.8	299	VG7243ET+3008B	255	VG7243ET+3008D	143	VG7243ET+3008E
VG7243GT	1/2	4.6	169	VG7243GT+3008B	144	VG7243GT+3008D	81	VG7243GT+3008E
VG7243LT	3/4	7.3	108	VG7243LT+3008B	92	VG7243LT+3008D	52	VG7243LT+3008E
VG7243NT	1	11.6	67	VG7243NT+3008B	57	VG7243NT+3008D	32	VG7243NT+3008E
VG7243PT	1-1/4	18.5	41	VG7243PT+3008B	35	VG7243PT+3008D	19	VG7243PT+3008E
Two-Way Normally Closed — NPT End Connections (To specify a factory-mounted pneumatic positioner, add P to the end of the code number.)								
VG7443CT	1/2	0.73	75	VG7443CT+3008B	106	VG7443CT+3008D	261	VG7443CT+3008E
VG7443ET	1/2	1.8	75	VG7443ET+3008B	106	VG7443ET+3008D	261	VG7443ET+3008E
VG7443GT	1/2	4.6	36	VG7443GT+3008B	51	VG7443GT+3008D	126	VG7443GT+3008E
VG7443LT	3/4	7.3	22	VG7443LT+3008B	31	VG7443LT+3008D	75	VG7443LT+3008E
VG7443NT	1	11.6	13	VG7443NT+3008B	19	VG7443NT+3008D	49	VG7443NT+3008E
VG7443PT	1-1/4	18.5	7	VG7443PT+3008B	11	VG7443PT+3008D	28	VG7443PT+3008E
Three-Way Mixing — NPT End Connections (To specify a factory-mounted pneumatic positioner, add P to the end of the code number.)								
VG7844CT	1/2	0.73	299/75	VG7844CT+3008B	255/106	VG7844CT+3008D	143/261	VG7844CT+3008E
VG7844ET	1/2	1.8	299/75	VG7844ET+3008B	255/106	VG7844ET+3008D	143/261	VG7844ET+3008E
VG7844GT	1/2	4.6	169/36	VG7844GT+3008B	144/51	VG7844GT+3008D	81/126	VG7844GT+3008E
VG7844LT	3/4	7.3	108/22	VG7844LT+3008B	92/31	VG7844LT+3008D	52/75	VG7844LT+3008E
VG7844NT	1	11.6	67/13	VG7844NT+3008B	57/19	VG7844NT+3008D	32/49	VG7844NT+3008E
VG7844PT	1-1/4	18.5	41/7	VG7844PT+3008B	35/11	VG7844PT+3008D	19/28	VG7844PT+3008E

WARNING

This product is made of copper alloy, which contains lead. The product is therefore not to be used on drinking water.

WARNING

This product can expose you to chemicals including lead, which is known to the State of California to cause cancer, birth defects, or other reproductive harm. For more information, go to www.P65Warnings.ca.gov.

WARNING: BRASS MAY CONTAIN LEAD

To fulfill our obligations towards Article 33, in accordance to the European REACH Regulation No 1907/2006 EC, we hereby inform you that this article contains the following Substances of Very High Concern mentioned on the Candidate list:

- Lead

VG7000 Series Stainless Steel Trim Globe Valves with V-3000 Pneumatic Actuators (Continued)

VG7000 Stainless Steel Trim Globe Valve with V-3000-8003 Enclosed Pneumatic Actuators

Actuator Code Number		V-3000-8003						
Mounting Kit	1/2 in. and 3/4 in.	VG7000-1001			VG7000-1002		VG7000-1003	
	1 in. and 1-1/4 in.	VG7000-1004			VG7000-1005		VG7000-1006	
	1-1/2 in. and 2 in.	VG7000-1007			VG7000-1008		VG7000-1009	
Spring Range		3 psig to 6 psig			4 psig to 8 psig		9 psig to 13 psig	
Valve Code Number	Size, in.	Cv	Closeoff psig	Code Number	Closeoff psig	Code Number	Closeoff psig	Code Number
Two-Way Normally Open — NPT End Connections								
VG7243CT	1/2	0.73	299	VG7243CT+3003B	255	VG7243CT+3003D	143	VG7243CT+3003E
VG7243ET	1/2	1.8	299	VG7243ET+3003B	255	VG7243ET+3003D	143	VG7243ET+3003E
VG7243GT	1/2	4.6	169	VG7243GT+3003B	144	VG7243GT+3003D	81	VG7243GT+3003E
VG7243LT	3/4	7.3	108	VG7243LT+3003B	92	VG7243LT+3003D	52	VG7243LT+3003E
VG7243NT	1	11.6	67	VG7243NT+3003B	57	VG7243NT+3003D	32	VG7243NT+3003E
VG7243PT	1-1/4	18.5	41	VG7243PT+3003B	35	VG7243PT+3003D	19	VG7243PT+3003E
Two-Way Normally Closed — NPT End Connections								
VG7443CT	1/2	0.73	75	VG7443CT+3003B	106	VG7443CT+3003D	261	VG7443CT+3003E
VG7443ET	1/2	1.8	75	VG7443ET+3003B	106	VG7443ET+3003D	261	VG7443ET+3003E
VG7443GT	1/2	4.6	36	VG7443GT+3003B	51	VG7443GT+3003D	126	VG7443GT+3003E
VG7443LT	3/4	7.3	22	VG7443LT+3003B	31	VG7443LT+3003D	75	VG7443LT+3003E
VG7443NT	1	11.6	13	VG7443NT+3003B	19	VG7443NT+3003D	49	VG7443NT+3003E
VG7443PT	1-1/4	18.5	7	VG7443PT+3003B	11	VG7443PT+3003D	28	VG7443PT+3003E
Three-Way Mixing — NPT End Connections								
VG7844CT	1/2	0.73	299/75	VG7844CT+3003B	255/106	VG7844CT+3003D	143/261	VG7844CT+3003E
VG7844ET	1/2	1.8	299/75	VG7844ET+3003B	255/106	VG7844ET+3003D	143/261	VG7844ET+3003E
VG7844GT	1/2	4.6	169/36	VG7844GT+3003B	144/51	VG7844GT+3003D	81/126	VG7844GT+3003E
VG7844LT	3/4	7.3	108/22	VG7844LT+3003B	92/31	VG7844LT+3003D	52/75	VG7844LT+3003E
VG7844NT	1	11.6	67/13	VG7844NT+3003B	57/19	VG7844NT+3003D	32/49	VG7844NT+3003E
VG7844PT	1-1/4	18.5	41/7	VG7844PT+3003B	35/11	VG7844PT+3003D	19/28	VG7844PT+3003E

Technical Specifications

VG7000 Series Stainless Steel Trim Globe Valves with V-3000 Pneumatic Actuators		
Service ¹	Hot Water, Chilled Water, 50/50 Glycol Solutions, and Steam for HVAC Systems	
Fluid Temperature Limits	Water	35°F to 338°F (2°C to 170°C) for V-3000-8012
	Steam	100 psig (690 kPa) Saturated Steam
Maximum Allowable Pressure/Temperature	Water	400 psig (2,756 kPa) up to 150°F (66°C) Decreasing to 308 psig (2,122 kPa) at 338°F (170°C)
	Steam	100 psig (690 kPa) Saturated Steam
Valve Body Pressure/Temperature Rating	Meets Requirements of ANSI B16.15, Class 250	
Maximum Recommended Operating Pressure Drop	Water	35 psig (241 kPa) for 1/2 in. through 1-1/4 in. Valves; 30 psig (207 kPa) for 1-1/2 in. and 2 in. Valves
	Steam	100 psig (690 kPa)
Flow Characteristics	Two-Way Valves	Equal Percentage
	Three-Way Valves	Linear Flow Characteristics
Rangeability ²	> 25:1 According to EN60534-2-4 for the 1/2 in. Size, Cv 0.73, Valve Bodies > 100:1 According to EN60534-2-4 for All Other Valves	
Leakage	0.05% of Maximum Flow per ANSI/FCI 70-2, Class 4	
Actuator Ambient Operating Temperature Limits	-20°F to 150°F (-29°C to 66°C)	
Maximum Actuator Supply Pressure	25 psig (172 kPa) Maximum	
Materials	Body	Cast Bronze
	Bonnet	Brass
	Stem	Stainless Steel
	Plug	Stainless Steel
	Seat	Stainless Steel
	Packing	Self-Adjusting Ethylene Propylene Rubber (EPR) Ring Pack U-Cups
Compliance	Canada	CRN: 0C1099.9087YTN

1. Refer to the VDI 2035 Guideline for recommended proper water treatment.

2. Rangeability is defined as the ratio of maximum controllable flow to minimum controllable flow.

VG7000 Series Stainless Steel Trim Globe Valves with MP82 Series Pneumatic Actuators

Description

VG7000 Series Stainless Steel Trim Globe Valves with MP82 Series Pneumatic Actuators control hot or chilled water, or 100 psig saturated steam.

Refer to the *VG7000 Series Bronze Control Valves Product Bulletin (LIT-977140)* for important product application information.

- maximum supply air pressure: 25 psig (172 kPa)
- fluid temperature: 35°F to 338°F (2°C to 170°C), 100 psig saturated steam
- valve body static pressure rating: ANSI Class 250
- factory or field assembly
- For optional V-9502-95 Positioner, change **00** at the end of the code number to **01**



MP82 Series Pneumatic Actuator Mounted on VG7443 Brass Globe Valve

Features

- industrial-grade, drawn-steel actuator
- corrosion-resistant, electro-painted finish
- effective diaphragm area: 25 sq. in.
- controls: hot or chilled water, 100 psig saturated steam
- valve trim: stainless steel
- packing: spring-loaded PTFE and elastomer V-rings

Repair Information

If the VG7000 Series Globe Valve fails to operate within its specifications, replace the valve body, actuator, or entire assembly. For replacement parts, contact the nearest Johnson Controls® representative.

Selection Chart

Actuator Code Number			MP821C001B (1/2 and 3/4 in.) MP822C001A (1 and 1-1/4 in.) MP823C001A (1-1/2 and 2 in.)		MP821D001B (1/2 and 3/4 in.) MP822D001A (1 and 1-1/4 in.) MP823D001A (1-1/2 and 2 in.)		MP821E001B (1/2 and 3/4 in.) MP822E001A (1 and 1-1/4 in.) MP823E001A (1-1/2 and 2 in.)	
Spring Range			3 psig to 7 psig		4 psig to 8 psig		9 psig to 13 psig	
Valve Code Number	Size, in.	Cv	Closeoff psig	Code Number	Closeoff psig	Code Number	Closeoff psig	Code Number
Two-Way Normally Open — NPT End Connections (To specify a factory-mounted positioner, change 00 at the end of the code number to 01.)								
VG7243CT	1/2	0.73	308	VG7243CT+821C00	308	VG7243CT+821D00	308	VG7243CT+821E00
VG7243ET	1/2	1.8	308	VG7243ET+821C00	308	VG7243ET+821D00	308	VG7243ET+821E00
VG7243GT	1/2	4.6	308	VG7243GT+821C00	308	VG7243GT+821D00	275	VG7243GT+821E00
VG7243LT	3/4	7.3	308	VG7243LT+821C00	304	VG7243LT+821D00	175	VG7243LT+821E00
VG7243NT	1	11.6	209	VG7243NT+822C00	193	VG7243NT+822D00	111	VG7243NT+822E00
VG7243PT	1-1/4	18.5	128	VG7243PT+822C00	118	VG7243PT+822D00	68	VG7243PT+822E00
VG7243RT	1-1/2	28.9	82	VG7243RT+823C00	75	VG7243RT+823D00	43	VG7243RT+823E00
VG7243ST	2	46.2	52	VG7243ST+823C00	48	VG7243ST+823D00	28	VG7243ST+823E00
Two-Way Normally Closed — NPT End Connections (To specify a factory-mounted positioner, change 00 at the end of the code number to 01.)								
VG7443CT	1/2	0.73	280	VG7443CT+821C00	308	VG7443CT+821D00	308	VG7443CT+821E00
VG7443ET	1/2	1.8	280	VG7443ET+821C00	308	VG7443ET+821D00	308	VG7443ET+821E00
VG7443GT	1/2	4.6	135	VG7443GT+821C00	183	VG7443GT+821D00	308	VG7443GT+821E00
VG7443LT	3/4	7.3	81	VG7443LT+821C00	109	VG7443LT+821D00	252	VG7443LT+821E00
VG7443NT	1	11.6	53	VG7443NT+822C00	72	VG7443NT+822D00	168	VG7443NT+822E00
VG7443PT	1-1/4	18.5	30	VG7443PT+822C00	41	VG7443PT+822D00	96	VG7443PT+822E00
VG7443RT	1-1/2	28.9	19	VG7443RT+823C00	25	VG7443RT+823D00	59	VG7443RT+823E00
VG7443ST	2	46.2	12	VG7443ST+823C00	16	VG7443ST+823D00	37	VG7443ST+823E00
Three-Way Mixing — NPT End Connections (To specify a factory-mounted positioner, change 00 at the end of the code number to 01.)								
VG7844CT	1/2	0.73	308/280	VG7844CT+821C00	308/308	VG7844CT+821D00	308/308	VG7844CT+821E00
VG7844ET	1/2	1.8	308/280	VG7844ET+821C00	308/308	VG7844ET+821D00	308/308	VG7844ET+821E00
VG7844GT	1/2	4.6	308/135	VG7844GT+821C00	308/183	VG7844GT+821D00	275/308	VG7844GT+821E00
VG7844LT	3/4	7.3	308/81	VG7844LT+821C00	304/109	VG7844LT+821D00	175/252	VG7844LT+821E00
VG7844NT	1	11.6	209/53	VG7844NT+822C00	193/72	VG7844NT+822D00	111/168	VG7844NT+822E00
VG7844PT	1-1/4	18.5	128/30	VG7844PT+822C00	118/41	VG7844PT+822D00	68/96	VG7844PT+822E00
VG7844RT	1-1/2	28.9	82/19	VG7844RT+823C00	75/25	VG7844RT+823D00	43/59	VG7844RT+823E00
VG7844ST	2	46.2	52/12	VG7844ST+823C00	48/16	VG7844ST+823D00	28/37	VG7844ST+823E00

Note: For optional V-9502-95 Positioner, change **00** at the end of the code number to **01**.

VG7000 Series Stainless Steel Trim Globe Valves with MP82 Series Pneumatic Actuators (Continued)

Technical Specifications

VG7000 Series Stainless Steel Trim Globe Valves with MP82 Series Pneumatic Actuators		
Service ¹		Hot Water, Chilled Water, 50/50 Glycol Solutions, and Steam for HVAC Systems
Fluid Temperature Limits	Water	35°F to 338°F (2°C to 170°C)
	Steam	100 psig (690 kPa) Saturated Steam
Maximum Allowable Pressure Temperature	Water	400 psig (2,756 kPa) up to 150°F (66°C) Decreasing to 308 psig (2,122 kPa) at 338°F (170°C)
	Steam	100 psig (690 kPa) Saturated Steam
Valve Body Pressure/Temperature Rating		Meets Requirements of ANSI B16.15, Class 250
Maximum Recommended Operating Pressure Drop	Water	35 psig (241 kPa) for 1/2 in. through 1-1/4 in. Valves 30 psig (207 kPa) for 1-1/2 in. and 2 in. Valves
	Steam	100 psig (690 kPa)
Flow Characteristics	Two-Way Valves	Equal Percentage
	Three-Way Valves	Linear Flow Characteristics
Rangeability ²		> 25:1 According to EN60534-2-4 for the 1/2 in. Size, Cv 0.73, Valve Bodies > 100:1 According to EN60534-2-4 for All Other Valves
Leakage		0.05% of Maximum Flow per ANSI/FCI 70-2, Class 4
Actuator Ambient Operating Temperature Limits		-20°F to 150°F (-29°C to 66°C)
Maximum Actuator Supply Pressure		25 psig (172 kPa) Maximum
Materials	Body	Cast Bronze
	Bonnet	Brass
	Stem	Stainless Steel
	Plug	Stainless Steel
	Seat	Stainless Steel
	Packing	Self-Adjusting Ethylene Propylene Rubber (EPR) Ring Pack U-Cups
Compliance	Canada	CRN: 0C1099.9087YTN

1. Refer to the VDI 2035 Guideline for recommended proper water treatment.
2. Rangeability is defined as the ratio of maximum controllable flow to minimum controllable flow.



This product is made of copper alloy, which contains lead. The product is therefore not to be used on drinking water.



This product can expose you to chemicals including lead, which is known to the State of California to cause cancer, birth defects, or other reproductive harm. For more information, go to www.P65Warnings.ca.gov.

WARNING: BRASS MAY CONTAIN LEAD

To fulfill our obligations towards Article 33, in accordance to the European REACH Regulation No 1907/2006 EC, we hereby inform you that this article contains the following Substances of Very High Concern mentioned on the Candidate list:

- Lead

VG7000 Series Stainless Steel Trim Globe Valves with MP84 Series Pneumatic Actuators

Description

VG7000 Series Stainless Steel Trim Globe Valves with MP84 Series Pneumatic Actuators control hot or chilled water, or 100 psig saturated steam.

Refer to the *VG7000 Series Bronze Control Valves Product Bulletin (LIT-977140)* for important product application information.

Features

- industrial-grade, drawn-steel actuator fits VG7000 Series valves 1-1/2 in. and 2 in. with 3/8 in. stem
- corrosion-resistant, electro-painted finish
- effective diaphragm area: 50 sq. in.
- controls: hot or chilled water, 100 psig saturated steam
- valve trim: stainless steel

- packing: spring-loaded PTFE and elastomer V-rings
- maximum supply air pressure: 25 psig (172 kPa)
- fluid temperature: 35°F to 338°F (2°C to 170°C), 100 psig saturated steam
- valve body static pressure rating: ANSI Class 250
- factory or field assembly
- for optional V-9502-95 Positioner, change **00** at the end of the code number to **01**

Repair Information

If the VG7000 Series Globe Valve fails to operate within its specifications, replace the valve body, actuator, or entire assembly. For replacement parts, contact the nearest Johnson Controls® representative.

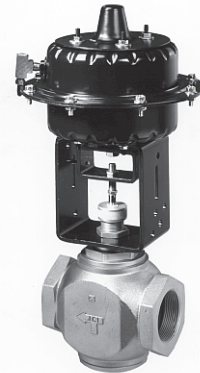

MP84 Series Pneumatic Actuator Mounted on a VG7443 Brass Globe Valve

Selection Chart

Actuator Code Number			MP843C001C (1-1/2 and 2 in.)		MP843D001C (1-1/2 and 2 in.)		MP843E001C (1-1/2 and 2 in.)	
Spring Range			3 psig to 7 psig		4 psig to 8 psig		9 psig to 13 psig	
Valve Code Number	Size, in.	Cv	Closeoff psig	Code Number	Closeoff psig	Code Number	Closeoff psig	Code Number
Two-Way Normally Open — NPT End Connections (To specify a factory-mounted positioner, change 00 at the end of the code number to 01.)								
VG7243RM	1-1/2	28.9	165	VG7243RM+843C00	152	VG7243RM+843D00	88	VG7243RM+843E00
VG7243SM	2	46.2	106	VG7243SM+843C00	97	VG7243SM+843D00	56	VG7243SM+843E00
Two-Way Normally Closed — NPT End Connections (To specify a factory-mounted positioner, change 00 at the end of the code number to 01.)								
VG7443RM	1-1/2	28.9	39	VG7443RM+843C00	53	VG7443RM+843D00	121	VG7443RM+843E00
VG7443SM	2	46.2	24	VG7443SM+843C00	33	VG7443SM+843D00	76	VG7443SM+843E00
Three-Way Mixing — NPT End Connections (To specify a factory-mounted positioner, change 00 at the end of the code number to 01.)								
VG7844RM	1-1/2	28.9	165/39	VG7844RM+843C00	152/53	VG7844RM+843D00	88/121	VG7844RM+843E00
VG7844SM	2	46.2	106/24	VG7844SM+843C00	97/33	VG7844SM+843D00	56/76	VG7844SM+843E00

Note: For optional V-9502-95 Positioner, change **00** at the end of the code number to **01**.

WARNING	This product is made of copper alloy, which contains lead. The product is therefore not to be used on drinking water.
----------------	---

WARNING	This product can expose you to chemicals including lead, which is known to the State of California to cause cancer, birth defects, or other reproductive harm. For more information, go to www.P65Warnings.ca.gov .
----------------	---

<p>WARNING: BRASS MAY CONTAIN LEAD</p> <p>To fulfill our obligations towards Article 33, in accordance to the European REACH Regulation No 1907/2006 EC, we hereby inform you that this article contains the following Substances of Very High Concern mentioned on the Candidate list:</p> <ul style="list-style-type: none"> • Lead

VG7000 Series Stainless Steel Trim Globe Valves with MP84 Series Pneumatic Actuators (Continued)

Technical Specifications

VG7000 Series Stainless Steel Trim Globe Valves with MP84 Series Pneumatic Actuators		
Service ¹		Hot Water, Chilled Water, 50/50 Glycol Solutions, and Steam for HVAC Systems
Fluid Temperature Limits	Water	35°F to 338°F (2°C to 170°C)
	Steam	100 psig (690 kPa) Saturated Steam
Maximum Allowable Pressure/Temperature	Water	400 psig (2,756 kPa) up to 150°F (66°C) Decreasing to 308 psig (2,122 kPa) at 338°F (170°C)
	Steam	100 psig (690 kPa) Saturated Steam
Valve Body Pressure/Temperature Rating		Meets Requirements of ANSI B16.15, Class 250
Maximum Recommended Operating Pressure Drop	Water	30 psig (207 kPa) for 1-1/2 in. and 2 in. Valves
	Steam	100 psig (690 kPa)
Flow Characteristics	Two-Way Valves	Equal Percentage
	Three-Way Valves	Linear Flow Characteristics
Rangeability ²		> 100:1 According to EN60534-2-4
Leakage		0.05% of Maximum Flow per ANSI/FCI 70-2, Class 4
Actuator Ambient Operating Temperature Limits		-20°F to 150°F (-29°C to 66°C)
Maximum Actuator Supply Pressure		25 psig (172 kPa) Maximum
Materials	Body	Cast Bronze
	Bonnet	Brass
	Stem	Stainless Steel
	Plug	Stainless Steel
	Seat	Stainless Steel
	Packing	Self-Adjusting Ethylene Propylene Rubber (EPR) Ring Pack U-Cups
Compliance	Canada	CRN: 0C1099.9087YTN

1. Refer to the VDI 2035 Guideline for recommended proper water treatment.

2. Rangeability is defined as the ratio of maximum controllable flow to minimum controllable flow.

VG7000 Series Bronze Globe Valves for Assembly in the Field

Description

The VG7000 Series Bronze Globe Valves accurately regulate the flow of water or steam in response to the demand of a controller in HVAC systems. These valves are available in normally open, normally closed, and three-way mixing configurations. Both electric and pneumatic actuators are available.

Refer to the *VG7000 Series Bronze Control Valves Product Bulletin (LIT-977140)* for important product application information.

- tight shutoff testing ensures occupant comfort and energy conservation
- standard Johnson Controls® Ring Pack Packings provide industry-leading reliability and operating life
- complete actuator interchangeability allows easy field retrofit or mounting using standardized mounting kits
- all valve sizes available with brass trim or stainless steel trim for use in saturated steam applications up to 100 psig

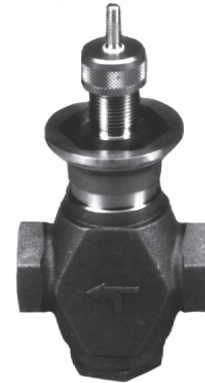

VG7000 Series Bronze Control Valve

Features

- size ranges of 1/2 in. through 2 in. with several styles of electric and pneumatic actuators offer a broad selection
- American National Standards Institute (ANSI) Class 250 (pressure/temperature) standard compliant

Repair Information

If the VG7000 Series Globe Valve fails to operate within its specifications, replace the valve body, actuator, or entire assembly. For replacement parts, contact the nearest Johnson Controls representative.

Selection Charts

VG7000 Series Valve Bodies

Valve Size, in.	Cv	End Connections ¹						
		National Pipe Thread (NPT)	Union Sweat	Union Sweat (3/8 in. Copper Tubing)	Union Sweat (3/4 in. Copper Tubing)	Union Globe	Union Angle	NPT
Two-Way Push-Down-to-Close								
Brass Trim								Stainless Steel Trim
1/2	0.73	VG7241CT	VG7281CT	VG7271CT	VG7291CT	VG7251CT	VG7551CT	VG7243CT
1/2	1.8	VG7241ET	VG7281ET	VG7271ET	VG7291ET	VG7251ET	VG7551ET	VG7243ET
1/2	4.6	VG7241GT	VG7281GT	VG7271GT	VG7291GT	VG7251GT	VG7551GT	VG7243GT
3/4	7.3	VG7241LT	VG7281LT	—	—	VG7251LT	VG7551LT	VG7243LT
1	11.6	VG7241NT	VG7281NT	—	—	VG7251NT	VG7551NT	VG7243NT
1-1/4	18.5	VG7241PT	VG7281PT	—	—	VG7251PT	VG7551PT	VG7243PT
1-1/2	28.9	VG7241RT	VG7281RT	—	—	VG7251RT	VG7551RT	VG7243RT
2	46.2	VG7241ST	VG7281ST	—	—	—	—	VG7243ST
1-1/2	28.9	3/8 in. M Stem Only Available in 1-1/2 and 2 in. NPT Stainless Steel Trim						VG7243RM
2	46.2							VG7243SM
Two-Way Push-Down-to-Open								
Brass Trim								Stainless Steel Trim
1/2	0.73	VG7441CT	VG7481CT	VG7471CT	VG7491CT	VG7451CT	—	VG7443CT
1/2	1.8	VG7441ET	VG7481ET	VG7471ET	VG7491ET	VG7451ET	—	VG7443ET
1/2	4.6	VG7441GT	VG7481GT	VG7471GT	VG7491GT	VG7451GT	—	VG7443GT
3/4	7.3	VG7441LT	VG7481LT	—	—	—	—	VG7443LT
1	11.6	VG7441NT	VG7481NT	—	—	—	—	VG7443NT
1-1/4	18.5	VG7441PT	VG7481PT	—	—	—	—	VG7443PT
1-1/2	28.9	VG7441RT	VG7481RT	—	—	—	—	VG7443RT
2	46.2	VG7441ST	VG7481ST	—	—	—	—	VG7443ST
1-1/2	28.9	3/8 in. M Stem Only Available in 1-1/2 and 2 in. NPT Stainless Steel Trim						VG7443RM
2	46.2							VG7443SM
Three-Way Mixing								
Brass Trim								Stainless Steel Trim
1/2	0.73	VG7842CT	VG7882CT	VG7872CT	VG7892CT	—	—	VG7844CT
1/2	1.8	VG7842ET	VG7882ET	VG7872ET	VG7892ET	—	—	VG7844ET
1/2	4.6	VG7842GT	VG7882GT	VG7872GT	VG7892GT	—	—	VG7844GT
3/4	7.3	VG7842LT	VG7882LT	—	—	—	—	VG7844LT
1	11.6	VG7842NT	VG7882NT	—	—	—	—	VG7844NT
1-1/4	18.5	VG7842PT	VG7882PT	—	—	—	—	VG7844PT
1-1/2	28.9	VG7842RT	VG7882RT	—	—	—	—	VG7844RT
2	46.2	VG7842ST	VG7882ST	—	—	—	—	VG7844ST
1-1/2	28.9	3/8 in. M Stem Only Available in 1-1/2 and 2 in. NPT Stainless Steel Trim						VG7844RM
2	46.2							VG7844SM

1. All actuators except MP84 Series use the 1/4 in. T stem. MP84 Series pneumatic actuators require the 3/8 in. M stem.

VG7000 Series Bronze Globe Valves for Assembly in the Field (Continued)

Pneumatic Actuators for VG7000 Series Brass Trim Valve Bodies

Actuator Code Number	V-3801-8001			V-3000-8012 Exposed Spring			MP822C00 (3 to 7)	1 and 1-1/4 in.		
				V-3000-8003 Enclosed Spring ¹			MP822D00 (4 to 8) MP822E00 (9 to 13)			
Temperature Range	35°F to 248°F (2°C to 120°C), 15 psig Saturated Steam			35°F to 284°F (2°C to 140°C), 38 psig Saturated Steam			35°F to 284°F (2°C to 140°C), 38 psig Saturated Steam			
Spring Range	3 to 6	4 to 8	9 to 13	3 to 6	4 to 8	9 to 13	3 to 7	4 to 8	9 to 13	
Valve Size	Mounting Kit									
1/2 and 3/4 in.	VG7000-1010	VG7000-1011	VG7000-1012	VG7000-1001	VG7000-1002	VG7000-1003				
1 and 1-1/4 in.				VG7000-1004	VG7000-1005	VG7000-1006	MP8000-6702			
1-1/2 and 2 in.				VG7000-1007	VG7000-1008	VG7000-1009				
Positioner	Not Available			V-9502-90 (V-3000-8012 Only)			V-9502-95			
Size, in.	Cv	Closeoff Pressure, psig								
Two-Way Normally Open										
1/2	0.73	186	157	84	365	339	191			
1/2	1.8	186	157	84	365	339	191			
1/2	4.6	105	89	48	225	192	108			
3/4	7.3	67	56	30	144	122	69			
1	11.6				90	76	42	279	257	148
1-1/4	18.5				55	47	26	170	157	90
1-1/2	28.9				35	30	16	109	100	58
2	46.2				22	19	11	70	64	37
Two-Way Normally Closed										
1/2	0.73	37	57	158	100	142	348			
1/2	1.8	37	57	158	100	142	348			
1/2	4.6	18	28	76	49	68	168			
3/4	7.3	11	16	45	29	41	100			
1	11.6				17	25	65	70	96	223
1-1/4	18.5				10	14	37	40	55	128
1-1/2	28.9				6	9	23	25	34	79
2	46.2				4	6	14	16	21	50
Three-Way Mixing										
1/2	0.73	186/37	157/57	84/158	365/100	339/142	191/348			
1/2	1.8	186/37	157/57	84/158	365/100	339/142	191/348			
1/2	4.6	105/18	89/28	48/76	225/49	192/68	108/168			
3/4	7.3	67/11	56/16	30/45	144/29	122/41	69/100			
1	11.6				90/17	76/25	42/65	279/70	257/96	148/223
1-1/4	18.5				55/10	47/14	26/37	170/40	157/55	90/128
1-1/2	28.9				35/6	30/9	16/23	109/25	100/34	58/79
2	46.2				22/4	19/6	11/14	70/16	64/21	37/50

1. To prevent finger injury, V-3000-8003 actuators with enclosed springs are used in applications where the valve is exposed to the public. Typical applications include control of hot water or steam radiators.

VG7000 Series Bronze Globe Valves for Assembly in the Field (Continued)

Pneumatic Actuators for VG7000 Series Stainless Steel Trim Valve Bodies

Actuator Code Number	V-3000-8012 Exposed Spring			MP821C00 (3 to 7)	1/2 and 3/4 in.	MP843C00 (3 to 7)	1-1/2 and 2 in.			
	V-3000-8003 Enclosed Spring ¹			MP821D00 (4 to 8)	1 and 1-1/4 in.	MP843D00 (4 to 8)				
				MP821E00 (9 to 13)		1-1/2 and 2 in.		MP843E00 (9 to 13)		
				MP822C00 (3 to 7)						
			MP822D00 (4 to 8)							
			MP822E00 (9 to 13)							
			MP823C00 (3 to 7)							
			MP823D00 (4 to 8)							
			MP823E00 (9 to 13)							
Temperature Range	35°F to 338°F (2°C to 170°C), 100 psig Saturated Steam			35°F to 338°F (2°C to 170°C), 100 psig Saturated Steam			35°F to 338°F (2°C to 170°C), 100 psig Saturated Steam			
Spring Range	3 to 6	4 to 8	9 to 13	3 to 6	4 to 8	9 to 13	3 to 7 4 to 8 9 to 13			
Valve Size	Mounting Kit									
1/2 and 3/4 in.	VG7000-1001	VG7000-1002	VG7000-1003	MP8000-6701			Not Recommended			
1 and 1-1/4 in.	VG7000-1004	VG7000-1005	VG7000-1006	MP8000-6702						
1-1/2 and 2 in.	VG7000-1007	VG7000-1008	VG7000-1009				MP8000-6703			
Positioner	V-9502-90 (V-3000-8012 Only)			V-9502-95			V-9502-95			
Size, in.	Cv	Closeoff Pressure, psig								
Two-Way Normally Open										
1/2	0.73	299	255	143	308	308	308			
1/2	1.8	299	255	143	308	308	308			
1/2	4.6	169	144	81	308	308	275			
3/4	7.3	108	92	52	304	304	175			
1	11.6	67	57	32	209	193	111			
1-1/4	18.5	41	35	19	128	118	68			
1-1/2	28.9				82	75	43	165	152	88
2	46.2				52	48	28	106	97	56
Two-Way Normally Closed										
1/2	0.73	75	106	261	280	308	308			
1/2	1.8	75	106	261	280	308	308			
1/2	4.6	36	51	126	135	183	308			
3/4	7.3	22	31	75	81	109	252			
1	11.6	13	19	49	53	72	168			
1-1/4	18.5	7	11	28	30	41	96			
1-1/2	28.9				19	25	59	39	53	121
2	46.2				12	16	37	24	33	76
Three-Way Mixing										
1/2	0.73	299/75	255/106	143/261	308/280	308/308	308/308			
1/2	1.8	299/75	255/106	143/261	308/280	308/308	308/308			
1/2	4.6	169/36	144/51	81/126	308/135	308/183	275/308			
3/4	7.3	108/22	92/31	52/75	304/81	304/109	175/252			
1	11.6	67/13	57/19	32/49	209/53	193/72	111/168			
1-1/4	18.5	41/7	35/11	19/28	128/30	118/41	68/96			
1-1/2	28.9				82/19	75/25	43/59	165/39	152/53	88/121
2	46.2				52/12	48/16	28/37	106/24	97/33	56/76

1. To prevent finger injury, V-3000-8003 actuators with enclosed springs are used in applications where the valve is exposed to the public. Typical applications include control of hot water or steam radiators.

VG7000 Series Bronze Globe Valves for Assembly in the Field (Continued)

Non-Spring-Return Electric Actuators for VG7000 Series Valve Bodies

Actuator Code Number	VA-7150-1001 On/Off (Floating)		VA-7200-1001 On/Off (Floating)		VA7810-AGA-2 On/Off (Floating Control) VA7810-AGC-2 On/Off (Floating Control) with Two Switches		
	VA-7152-1001 0 to 10 VDC Proportional		VA-7202-1001 0 to 10 VDC Proportional		VA7810-HGA-2 0 to 10 VDC Proportional Control VA7810-HGC-2 0 to 10 VDC Proportional Control with Two Switches		
	VA-7153-1001 On/Off (Floating) with Feedback		VA-7203-1001 On/Off (Floating) with Feedback				
Temperature Range	Brass Trim: 35°F to 284°F (2°C to 140°C), 38 psig Saturated Steam Stainless Steel: 35°F to 338°F (2°C to 170°C), 100 psig Saturated Steam						
Linkage	None						
Stem Type	Requires T Stem						
Size, in.	Cv	Closeoff Pressure, psig					
		Brass Trim	Stainless Steel Trim	Brass Trim	Stainless Steel Trim	Brass Trim	Stainless Steel Trim
Two-Way Normally Open							
1/2	0.73	345	239		308		308
1/2	1.8	345	239		308		308
1/2	4.6	216	135		278		283
3/4	7.3	138	86		177		180
1	11.6	86	54	179	112	182	114
1-1/4	18.5	52	33	109	68	111	70
1-1/2	28.9	34	21	70	44	71	45
2	46.2	21	13	45	28	46	28
Two-Way Normally Closed							
1/2	0.73	345	308		308		308
1/2	1.8	345	308		308		308
1/2	4.6	257	161		308		308
3/4	7.3	153	96		197		201
1	11.6	100	63	209	131	213	133
1-1/4	18.5	57	36	120	75	122	76
1-1/2	28.9	36	22	74	46	76	47
2	46.2	22	14	46	29	47	30
Three-Way Mixing							
1/2	0.73	345/345	239/308		308/308		308/308
1/2	1.8	345/345	239/308		308/308		308/308
1/2	4.6	216/257	135/161		278/308		283/308
3/4	7.3	138/153	86/96		177/197		180/201
1	11.6	86/100	54/63	179/209	112/131	182/213	114/133
1-1/4	18.5	52/57	33/36	109/120	68/75	111/122	70/76
1-1/2	28.9	34/36	21/22	70/74	44/46	71/76	45/47
2	46.2	21/22	13/14	45/46	28/29	46/47	28/30

The performance specifications are nominal and conform to acceptable industry standards. For applications at conditions beyond these specifications, consult the local Johnson Controls office. Johnson Controls shall not be liable for damages resulting from misapplication or misuse of its products. © 2019 Johnson Controls. www.johnsoncontrols.com

VG7000 Series Bronze Globe Valves for Assembly in the Field (Continued)

Spring-Return Electric Actuators for VG7000 Series Valve Bodies

Actuator Code Number	VA-4233-AGA-2 Floating Control		VA7820-HGA-2 ¹ 0 to 10 VDC Proportional Control		VA7830-HGA-2 ¹ 0 to 10 VDC Proportional Control		
	VA-4233-AGC-2 Floating Control with Two Switches		VA7820-HGC-2 ¹ 0 to 10 VDC Proportional Control with Two Switches		VA7830-HGC-2 ¹ 0 to 10 VDC Proportional Control with Two Switches		
	VA-4233-BGA-2 On/Off Control						
	VA-4233-BGC-2 On/Off Control with Two Switches						
	VA-4233-GGA-2 0 to 10 VDC Proportional Control						
	VA-4233-GGC-2 0 to 10 VDC Proportional Control with Two Switches						
	Spring-Return Valve Stem Up		Spring-Return Valve Stem Up		Spring-Return Valve Stem Down		
Temperature Range	Brass Trim: 35°F to 284°F (2°C to 140°C), 38 psig Saturated Steam						
	Stainless Steel: 35°F to 338°F (2°C to 170°C), 100 psig Saturated Steam						
Linkage	None						
Stem Type	Requires T Stem						
Size, in.	Cv	Closeoff Pressure					
		Brass Trim	Stainless Steel Trim	Brass Trim	Stainless Steel Trim	Brass Trim	Stainless Steel Trim
Two-Way Normally Open							
1/2	0.73	345	230	—	308	—	308
1/2	1.8	345	230	—	308	—	308
1/2	4.6	208	130	—	283	—	283
3/4	7.3	132	82	—	180	—	180
1	11.6	63	39	182	114	182	114
1-1/4	18.5	38	24	111	70	111	70
1-1/2	28.9			71	45	71	45
2	46.2			46	28	46	28
Two-Way Normally Closed							
1/2	0.73	345	224	—	308	—	308
1/2	1.8	345	224	—	308	—	308
1/2	4.6	173	108	—	308	—	308
3/4	7.3	103	64	—	201	—	201
1	11.6	66	41	213	133	213	133
1-1/4	18.5	38	24	122	76	122	76
1-1/2	28.9			76	47	76	47
2	46.2			47	30	47	30
Three-Way Mixing							
1/2	0.73	345/345	230/224	—	308/308	—	308/308
1/2	1.8	345/345	230/224	—	308/308	—	308/308
1/2	4.6	208/173	130/108	—	283/308	—	283/308
3/4	7.3	132/103	82/64	—	180/201	—	180/201
1	11.6	63/66	39/41	182/213	114/133	182/213	114/133
1-1/4	18.5	38/38	24/24	111/122	70/76	111/122	70/76
1-1/2	28.9			71/76	45/47	71/76	45/47
2	46.2			46/47	28/30	46/47	28/30

1. VA7820 and VA7830 spring-return actuators ship from the factory already set for 0-10 VDC proportional control. These actuators have field-selectable switches that allow the actuators to be used for on/off control or three-wire floating control.

VG7000 Series Bronze Globe Valves for Assembly in the Field (Continued)

Technical Specifications

VG7000 Series Bronze Globe Valves for Assembly in the Field				
Service¹		Hot Water, and Chilled Water, and Steam with up to 50% Glycol Solution		
		Cv		
Valve Body Sizes Available	1/2 in. (DN15)	0.73, 1.8, 4.6		
	3/4 in. (DN20)	7.3		
	1 in. (DN25)	11.6		
	1-1/4 in. (DN32)	18.5		
	1-1/2 in. (DN40)	28.9		
	2 in. (DN50)	46.2		
Stem Travel	Two-Way and Three-Way	1/2 in. and 3/4 in. Valves	1 in. and 1-1/4 in. Valve	1-1/2 in. and 2 in. Valves
		5/16 in.	1/2 in.	3/4 in.
		Brass Trim		Stainless Steel Trim
End Connections		NPT, Union Sweat, Globe and Angle		NPT
Materials	Body	Cast Bronze – C84400		Cast Bronze – C83600
	Stem	Stainless Steel		Stainless Steel
	Plug	Brass		Stainless Steel
	Seat	3/4 in. through 2 in.: Machined from Body 1/2 in.: Brass Seat		Stainless Steel Replaceable Seat
	Disk	Ethylene Propylene Diene Monomer (EPDM)		Stainless Steel
	Packing	Self-Adjusting Ethylene Propylene Terpolymer (EPT) U-Cups		Spring-Loaded Polytetrafluoroethylene (PTFE)
Flow Characteristic	Two-Way	Equal Percentage		Equal Percentage
	Three-Way	Linear		Linear
Ratings	Body	ANSI Class 250 ²		ANSI Class 250 ³
	Leakage (Percent of Maximum Flow)	0.01%		0.05%
	Fluid Temperature, Body Only⁴	35°F to 284°F (2°C to 140°C)		35°F to 338°F (2°C to 170°C)
	Maximum Steam Pressure, Saturated Steam	38 psig (262 kPa)		100 psig (690 kPa)
	Maximum Pressure Drop, Valve Open	35 psig (1/2 in. through 1-1/4 in.) 30 psig (1-1/2 in. and 2 in. Valves)		35 psig (1/2 in. through 1-1/4 in.) 30 psig (1-1/2 in. and 2 in. Valves)
Compliance	Canada	CRN: 0C1099.9087YTN		

1. Refer to the VDI 2035 Guideline for recommended proper water treatment.
2. 400 psig (2,758 kPa) for fluid temperatures between 35 and 150°F (2 and 66°C); decreasing to 365 psig (2,515 kPa) at 248°F (120°C).
3. 400 psig (2,758 kPa) for fluid temperatures between 35 and 150°F (2 and 66°C); decreasing to 308 psig (2,122 kPa) at 338°F (170°C).
4. Refer to appropriate actuator literature for ambient limitations due to the actuator.



This product is made of copper alloy, which contains lead. The product is therefore not to be used on drinking water.



This product can expose you to chemicals including lead, which is known to the State of California to cause cancer, birth defects, or other reproductive harm. For more information, go to www.P65Warnings.ca.gov.

WARNING: BRASS MAY CONTAIN LEAD

To fulfill our obligations towards Article 33, in accordance to the European REACH Regulation No 1907/2006 EC, we hereby inform you that this article contains the following Substances of Very High Concern mentioned on the Candidate list:

- Lead

VA-715x Series Electric Valve Actuator

Description

The VA-715x Series synchronous, motor-driven actuator provides incremental (three-wire), incremental with feedback, or proportional control of valves with up to 3/4 in. (19.05 mm) stroke in HVAC applications.

This compact, non-spring-return actuator has a 90 lb (400 N) force minimum, and responds to a variety of input signals.

The VA-715x Series can be easily field mounted or ordered factory coupled to VG7000 Series Bronze Control Valves.

Refer to the *VG7000 Series Bronze Control Valves Product Bulletin (LIT-977140)* for important product application information.

Selection Chart

Code Number	Description
VA-7150-1001	Three-Wire Incremental
VA-7153-1001	Three-Wire Incremental with Position Feedback
VA-7152-1001	Proportional, 0 VDC to 10 VDC

Accessories

Code Number	Description
V-9999-670	Bonnet Adaptor (Used for Field Mounting to VT Series Valve Body with Threaded Stem)
Y20EBE-2	Adaptor Kit (Used for Field Mounting to VT Series Valve Body with Slotted Stem)
VA-7150-1900	Conduit Adaptor Kit
V-9999-HW1	Mounting Kit to Mount VA-715x or VA-720x Series Electric Actuators to Honeywell® V75011A, F, G, 1/2 in. through 3 in. Single-Seated and V5013F Three-Way Valves
V-9999-BC1	Mounting Kit to Mount VA-715x or VA-720x Series Electric Actuators to Barber-Colman® 1/2 in. through 1-1/4 in. VB-9xxx Valve Bodies

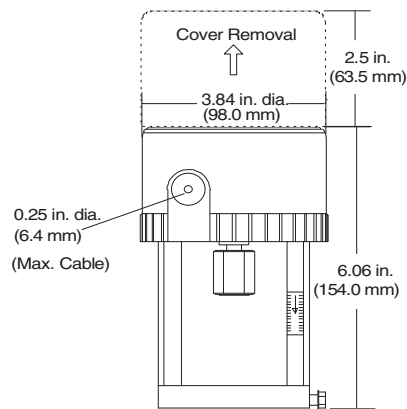

Dimensions, in. (mm)

Features

- magnetic clutch provides constant output force for positive closeoff of valves, and protects the motor in stall conditions
- selectable direct and reverse action simplifies setup and installation
- durable construction provides a longer cycle life
- compact unit provides 90 lb force output, covering a wide range of applications with just one actuator
- unique yoke design enables easy field mounting to valves, reducing installation and stroke adjustment time

Applications

The VA-715x Series Actuator is used in conjunction with VG7000 Series Valves for hot water and chilled water systems. For VG7000 Series Valve options, refer to the *VG7000 Series Brass Trim Globe Valves with VA-715x Series Electric Actuators Catalog Page (LIT-1900084)* and the *VG7000 Series Stainless Steel Trim Globe Valves with VA-715x Series Electric Actuators Catalog Page (LIT-1900090)*. For field mounting options, refer to the *VG7000 Series Bronze Globe Valves for Assembly in the Field Catalog Page (LIT-1924005)*.



VA-715x Electric Valve Actuator

Repair Information

If the VA-715x Series Electric Valve Actuator fails to operate within its specifications, replace the unit. For a replacement actuator, contact the nearest Johnson Controls® representative.

Technical Specifications

VA-715x Series Electric Valve Actuator	
Power Requirements	24 VAC (20 VAC to 30 VAC), 50/60 Hz
Input Signal	Incremental: 24 VAC, 50/60 Hz Incremental with Position Feedback: 24 VAC, 50/60 Hz Proportional: 0 VDC to 10 VDC
Input Signal Adjustments (Proportional)	Input Signal: 0 VDC to 5 VDC, 5 VDC to 10 VDC, 0 VDC to 10 VDC (Jumper Selectable) Action: Drive Up (RA) or Drive Down (DA) on Signal Increase (Jumper Selectable) Factory Setting: 0 VDC to 10 VDC Over 3/4 in. (19 mm) Stroke, DA
Input Impedance (Proportional)	100,000 Ohms
Feedback Signal	Proportional: 0 to 2,000 Ohms ±25%, 1/4 W, Over 25/32 in. (20 mm) Stroke
Mechanical Output	90 lb Force (400 N) Minimum
Stroke Range	5/16 in. to 25/32 in. (8 mm to 20 mm)
Nominal Stroke Timing	50 Hz: 85 Seconds 5/16 in. (8 mm) Stroke 135 Seconds 1/2 in. (13 mm) Stroke 200 Seconds 3/4 in. (19 mm) Stroke 60 Hz: 70 Seconds 5/16 in. (8 mm) Stroke 110 Seconds 1/2 in. (13 mm) Stroke 165 Seconds 3/4 in. (19 mm) Stroke
Media Temperature	280°F (138°C) Maximum
Electrical Connection	Screw Terminals for 16 AWG Maximum
Mechanical Connection	For 1/4 - 28 UNF Valve Stem
Enclosure	NEMA 2, IP42
Ambient Conditions	Operating: 0°F to 140°F (-18°C to 60°C); 10% to 90% RH Noncondensing 86°F (30°C) Maximum Dew Point Storage: -4°F to 150°F (-20°C to 65°C); 5% to 90% RH, 86°F (30°C) Maximum Dew Point
Agency Listings	UL 873 Listed, File E27734 CSA C22.2 No. 139 Certified, File LR85083

VA-748x Electric Valve Actuators

Description

VA-748x Series Electric Valve Actuators provide floating or proportional control in HVAC applications. The compact design of this actuator series makes it ideal for installations in confined locations, such as fan coil applications.

The VA-748x Series Actuator is designed for field mounting onto the terminal unit valves made by Johnson Controls and its competitors. Due to the innovative concept of auto stroke detection, the VA-748x actuator can be installed over most of the conventional terminal unit valves in the market and pressure independent control valves with variable strokes.

Refer to the *VA-748x Electric Valve Actuator Product Bulletin (LIT-12011893)* for important product application information.

Features

Selection Chart

Code Number	Power Supply	Control Type	Actuator Speed	Mounting Thread Nut	Cable Length (Factory Mounted)
VA-7480-0312	24 VAC	Floating	13 s/mm	M28 x 1.5	118 in. (3 m)
VA-7482-0312	24 VAC/VDC	Proportional	8 s/mm	M28 x 1.5	118 in. (3 m)
VA-7482-8002-RA	24 VAC/VDC	Proportional	8 s/mm	M30 x 1.5	59 in. (1.5 m)
VA-7482-9002-RA	24 VAC/VDC	Proportional	8 s/mm	M30 x 1.5	59 in. (1.5 m)

- Auto-commissioning simplifies installation, since models require no adjustments in the field
- Auto-shutoff actuator motor extends actuator life by reducing drive time and excessive motor wear
- Durable, heat-stabilized, plastic resin enclosure allows the actuator to be used in applications with fluid temperatures up to 203°F (95°C)
- Actuator can be mounted after the valve body is piped, simplifying installation and providing application flexibility
- Compact design allows for installation in confined locations, such as fan coil applications
- Operating status LED provides direct, visual indication of the actuator operating status
- Actuator can be rotated after it is mounted on the valve body, simplifying installation by allowing the actuator wiring entry to be located in any direction



VA-7480 Electric Valve Actuator

Repair Information

If the VA-748x Electric Actuator fails to operate within its specifications, replace the unit. For a replacement VA-748x Electric Valve Actuator, contact the nearest Johnson Controls® representative.

Technical Specifications

VA-748x Series Electric Valve Actuators		
Power Requirements	VA-7480-0312	24 VAC ±15% at 50/60 Hz; 2.5 VA at maximum power supply; Class 2
	VA-7482-xxx2	24 VAC ±15% at 50/60 Hz; 24 VDC ±15% at 2.5 VA at maximum power supply; Class 2
Input Signal	VA-7480-0312	24 VAC, 50/60 Hz
	VA-7482-xxx2	0 VDC to 10 VDC
Input Signal Adjustments	VA-7480-0312	None
	VA-7482-xxx2	Input Signal: 0 VDC to 10 VDC, 2 VDC to 10 VDC, 0 VDC to 5 VDC, 5 VDC to 10 VDC, 0 mA to 20 mA, or 4 mA to 20 mA Direction: Direct (drive down) or reverse (drive up) with input signal increase
Input Impedance	VA-7480-0312	3,900 ohms
	VA-7482-xxx2	100,000 ohms
Electrical Connections	VA-7480-0312	18 AWG cable; 118 in. (3 m) long
	VA-7482-0312	
	VA-7482-8002-RA	18 AWG cable; 59 in. (1.5 m) long
	VA-7482-9002-RA	
Mechanical Connections	Threaded coupling for Johnson Controls VG4000, VG5000, M28x1, and M28x5 Series Zone Valves Threaded coupling for Johnson Controls VG6000, V5000, VP100, M30x1, and M30x5 Series Zone Valves	
Protection	NEMA 2, IP43	
Output Force	VA-7480-0312	21.5 lb (96 N) minimum
	VA-7482-0312	
	VA-7482-8002-RA VA-7482-9002-RA	31.4 lb (140 N) minimum
Mechanical Stroke	0.25 in. (6.3 mm) maximum	
Full Stroke Cycle Time	Floating 13 s/mm, proportional 8 s/mm	
Full Stroke Cycles	VA-7480-0312	250,000
	VA-7482-0312	
	VA-7482-8002-RA	150,000
	VA-7482-9002-RA	
Audible Noise Rating	<30 dBA	
Fluid Temperature Limits	35°F to 203°F (2°C to 95°C)	
Ambient Operating Conditions	32°F to 122°F (0°C to 50°C), noncondensing	

The performance specifications are nominal and conform to acceptable industry standards. For applications at conditions beyond these specifications, consult the local Johnson Controls office. Johnson Controls shall not be liable for damages resulting from misapplication or misuse of its products. © 2019 Johnson Controls www.johnsoncontrols.com

VA-748x Electric Valve Actuators (Continued)

VA-748x Series Electric Valve Actuators		
Ambient Storage Conditions		-4°F to 149°F (-20°C to 65°C), noncondensing
Compliance	United States	Tested per UL2043. Suitable for Use in Other Environmental Air Space (Plenums) in Accordance with Section 300.22 (C) of the National Electrical Code. UL 60730-1 Listed Type 2 Enclosure, File E194024 XAPX XAPX7
	Canada	CSA C22.2 No. 139 Certified, File LR85083, Class 3221 01
	Europe	CE Mark – Johnson Controls declares that this product is in compliance with the essential requirements and other relevant provisions of the EMC Directive 2004/108/EC and Low Voltage Directive 2006/95/EC.

VA-4233 Series Electric Valve Actuators

Description

VA-4233 Series Electric Valve Actuators use a stepper motor to accurately position control valves in HVAC applications. In the event of a power failure, a spring in the actuator automatically returns the valve to the full stem-up position. These direct-mount, spring-return electric actuators provide a minimum 61 lb (271 N) force output for floating, on/off, or proportional control, and can be easily field mounted or ordered factory coupled to Johnson Controls® 1/2 in. through 1-1/4 in. VG7000 Series Bronze Control Valves, with no additional linkages required.

The VA-4233 Series can also be field mounted to select Barber-Colman® valves, using mounting kits available from Johnson Controls. Proportional control models include an AUTO stroke calibration feature that eliminates the need for manual calibration or adjustment after installation. Integral auxiliary switches are available to indicate end-stop position or to perform switching functions. On proportional models, position feedback is also available through a proportional DC voltage signal. All models feature a hand crank for manual positioning of the valve, independent of a power supply.

Refer to the *VA-4233 Series Electric Valve Actuators Product Bulletin (LIT-977552)* for important product application information.

Features

- designed for use in hot water, chilled water, and steam applications, allowing for universal application
- automatic spring return returns the valve to the full stem-up position, in the event of a power failure
- simple no-linkage mounting with AUTO stroke calibration at installation (VA-4233-GGx models only) reduces installation time and cost
- reversible stroke direction (VA-4233-GGx models only) expands usability by allowing switch-selectable direct or reverse action
- optional auxiliary switches provide adjustable switch points with line voltage capability
- 0 (2) VDC to 10 VDC, 6 VDC to 9 VDC, or 0 (4) mA to 20 mA input (VA-4233-GGx models only) provides enhanced control solutions
- optional power supply output of 20 VDC at 25 mA (VA-4233-GGx models only) provides power for external devices, making the VA-4233-GGx an ideal replacement for Barber-Colman retrofit installations
- manual hand crank allows for manual positioning of the valve, independent of a power supply

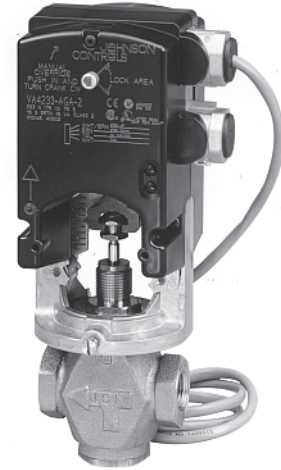

VA-4233 Series Electric Valve Actuator Mounted on a VG7000 Series Bronze Control Valve

- integral position indicator provides visual indication of the valve stem position
- 1/2 in. conduit connector with 48 in. wire leads meets national and local code requirements for wiring, and allows easy field wiring on retrofit jobs

Selection Chart

Description	Actuator Model						
	VA-4233-AGA-2	VA-4233-AGC-2	VA-4233-BGA-2	VA-4233-BGC-2	VA-4233-GGA-2	VA-4233-GGA-2MP	VA-4233-GGC-2
Floating Control	■	■	—	—	—	—	—
On/Off Control	—	—	■	■	—	—	—
Proportional Control	—	—	—	—	■	■	■
Feedback:							
0 (2) VDC to 10 VDC or 6 VDC to 9 VDC at 2 mA	—	—	—	—	■	■	■
Two Auxiliary Switches	—	■	—	■	—	—	■
Power Supply Output of 20 VDC at 25 mA	—	—	—	—	—	■	—
Automatic Spring Return (Returns Valve to Full Stem-Up Position)	■	■	■	■	■	■	■

Accessories

Code Number	Description
M9000-200	Commissioning Tool (Used when AUTO Stroke Calibrating a VA-4233-GGx Series Electric Valve Actuator Prior to Initial Installation)
VG7000-1016	Bonnet Adaptor (Used when Replacing Johnson Controls M100, V-400, V-500, and MP8000 Series Valve Actuators on VG7000 Series Bronze Control Valves)
V-9999-BC1	Mounting Kit (Used when Mounting a VA-4233-GGx Series Electric Valve Actuator onto a 1/2 in. through 1-1/4 in. Barber-Colman VB-7xxx Series Valve)

Repair Parts

Code Number	Description
VA-4233-600	Manual Hand Crank Kit (Includes Five Manual Hand Cranks)
VA-4233-601 ¹	Hardware Kit (Includes One Manual Hand Crank, One Special Stem Nut, One Jam Nut, and One Yoke Screw)

1. Items included in the hardware kit are also included with each actuator.

VA-4233 Series Electric Valve Actuators (Continued)

Technical Specifications

VA-4233 Series Electric Valve Actuators		
Control Type	VA-4233-AGx Models	Floating Control
	VA-4233-BGx Models	On/Off Control
	VA-4233-GGx Models	Proportional Control
Force Output	Minimum 61 lb (271 N)	
Power Requirements	20 VAC to 30 VAC at 50/60 Hz or 24 VDC \pm 10%; Class 2, 12 VA	
Input Signal	VA-4233-AGx Models	20 VAC to 30 VAC at 50/60 Hz or 24 VDC \pm 10%, 2 mA
	VA-4233-BGx Models	20 VAC to 30 VAC at 50/60 Hz or 24 VDC \pm 10%, 12 VA
	VA-4233-GGx Models	0 (2) VDC to 10 VDC, 6 VDC to 9 VDC, or 0 (4) mA to 20 mA
Input Signal Adjustments (VA-4233-GGx Models Only)	Factory Set at 0 VDC to 10 VDC; Switch Selectable 0 (2) VDC to 10 VDC, 6 VDC to 9 VDC, or 0 (4) mA to 20 mA	
Direction of Action (VA-4233-GGx Models Only)	Switch Selectable Stem Up or Stem Down with Signal Increase	
Input Impedance (VA-4233-GGx Models Only)	Voltage Input	200,000 Ohms
	Current Input	500 Ohms
Feedback Signal (VA-4233-GGx Models Only)	0 VDC to 10 VDC, 2 VDC to 10 VDC, or 6 VDC to 9 VDC at 2 mA (Corresponding to Input Signal Selection)	
Switch Contact Rating (VA-4233-xGC-2 and -2MP Models Only)	Two Single-Pole, Double-Throw (SPDT), Double Insulated Switches: 24 VAC, 50 VA Pilot Duty; 120 VAC, 5.8 A Resistive, 1/4 hp, 275 VA Pilot Duty; 240 VAC, 2.9 A Resistive, 1/4 hp, 275 VA Pilot Duty	
Maximum Stroke	29/32 in. (23 mm)	
Nominal Timing for 29/32 in. Stroke	76 Seconds (Proportionally Less for Shorter Strokes)	
Nominal Spring Return Timing for 29/32 in. Stroke	4 to 9 Seconds at Room Temperature (Proportionally Less for Shorter Strokes)	
Spring Return Direction	Stem Up	
Electrical Connections	Actuator	48 in. (122 cm) Cable with 20 AWG Wire Leads
	Auxiliary Switches (VA-4233-xGC-2 and -2MP Models Only)	48 in. (122 cm) Cable with 18 AWG Wire Leads
Ambient Temperature Limits	Operating	32°F to 122°F (0°C to 50°C)
	Storage	-85°F to 185°F (-65°C to 85°C)
Maximum Ambient Humidity Limits	95% RH Noncondensing (90% RH at 70°F Ambient Temperature and 40°F Fluid Temperature)	
Fluid Temperature Limits (Actuator and Valve Assembly)	35°F to 250°F (2°C to 121°C); 15 psig (103 kPa) Saturated Steam	
Acoustic Noise	35 dB(A) Maximum at 39 in. (100 cm) per DIN 1946 and ISO 3745	
Agency Compliance	UL 873 Listed, File E27734, CCN XAPX; CSA C22.2 No. 139 Certified, File LR85083, Class 3221 02	
Enclosure Rating	NEMA 2, IP 42	
Shipping Weight	3.1 lb (1.4 kg)	

VA-720x Series Electric Valve Actuator

Description

The VA-720x Series Electric Actuator provides incremental or proportional control of valves with up to a 3/4 in. (19.05 mm) stroke in HVAC applications.

The VA-720x is a non-spring-return, synchronous, motor-driven electric actuator featuring a 180 lb (800 N) minimum seating force in a compact, easy-to-install package. It accepts incremental control from a three-wire 24 VAC control signal or a proportional DC control signal (up to 10 V maximum). The VA-7203 also contains a 2,000 ohm position feedback potentiometer.

The VA-720x Series can be easily field mounted to VBC Series Bronze Cage Trim Valves and factory or field mounted to VG7000 Series Bronze Control Valves.

Refer to the *VG7000 Series Bronze Control Valves Product Bulletin (LIT-977140)* for important product application information.

Features

- compact unit provides 180 lb force (800 N) output covering a wide range of applications with just one actuator
- magnetic clutch provides constant output force for positive closeoff of valves and protects motor in stall conditions
- durable construction provides longer cycle life
- unique yoke design enables easy field mounting to valves, reducing installation and stroke adjustment time
- selectable direct and reverse action simplifies setup and installation
- built-in resistor for current control provides greater application flexibility



VA-720x Electric Valve Actuator

Selection Chart

Code Number	Description
VA-7200-1001	Three-Wire Incremental
VA-7203-1001	Three-Wire Incremental with Position Feedback
VA-7202-1001	Proportional: 0 VDC to 10 VDC; 0 mA to 20 mA

Accessories

Code Number	Description
V-9999-HW1	Mounting Kit to Mount VA-715x or VA-720x Series Electric Actuators to Honeywell® V75011A, F, G, 1/2 through 3 in. Single-Seated and V5013F Three-Way Valves
V-9999-BC1	Mounting Kit to Mount VA-715x or VA-720x Series Electric Actuators to Barber-Colman® 1/2 in. through 1-1/4 in. VB-9xxx Valve Bodies
VG7000-1016	Bonnet Adaptor for VA7200 Series Electric Actuator on 1 in. to 2 in. VG7000 Series Valves

Applications

The VA-720x Series Actuator is used in conjunction with VG7000, VT, Flare, and Bronze Cage Trim Valves for hot-water and chilled-water systems. For VG7000 Series Valve factory mounted options, refer to the *VG7000 Series Brass Trim Globe Valves with VA720x Series Electric Actuators Catalog Page (LIT-1900085)* and the *VG7000 Series Stainless Steel Trim Globe Valves with VA-720x Series Electric Actuators Catalog Page (LIT-1900091)*.

For field mounting options, refer to the *VG7000 Series Bronze Globe Valves for Assembly in the Field Catalog Page (LIT-1924005)*.

Repair Information

If the VA-720x Series Electric Actuator fails to operate within its specifications, replace the unit. For a replacement actuator, contact the nearest Johnson Controls® representative.

Technical Specifications

VA-720x Series Electric Valve Actuator	
Power Requirements	24 VAC (20 VAC to 30 VAC), 50/60 Hz
Input Signal	Incremental: 24 VAC, 50/60 Hz Proportional: 0 VDC to 10 VDC or 0 mA to 20 mA (Jumper Selectable)
Input Signal Adjustments (Proportional)	Offset: Adjustable 0 VDC to 8 VDC / 0 mA to 16 mA Span: 2 VDC to 10 VDC or 4 mA to 20 mA Action: Drive Up (DA) or Drive Down (DA) on Signal Increase Factory Setting: 0 VDC to 10 VDC, Drive Up (DA), 3/4 in. (19 mm) Stroke
Input Impedance (Proportional)	Voltage: 100,000 Ohms Current: 500 Ohms
Feedback Signal	Proportional: 0 to 2,000 Ohms ± 25%, 1/4 W, Over 25/32 in. (20 mm) Stroke
Mechanical Output	180 lb Force (800 N) Minimum
Stroke Range	25/32 in. (20 mm) Maximum
Nominal Stroke Timing	50 Hz: 50 Seconds 1/2 in. (13 mm) Stroke 74 Seconds 3/4 in. (19 mm) Stroke 60 Hz: 42 Seconds 1/2 in. (13 mm) Stroke 62 Seconds 3/4 in. (19 mm) Stroke
Media Temperature	280°F (138°C) Maximum
Electrical Connection	Screw Terminals: VA-7200: 24 to 14 AWG VA-7203: 24 to 16 AWG VA-7202: 24 to 16 AWG
Mechanical Connection	For 1/4 - 28 UNF-2B Thread for Valve Stem Connection
Enclosure	NEMA 2, IP42
Ambient Conditions	Operating: 23°F to 131°F (-5°C to 55°C), 5% to 90% RH Noncondensing 86°F (30°C) Maximum Dew Point Storage: -4°F to 150°F (-20°C to 65°C); 5% to 95% RH, 86°F (30°C) Maximum Dew Point
Agency Listings	UL 873 Listed, File E27734 CSA C22.2 No. 139 Certified, File LR850853

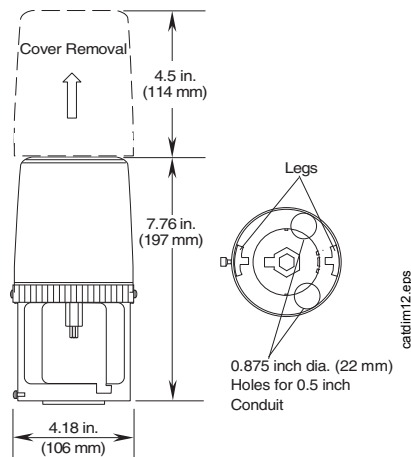

Dimensions, in. (mm)

VA-7700 Series Electric Non-Spring Return Actuators

Description

The VA-7700 Series Electric Non-Spring Return Actuators are synchronous motor-driven actuators for valves in HVAC applications. These compact actuators are available for floating or proportional control. The VA-7700 Series Electric Actuators provide a stroke capability of 3/8 in. (8 mm) to a maximum 3/4 in. (20 mm). They have a 90 lb (400 N) force minimum and respond to a variety of input signals.

The VA-7700 Series Electric Actuators can be combined with Johnson Controls® VG7000 and VB Series valves in accordance with the maximum close-off pressure ratings specified.

Refer to the *VA-7700 Series Electric Non-Spring Return Actuators Product Bulletin (LIT-12012122)* for important product application information.

Features

- self-adjusting proportional electric actuators allow for easy, quick, and precise commissioning and servicing

- column of five LEDs allows easy visualization of the electric actuator stroke position and status
- IP54 protection class allows for installation in a wide range of environments
- unique c-shaped yoke design allows for lateral mounting of the electric actuator, reducing the vertical space required over the valve for installation
- positioner with selectable zero and span adjustment and direct and reverse action modes enables sequence control
- magnetic clutch provides constant output force for closeoff of valves, and protects the motor in stall conditions
- signal failure position preset indicates a control signal failure in the electric actuator



VA-7700 Series Electric Non-Spring Return Actuator

Applications

The VA-7700 Series Electric Actuators are available for use with floating and proportional controllers.

Each electric actuator is installed directly on VG7000 Series threaded valves using a jam nut (included with the electric actuator).

Repair Information

If the VA-7700 Series Electric Non-Spring Return Actuator fails to operate within its specifications, replace the unit. For a replacement electric actuator, contact the nearest Johnson Controls® representative.

Selection Charts

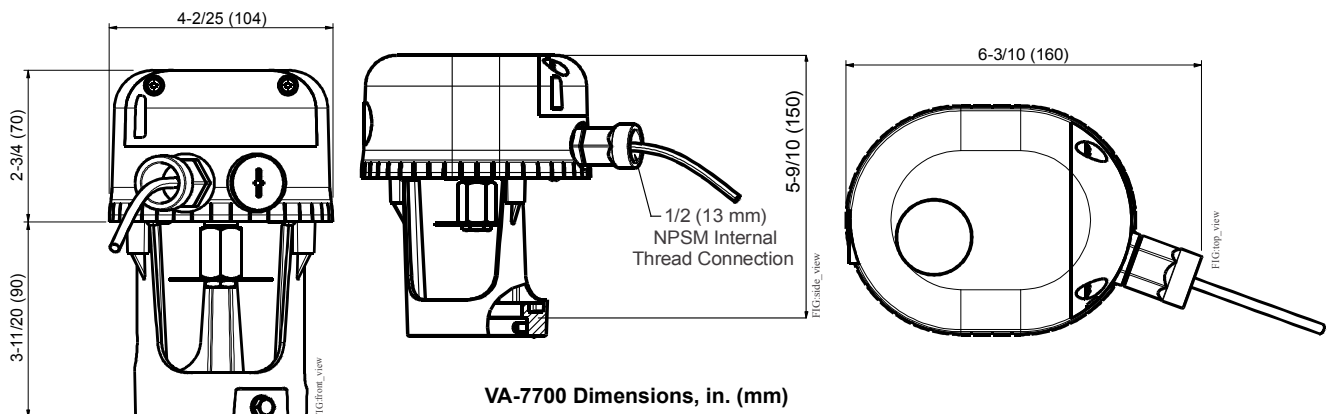

VA-7700 Series Electric Non-Spring Return Actuators

Code Number	Power Supply	Control Type	Manual Override	Valve Combination
VA-7700-AGA-2	24 VAC	Floating	No	VG7000 and VB Series
VA-7700-GGA-2	24 VAC	Proportional (0 to 10 VDC / 0(4) to 20 mA)	Electrical	VG7000 and VB Series



VA-7700 Series Electric Non-Spring Return Actuators (Continued)

Technical Specifications

VA-7700 Series Electric Non-Spring Return Actuators		
Product	VA-7700-AGA-2 Floating Model	VA-7700-GGA-2 Proportional Model
Power Requirement	24 VAC (20.4 VAC to 27.6 VAC) at 50/60 Hz: Class 2 (North America) or SELV (Europe), 3.2 VA running	24 VAC (20.4 VAC to 27.6 VAC) at 50/60 Hz: Class 2 (North America) or SELV (Europe), 4.3 VA running
Input Signal/Adjustments	N/A	0 VDC to 10 VDC 0(4) mA to 20 mA Adjustable zero and span
Control Input Impedance	N/A	0 VDC to 10 VDC: 100k Ohms
Feedback Signal	N/A	0 VDC to 10 VDC
Motor	Impedance protected motor	
Force Minimum	90 lb (400 N)	
Stroke Range	4/5 in. (20 mm) maximum	
Movement Type	Linear	
Stroke Time Normal	3/8 in. (8 mm) at 50 Hz: 84 seconds at 60 Hz: 70 seconds 1/2 in. (13 mm) at 50 Hz: 137 seconds at 60 Hz: 114 seconds 3/4 in. (19 mm) at 50 Hz: 200 seconds at 60 Hz: 167 seconds	
Cycles	250,000 full-stroke cycles	
Audible Noise Rating	Less than 30 dBA at 39-13/32 in. (1 m)	
Electrical Connections	1/2 in. (3.05 m) UL 444 Type CMP plenum-rated cable with 19 AWG (0.75 mm ²) conductors and 1/4 in. (6 mm) ferrule ends	
Conduit Connections	1/2 in. (13 mm) NPSM threaded conduit connectors	
Valve Compatibility	Johnson Controls VB Series Brass Flare Valves and VG7000 Series Bronze Control Valves	
Enclosure	IP54/NEMA 2	
Operating Ambient Conditions	23°F to 131°F (-5°C to 55°C); 90% RH maximum, noncondensing	
Storage Ambient Conditions	-4°F to 149°F (-20°C to 65°C); 90% RH maximum, noncondensing	
Dimensions	5-9/10 in. x 5-1/5 in. x 6-2/5 in. (150 mm x 131 mm x 162 mm)	
Compliance   	United States	UL Listed, CCN XAPX, File E194024; to UL60730-1 Automatic Electric Controls for Household and Similar Use, Part 1: General Requirements, Fourth Edition, dated November 13, 2013; and UL 60730-2-14 Automatic Electrical Controls for Household and Similar Use; Part 2: Particular Requirements for Electric Actuators, Second Edition, Dated February 27, 2013. Plenum-Rated (UL 2043). Suitable for use in other environmental air space (plenums) in accordance with Section 300.22 (C) of the National Electric Code.
	Canada	UL Listed, CCN XAPX7, File E194024; to CAN/CSA-E60730-1:02, Standard for Automatic Electrical Controls for Household and Similar Use, Part 1: General Requirements, Third Edition, dated July 2002; and Amendment, February 1, 2007.
	Europe	CE Mark - Johnson Controls declares that this product is in compliance with the essential requirements and other relevant provisions of the EMC Directive 2004/108/EC and Low Voltage Directive 2006/95/EC.
Shipping Weight	2.85 lb (1.25 kg)	

VA7800 Series Electric Valve Actuators

Description

The VA7800 Series of electric valve actuators control VG7000 Series Bronze Globe Valves in HVAC systems. The VA7800 Series produce a minimum linear output force of 180 lb (800 N) and are ordered field mounted or factory coupled to 1/2 in. through 2 in. VG7000 Series Bronze Globe Valves. All actuators are direct mount and available in both spring-return and non-spring-return models.

Spring-return models ship from the factory set for DC 0 to 10 V Proportional Control. With a change of DIP switch settings, this model can be field configured to On/Off or Floating Control. In addition to these settings, optional auxiliary switches are also available.

Non-spring-return models are available in AC 24 V On/Off (Floating) Control, or DC 0 to 10 V Proportional Control. Models are available with or without optional auxiliary switches.

Refer to the *VA7800 Series Electric Valve Actuators Product Bulletin (LIT-12011474)* for important product application information.

Features

- Automatic Stroke Adjustment — provides easy, quick, and precise commissioning.
- Manual Override as Standard — allows manual positioning of valve for easy commissioning and servicing.
- IP54 Enclosure Protection — allows installation in a wide range of environments.
- Unique Swing-Gate Yoke — offers fast and secure attachment to the valve.
- Brushless Motor — ensures low energy consumption and long life.
- Proportional Model — enables one model to be used for various control types.
- Force-Controlled Motor Shutoff — reduces energy consumption, wear of the actuator, and protects the valve from excessive forces.
- Stroke Position Indicator — gives visual indication of valve operation, provides automatic adjustment of stroke indicators during first cycle of operation.
- Status Light-Emitting Diode (LED) — gives visual indication of actuator status and assists with diagnostic.
- Optional Integrated Auxiliary Switches — provides adjustable switch points with line voltage capability.
- Integral Cable with Colored Conductors — simplifies installation and field wiring.



VA7800 Valve Actuator

- Integral Connector for 3/8 in. (10mm) Flexible Metal Conduit (FMC) — simplifies installation and field wiring.
- Underwriters Laboratories Inc.® (UL) and CE Compliant — provides internationally recognized regulatory agency approval.

Repair Information

If the VA7800 Series Electric Actuator fails to operate within specifications, replace the unit. For a replacement actuator, contact the nearest Johnson Controls® representative.

Selection Chart

Code Number	Input Signal			Power Requirements			Action on Power Failure			Feedback	Auxiliary Switches	Nominal Stroke Time ¹ (Seconds)		
	On/Off	Floating Point	Proportional 0 (2) to 10 VDC 0 (4) to 20 mA	24 VAC 50/60 Hz ± 15%	230 VAC 50/60 Hz ± 15%	VA Rating	Non-Spring Return	Spring-Return Actuator Retracted Valve Stem Full Up	Spring-Return Actuator Extended Valve Stem Full Down			0 (2) to 10 VDC	2 SPDT, 1A, 3A Resistive, 1/4 HP	1/2 and 3/4 in. VG7000 (5/16 in. valve stroke)
VA7810-ADC-2	■	■	—	—	■	8	■	—	—	—	■	48	76	114
VA7810-AGA-2	■	■	—	■	—	3	■	—	—	—	—	48	76	114
VA7810-AGC-2	■	■	—	■	—	3	■	—	—	—	■	48	76	114
VA7810-HGA-2	■	■	■	■	—	6	■	—	—	■	—	24/48	38/76	57/114
VA7810-HGC-2	■	■	■	■	—	6	■	—	—	■	■	24/48	38/76	57/114
VA7820-HGA-2	■	■	■	■	—	11	—	■	—	■	—	24/48	38/76	57/114
VA7820-HGC-2	■	■	■	■	—	11	—	■	—	■	■	24/48	38/76	57/114
VA7830-HGA-2	■	■	■	■	—	11	—	—	■	■	—	24/48	38/76	57/114
VA7830-HGC-2	■	■	■	■	—	11	—	—	■	■	■	24/48	38/76	57/114

1. VA78x0-HGx-2 actuators have field-selectable stroke speed; factory setting is the slowest speed.

VA7800 Series Electric Valve Actuators (Continued)

Accessories

Code Number	Product Description
V-9999-BC1	Mounting Kit to Mount VA-715x, VA-720x, VA78xx, or VA-4233 Series Electric Actuators to Barber Coleman® 1/2 in. through 1-1/4 in. VB-9xxx Valve Bodies
V-9999-HW1	Mounting Kit to Mount VA-715x, VA-720x, VA78xx, or VA-4233 Series Electric Actuators to Honeywell® V5011A, F, and G, 1/2 in. through 3 in. Single-Seated and V5013F Three-Way Valves
M9000-200	Commissioning Tool

Technical Specifications

VA7810-AGx-2 and -ADx-2 Series On/Off (Floating) Electric Non-Spring-Return Valve Actuators		
Model	VA7810-AGx-2	VA7810-ADx-2
Thrust Force	180 lb (800 N) Minimum	
Power Supply	AC 24 V (AC 19 to 30 V) at 50/60 Hz, Class 2	AC 230 V (AC 195 to 265 V) at 50/60 Hz
Transformer Sizing	3 VA	8 VA
Input Signal	AC 24 V (AC 19 to 30 V) at 50/60 Hz	AC 230 V (AC 195 to 265 V) at 50/60 Hz
Feedback	N/A	N/A
Auxiliary Switch Rating	Two Single-Pole, Double-Throw (SPDT), AC 230 V, 3.0 A Resistive, 1/4 hp	
Stroke	5/16 in. to 1 in. (8 mm to 25 mm)	
Stroke Speed	5/16 in. Stroke: 48 Seconds 1/2 in. Stroke: 76 Seconds 3/4 in. Stroke: 114 Seconds	
Ambient Operating Conditions	23°F to 131°F (-5°C to 55°C); 10% to 90% RH Noncondensing	
Enclosure Rating	NEMA 2 (IP54)	
Electrical Connection	48 in. (1.2 m) UL 758 Type AWM Halogen-Free Cable with 18 AWG (0.85 mm ²) Conductors and 0.25 in. (6 mm) Ferrule Ends	
Dimensions	9.6 in. x 4.56 in. x 8.35 in. (244 mm x 116 mm x 212 mm)	
Materials	Gearbox and Yoke	Die Cast Aluminum
	Cover	Resin ABS/PC - UL94-V0
	Stem	Stainless Steel
	Coupler	Brass
Life Cycles	100,000 Full Stroke Cycles	
Shipping Weight	5.4 lb (2.45 kg)	
Compliance	United States	UL 60730 Listed Type 1 Enclosure, CCN XAPX, File E194024
	Canada	UL 60730-1 Listed Type 1 Enclosure, CCD XAPX7, File E194024
	Europe	CE Mark - Johnson Controls declares that this product is in compliance with the essential requirements and other relevant provisions of the EMC directive 2004/108/EC and the Low Voltage Directive 2006/95/EC.

VA7800 Series Electric Valve Actuators (Continued)

VA7810-HGx-2 Series Proportional Electric Non-Spring-Return Valve Actuators		
Model	VA7810-HGx-2	
Thrust Force	180 lb (800 N) Minimum	
Power Supply	AC 24 V (AC 19 to 30 V) at 50/60 Hz, Class 2	
Transformer Sizing	6 VA	
Input Signal	Switch Selectable: Proportional: DC 0 to 10 V, DC 2 to 10 V, 0 to 20 mA or 4 to 20 mA Programmable Proportional: Start Point: 0 VDC to 6 VDC (0 mA to 12 mA) End Point: 3 VDC to 10 VDC (6 mA to 20 mA) with 3 VDC (6 mA) Minimum Span On/Off (Floating): AC 24 V at 50/60 Hz Switch Selectable Direct or Reverse Action with Signal Increase Switch Selectable Preset Actuator Position on Loss of Signal	
Control Input Impedance	Voltage Input: 100k ohm Current Input: 120 ohm	
Feedback	DC 0 (2) to 10 V Corresponds to Input Range	
Auxiliary Switch Rating	SPDT, AC 230 V, 3.0 A Resistive, 1/4 hp	
Stroke	5/16 in. to 1 in. (8 mm to 25 mm)	
Stroke Speed (Switch Selectable)	Slow (Factory Setting)	5/16 in. Stroke: 48 Seconds 1/2 in. Stroke: 76 Seconds 3/4 in. Stroke: 114Seconds
	Fast	5/16 in. Stroke: 24 Seconds 1/2 in. Stroke: 38 Seconds 3/4 in. Stroke: 57 Seconds
Ambient Operating Conditions	23°F to 131°F (-5°C to 55°C); 10% to 90% RH Noncondensing	
Ambient Storage Conditions	-40°F to 176°F (-40°C to 80°C); 5% to 95% RH Noncondensing	
Enclosure Rating	NEMA 2 (IP54)	
Electrical Connection	48 in. (1.2 m) UL 758 Type AWM Halogen-Free Cable with 18 AWG (0.85 mm ²) Conductors and 0.25 in (6 mm) Ferrule Ends	
Dimensions	9.6 in. x 4.56 in. x 8.35 in. (244 mm x 116 mm x 212 mm)	
Materials	Gearbox and Yoke	Die Cast Aluminum
	Cover	Resin ABS/PC - UL94-V0
	Stem	Stainless Steel
	Coupler	Brass
Life Cycles	100,000 Full Stroke Cycles	
Shipping Weight	5.4 lb (2.45 kg)	
Compliance 	United States	UL 60730 Listed Type 1 Enclosure, CCN XAPX, File E194024
	Canada	UL 60730-1 Listed Type 1 Enclosure, CCN XAPX7, File E194024
	Europe	CE Mark - Johnson Controls declares that this product is in compliance with the essential requirements and other relevant provisions of the EMC directive 2004/108/EC and the Low Voltage Directive 2006/95/EC.

VA7800 Series Electric Valve Actuators (Continued)

VA7820-HGx-2 / VA7830-HGx-2 Series Proportional Electric Spring-Return Valve Actuators		
Model	VA7820-HGx-2 / VA7830-HGx-2	
Thrust Force	180 lb (800 N) Minimum	
Power Supply	AC 24 V (AC 19 to 30 V) at 50/60 Hz, Class 2	
Transformer Sizing	11 VA	
Input Signal	Switch Selectable: Proportional: DC 0 to 10 V, DC 2 to 10 V, 0 to 20 mA or 4 to 20 mA Programmable Proportional: Start Point: 0 VDC to 6 VDC (0 mA to 12 mA) End Point: 3 VDC to 10 VDC (6 mA to 20 mA) with a 3 VDC (6 mA) Minimum Span On/Off (Floating): AC 24 V at 50/60 Hz Switch Selectable Direct or Reverse Action with Signal Increase Switch Selectable Reset Actuator Position on Loss of Signal	
Control Input Impedance	Voltage Input: 100k ohm Current Input: 120 ohm	
Feedback	DC 0 (2) to 10 V Corresponds to Input Range	
Auxiliary Switch Rating	SPDT, AC 230 V, 3.0 A Resistive, 1/4 hp	
Stroke	5/16 in. to 1 in. (8 mm to 25 mm)	
Stroke Speed	Slow (Factory Setting)	5/16 in. Stroke: 48 Seconds 1/2 in. Stroke: 76 Seconds 3/4 in. Stroke: 114 Seconds
	Fast	5/16 in. Stroke: 24 Seconds 1/2 in. Stroke: 38 Seconds 3/4 in. Stroke: 57 Seconds
Ambient Operating Conditions	23°F to 131°F (-5°C to 55°C); 10% to 90% RH Noncondensing	
Ambient Storage Conditions	-40°F to 176°F (-40°C to 80°C); 5% to 95% RH Noncondensing	
Enclosure Rating	NEMA 2 (IP54)	
Electrical Connection	48 in. (1.2 m) UL 758 Type AWM Halogen-Free Cable with 18 AWG (0.85 mm ²) Conductors and 0.25 in. (6 mm) Ferrule Ends	
Dimensions	9.6 in. x 4.56 in. x 8.35 in. (244 mm x 116 mm x 212 mm)	
Materials	Gearbox and Yoke	Die Cast Aluminum
	Cover	Resin ABS/PC - UL94-V0
	Stem	Stainless Steel
	Coupler	Brass
Life Cycles	100,000 Full Stroke Cycles	
Shipping Weight	7.3 lb (3.3 kg)	
Compliance	United States	UL 60730 Listed Type 1 Enclosure, CCN XAPX, File E194024
	Canada	UL 60730-1 Listed Type 1 Enclosure, CCN XAPX7, File E194024
	Europe	CE Mark - Johnson Controls declares that this product is in compliance with the essential requirements and other relevant provisions of the EMC directive 2004/108/EC and the Low Voltage Directive 2006/95/EC.



V-3801-8001 Pneumatic Valve Actuator

Description

The V-3801-8001 Pneumatic Valve Actuator is designed to accurately position steam or water valve modulating plugs in response to a pneumatic signal from a controller. The small oval top makes the V-3801-8001 ideally suited for 1/2 in. and 3/4 in. VG7000 Series valve applications with restricted mounting space. This actuator has a molded synthetic rubber diaphragm design. The molded diaphragm provides a constant effective area throughout the actuator stroke. All parts are protected by a sturdy die-case aluminum housing.

Refer to the *V-3801-8001 Pneumatic Valve Actuator Product Bulletin (LIT-977253)* for important product application information.

Features

- compact design fits into restricted mounting spaces
- single set screw design provides easy assembly
- rolling diaphragm design provides constant effective diaphragm area throughout stroke for optimal force output
- easily field mounted to the valve bonnet with a single set screw, refer to the accessories chart.

Applications

The V-3801-8001 Valve Actuator is used on 1/2 in. and 3/4 in. VG7000 Series Valves. The V-3801-8001 is not recommended for sequencing because its relatively small size and small output force may result in unacceptable spring shift. Where pneumatic sequencing is required, the V-3000-800x Series actuators are recommended. The V-3802-1 and V-3801-8001 are not interchangeable.



**V-3801-8001
Pneumatic Valve Actuator**

Repair Information

If the V-3801-8001 Pneumatic Actuator fails to operate within its specifications, replace the unit. For a replacement actuator, contact the nearest Johnson Controls® representative.

Selection Chart

Code Number	Description
V-3801-8001	Pneumatic valve actuator

Accessories

Code Number	Description
VG7000-1010	Spring kit with 3 psig to 6 psig spring
VG7000-1011	Spring kit with 4 psig to 8 psig spring
VG7000-1012	Spring kit with 9 psig to 13 psig spring
VG7000-1015	Spring kit with 3 springs: 3 psig to 6 psig, 4 psig to 8 psig, and 9 psig to 13 psig (includes hardware to adapt to one valve)

Technical Specifications

V-3801-8001 Pneumatic Valve Actuator	
Maximum Control Pressure	30 psig (207 kPa)
Air Connection	1/8 in. NPT barbed fitting for 1/4 in. or 5/32 in. O.D. polytubing
Ambient Operating Temperature Limits	-20°F to 150°F (-29°C to 66°C) ¹
Maximum Storage Temperatures	150°F (66°C)
Effective Diaphragm Area	4 sq. in.
Materials	Housing: die cast aluminum Diaphragm: synthetic rubber
Shipping Weight	0.5 lb (0.23 kg)

1. For use on steam systems with 15 psig (103 kPa) or less inlet pressure

V-3000-8012, V-3000-8003 Pneumatic Valve Actuators

Description

The V-3000-8012 and V-3000-8003 Pneumatic Valve Actuators are designed to accurately position steam or water valve modulating plugs in response to a pneumatic signal from a controller. A V-9502 Valve Positioner can be ordered separately for use with the V-3000-8012 only, in applications where sequential operation is desired or additional positioning power is necessary. The actuators have a molded synthetic rubber diaphragm design. This molded diaphragm provides a constant effective area throughout the actuator stroke. All parts are protected by a sturdy die-cast aluminum housing.

Refer to the *V-3000-8012 (Exposed) and V-3000-8003 (Enclosed) Pneumatic Valve Actuators Product Bulletin (LIT-977252)* for important product application information.

Features

- universal valve mounting design is compatible for use on all Johnson Controls® valves with V-3000 mounting configurations
- rolling diaphragm design provides constant effective diaphragm area throughout stroke for optimal force output
- integral stroke position indicator provides visual reference to valve position

Applications

Used on the following: VG7000 Series, VTM Series, V-3752 Series, V-3754 Series, V-3762 Series, V-3766 Series, V-3966 Series, V-3974 Series, V-4324 Series, V-4332 Series, V-4334 Series, and V-4440 Series.

The V-3000-8012 and V-3000-8003 can replace the V-3000-1 and V-3000-2.



Exposed V-3000-8012 and V-3000-8003 Pneumatic Valve Actuators

Selection Chart

Code Number	Description
V-3000-8012	Exposed yoke
V-3000-8003	Enclosed yoke

Accessories and Repair Parts

Code Number	Description
Exposed Model (V-3000-8012) Accessories	
V-3000-600	Replacement diaphragm for V-3000-8012
V-9502-90	Pilot positioner (less spring), mounts to V-3000-8012 only
V-9502-6801	Pilot Positioner Springs: 5/16 in. stroke (8 mm lift) - 3 psi (21 kPa) span 1/2 in. stroke (13 mm lift) - 5 psi (34 kPa) span 3/4 in. stroke (19 mm lift) - 10 psi (69 kPa) span
V-9502-6802	Pilot Positioner Springs: 5/16 in. stroke (8 mm lift) - 8 psi (55 kPa) span 1/2 in. stroke (13 mm lift) - 12 psi (83 kPa) span
V-9502-6803	Pilot Positioner Springs: 3/4 in. stroke (19 mm lift) 4 psi span
	Valve Spring Kits: Refer to the specific valve product for spring kit code numbers.
Enclosed Model (V-3000-8003) Accessory	
V-3000-6001	Replacement diaphragm for V-3000-8003

Technical Specifications

V-3000-8012, V-3000-8003 Pneumatic Valve Actuators	
Maximum Control Pressure	25 psig (172 kPa)
Air Connection	Barb fitting: 5/32 or 1/4 x 1/8 National Pipe Thread (NPT)
Ambient Operating Temperature Limits	-20°F to 150°F (-29°C to 66°C)
Maximum Storage Temperature	150°F (66°C)
Effective Diaphragm Area	8 in. ² (51.2 cm ²)
Materials	Housing: Die cast aluminum Diaphragm: Synthetic rubber
Shipping Weight	V-3000-8012: 1.1 lb (0.49 kg) V-3000-8003: 1 lb (0.45 kg)

MP8000 Series Pneumatic Valve Actuators

Description

MP8000 Series Pneumatic Valve Actuators are designed to accurately position hot-water, chilled-water, and steam-control valves in response to a pneumatic signal from a controller. A pneumatic or electric valve positioner can be ordered separately for use in applications where sequential operation is desired or additional positioning power is necessary. MP8000 Series Actuators have a molded, synthetic rubber diaphragm contained in a sturdy, corrosion-resistant housing that protects against dirt and damage. This molded diaphragm provides a constant effective area throughout the actuator stroke.

Refer to the *MP8000 Series Pneumatic Valve Actuators Product Bulletin (LIT-977257)* for important product application information.

Features

- universal-application design allows for use in hot water, chilled water, and steam
- field-reversible action allows for selectable spring-return-up or spring-return-down action on N.O. valves
- strong, corrosion-resistant housing ensures long life
- position indicator, included with every actuator, provides visual indication of valve stem position



**MP8000 Series
Pneumatic Valve Actuators**

Repair Information

If the MP8000 Series Pneumatic Actuator fails to operate within its specifications, replace the unit. For a replacement actuator, contact the nearest Johnson Controls® representative.

Selection Charts

MP8000 Series Pneumatic Valve Actuators

Actuator Size, sq. in.	Stroke, in.	Included Mounting Kit	Actuator Model					
			Spring Return Up			Spring Return Down		
			3 to 7 psig	4 to 8 psig	9 to 13 psig	3 to 7 psig	4 to 8 psig	9 to 13 psig
25	5/16	None	MP821C001	MP821D001	MP821E001	MP831C001	MP831D001	MP831E001
		MP8000-6701	MP821C001B	MP821D001B	MP821E001B			
	1/2	None	MP822C001	MP822D001	MP822E001	MP832C001	MP832D001	MP832E001
		MP8000-6702	MP822C001A	MP822D001A	MP822E001A			
	3/4	None	MP823C001	MP823D001	MP823E001	MP833C001	MP833D001	MP833E001
		MP8000-6702	MP823C001A	MP823D001A	MP823E001A			
MP8000-6501		MP823C001D	MP823D001D	MP823E001D	MP833C001D	MP833D001D	MP833E001D	
		MP8000-6201	MP823C001E	MP823D001E	MP823E001E	MP833C001E	MP833D001E	MP833E001E
50	3/4	None	MP843C001	MP843D001	MP843E001	MP853C001	MP853D001	MP853E001
		MP8000-6703	MP843C001C	MP843D001C	MP843E001C			
		MP8000-6201	MP843C001F	MP843D001F	MP843E001F	MP853C001F	MP853D001F	MP853E001F
	1	None	MP844C001	MP844D001	MP844E001	MP854C001	MP854D001	MP854E001
	1-1/8	None	MP845C001	MP845D001	MP845E001	MP855C001	MP855D001	MP855E001
		MP8000-6201	MP845C001F	MP845D001F	MP845E001F	MP855C001F	MP855D001F	MP855E001F
100	1-1/8	None	MP865C001	MP865D001	MP865E001	MP875C001	MP875D001	MP875E001
		MP8000-6203	MP865C001G	MP865D001G	MP865E001G	MP875C001G	MP875D001G	MP875E001G
	1-1/2	None	MP867C001	MP867D001	MP867E001	MP877C001	MP877D001	MP877E001
		MP8000-6203	MP867C001G	MP867D001G	MP867E001G	MP877C001G	MP877D001G	MP877E001G

MP8000 Series Pneumatic Valve Actuators (Continued)

Mounting Kits (for Assembly in the Field)

Code Number	Description
MP8000-6201	Mounting Kit for MP82, MP83, MP84, or MP85 Series Actuators Mounted to 2-1/2 in., 3 in., or 4 in. VG2000, V-5252, V-5462, or V-5842 Cast Iron Flanged Globe Valves with 3/8 in. Stem (Kit Includes: Two Stem Hex Jam Nuts and One Locknut)
MP8000-6203	Mounting Kit for MP86 or MP87 Series Actuators Mounted to 3 in., 4 in., 5 in., or 6 in. VG2000, V-5252, V-5462, or V-5842 Cast Iron Flanged Globe Valves with 1/2 in. Stem (Kit Includes: Two Stem Hex Jam Nuts and One Locknut)
MP8000-6501	Mounting Kit for MP82 or MP83 Series Actuators Mounted to 1-1/2 in. or 2 in. V-5254, V-5464, or V-5844 Series Cage Trim Valves with 1/4 in. Stem (Kit Includes: One Stem Nut, One Stem Extender, Two Stem Extender Nuts, and One Yoke Nut)
MP8000-6701	Mounting Kit for MP82 or MP83 Series Actuators Mounted to 1/2 in. or 3/4 in. VG7000 Series Bronze Control Valves with Stainless Steel Trim (Kit Includes: One Stem Nut, One Stem Extender, Two Stem Extender Nuts, and One Yoke Nut)
MP8000-6702	Mounting Kit for MP82 or MP83 Series Actuators Mounted to 1 in. through 2 in. VG7000 Series Bronze Control Valves with 1/4 in. Stem and Stainless Steel or Brass Trim (Kit Includes: One Stem Nut, One Stem Extender, Two Stem Extender Nuts, and One Yoke Nut)
MP8000-6703	Mounting Kit for MP84 or MP85 Series Actuators Mounted to 1-1/2 in. or 2 in. VG7000 Series Bronze Control Valves with 3/8 in. Stem and Stainless Steel Trim (Kit Includes: Two Stem Nuts and One Yoke Nut)

Positioners and Positioner Mounting Kits (Order Separately)

Code Number	Description
V-9502-95	Pneumatic Valve Actuator Positioner (Less Spring and Mounting Hardware)
MP8000-6002	Mounting Kit for V-9502-95 Pneumatic Valve Actuator Positioner (Kit Includes All Necessary Mounting Hardware and Six Springs)
EPP-1000-8	Electro-Pneumatic Valve Actuator Positioner (Less Mounting Hardware)
MP8000-6003	Mounting Kit for EPP-1000-8 Electro-Pneumatic Valve Actuator Positioner (Kit Includes All Necessary Mounting Hardware)

Accessories and Maintenance Parts

Code Number	Description
MP8000-6001	Seal Kit for All MP8000 Series Actuators
MP8000-6325	Diaphragm and Seal Kit for MP82 and MP83 Series Actuators
MP8000-6350	Diaphragm and Seal Kit for MP84, MP85, MP86, and MP87 Series Actuators (Two Kits Required for MP86 and MP87 Series Actuators)
MP8000-6012 ¹	Repair Tool Kit (Required for Diaphragm and Seal Replacement)

1. This kit includes a strap handle and polyester strap, stem wrench, and 7/16 in. hex tool.

Technical Specifications

MP8000 Series Pneumatic Valve Actuators		
Effective Diaphragm Area	MP82/MP83 Series Actuators	25 sq. in. (Size 150)
	MP84/MP85 Series Actuators	50 sq. in. (Size 300)
	MP86/MP87 Series Actuators	100 sq. in. (Size 600)
Maximum Control Pressure		25 psig (172 kPa)
Air Connection		Barbed Fitting for 1/4 in. O.D. Poly tubing
Ambient Operating Temperature Limits		-20°F to 150°F (-29°C to 66°C)
Ambient Storage Temperature Limits		-40°F to 176°F (-40°C to 80°C)
Materials	Housing	Die-Formed Carbon Steel (Coated with Corrosion-Resistant Finish)
	Diaphragm	Ethylene Propylene Diene Monomer (EPDM)
	Stem Seals	Nitrile U-Cups
	Bearings	Reinforced Thermoplastic
	Yoke	Formed Steel (Coated with Corrosion-Resistant Finish)
	Spring	Chrome-Silicon Steel (Coated with Corrosion-Resistant Finish)
	Stem Components	Stainless Steel
Shipping Weight	MP82/MP83 Series Actuators	14.0 lb (6.4 kg)
	MP84/MP85 Series Actuators	31.0 lb (14.1 kg)
	MP86/MP87 Series Actuators	47.0 lb (21.3 kg)

Repair Parts and Replacement Diaphragms for V-3000 Series Actuators

Description

The repair parts listed can extend the service life of the V-3000 Series actuators. All parts can be replaced without removing the valve from the system.

Refer to the *V-3000 Pneumatic Valve Actuator Exposed or Enclosed Product Bulletin (LIT-977250)* for important product application information.

Selection Chart

Code Number	Callout	Description
V-3000-6000	A	Diaphragm for Exposed Actuator (V-3000-1 Only)
V-3000-6001		Diaphragm for Enclosed Actuator (V-3000-2 and V-3000-8003)
V-3100-6043	B	10-32 x 1/2 UNF-2A Set Screw (Package of 10)
V-3000-6005	C	Spider for V-3008
V-3000-6006		Spider for V-3002

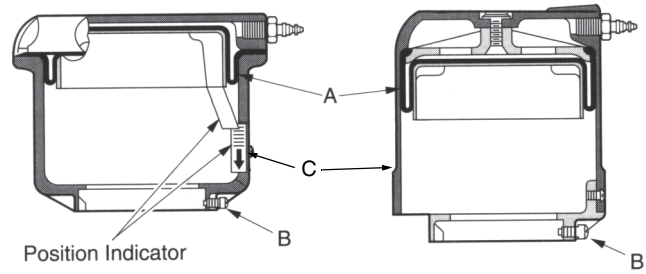

Repair Parts, V-3000 Series Actuator

VG7000 Series Bronze Globe Valves, Maintenance and Repair

Description

The packing and reconditioning kits in the Selection Chart include all components necessary to return a VG7000 Series Bronze Globe Valve to near new condition.

Selection Chart

Code Number	Description
Packing Kits	
VG7000-6001	Ring Pack, Single Pack, for Brass Trim Valves with 1/4 in. Stem (1/2 in. or 3/4 in. Valves). Kit Includes: Two Ring Packs (U-Cup with Installed O-Ring), One Stem Guide, One Insertion/Removal Tool, One Bullet, One Grease Tube, and One 3 in. Strip of Crocus Cloth.
VG7000-6002	Ring Pack, Single Pack, for Brass Trim Valves with 3/8 in. Stem (1 in. through 2 in. Valves). Kit Includes: Two Ring Packs (U-Cup with Installed O-Ring), One Stem Wiper, One Stem Guide, One Insertion/Removal Tool, One Sleeve Packing Installer, One Grease Tube, and One 3 in. Strip of Crocus Cloth.
VG7000-6011	PTFE V-Ring Pack for Stainless Steel Trim Valves with 1/4 in. Stem (1/2 in. or 3/4 in. Valves). Kit Includes: Two Teflon® V-Rings, One Rubber V-Ring, Two Teflon Stem Wipers, One Teflon Stem Guide, One Teflon Bushing, One Steel Washer, One Spring, One Insertion/Removal Tool, One Bullet, One Grease Tube, and One 3 in. Strip of Crocus Cloth.
VG7000-6012	PTFE V-Ring Pack for Stainless Steel Trim Valves with 3/8 in. Stem (1 in. through 2 in. Valves). Kit Includes: Two Teflon V-Rings, One Rubber V-Ring, Two Teflon Stem Wipers, One Teflon Stem Guide, One Teflon Bushing, One Steel Washer, One Spring, One Insertion/Removal Tool, One Sleeve Packing Installer, One Grease Tube, and One 3 in. Strip of Crocus Cloth.
Valve Reconditioning Kits¹	
VG72K1CS	Reconditioning Kit for 1/2 in., 0.73 Cv, Two-Way N.O./Push-Down-to-Close Valves, Brass Trim, Equal Percentage Flow Characteristics with Slotted Stem for Use with V-3801 or VA-8x2x Series Actuators.
VG72K1CT	Reconditioning Kit for 1/2 in., 0.73 Cv, Two-Way N.O./Push-Down-to-Close Valves, Brass Trim, Equal Percentage Flow Characteristics with Threaded Stem for Use with All Actuators Except V-3801, VA-8x2x, V-500, and MP84.
VG72K1ES	Reconditioning Kit for 1/2 in., 1.8 Cv, Two-Way N.O./Push-Down-to-Close Valves, Brass Trim, Equal Percentage Flow Characteristics with Slotted Stem for Use with V-3801 or VA-8x2x Series Actuators.
VG72K1ET	Reconditioning Kit for 1/2 in., 1.8 Cv, Two-Way N.O./Push-Down-to-Close Valves, Brass Trim, Equal Percentage Flow Characteristics with Threaded Stem for Use with All Actuators Except V-3801, VA-8x2x, V-500, and MP84.
VG72K1GS	Reconditioning Kit for 1/2 in., 4.6 Cv, Two-Way N.O./Push-Down-to-Close Valves, Brass Trim, Equal Percentage Flow Characteristics with Slotted Stem for Use with V-3801 or VA-8x2x Series Actuators.
VG72K1GT	Reconditioning Kit for 1/2 in., 4.6 Cv, Two-Way N.O./Push-Down-to-Close Valves, Brass Trim, Equal Percentage Flow Characteristics with Threaded Stem for Use with All Actuators Except V-3801, VA-8x2x, V-500, and MP84.
VG72K1LS	Reconditioning Kit for 3/4 in., 7.3 Cv, Two-Way N.O./Push-Down-to-Close Valves, Brass Trim, Equal Percentage Flow Characteristics with Slotted Stem for Use with V-3801 or VA-8x2x Series Actuators.
VG72K1LT	Reconditioning Kit for 3/4 in., 7.3 Cv, Two-Way N.O./Push-Down-to-Close Valves, Brass Trim, Equal Percentage Flow Characteristics with Threaded Stem for Use with All Actuators Except V-3801, VA-8x2x, V-500, and MP84.
VG72K1NT	Reconditioning Kit for 1 in., 11.6 Cv, Two-Way N.O./Push-Down-to-Close Valves, Brass Trim, Equal Percentage Flow Characteristics with Threaded Stem for Use with All Actuators Except V-3801, VA-8x2x, V-500, and MP84.
VG72K1PT	Reconditioning Kit for 1-1/4 in., 18.5 Cv, Two-Way N.O./Push-Down-to-Close Valves, Brass Trim, Equal Percentage Flow Characteristics with Threaded Stem for Use with All Actuators Except V-3801, VA-8x2x, V-500, and MP84.
VG72K1RT	Reconditioning Kit for 1-1/2 in., 28.9 Cv, Two-Way N.O./Push-Down-to-Close Valves, Brass Trim, Equal Percentage Flow Characteristics with Threaded Stem for Use with All Actuators Except V-3801, VA-8x2x, V-500, and MP84.
VG72K1ST	Reconditioning Kit for 2 in., 46.2 Cv, Two-Way N.O./Push-Down-to-Close Valves, Brass Trim, Equal Percentage Flow Characteristics with Threaded Stem for Use with All Actuators Except V-3801, VA-8x2x, V-500, and MP84.
VG72K3NT	Reconditioning Kit for 1 in., 11.6 Cv, Two-Way N.O./Push-Down-to-Close Valves, Stainless Steel Trim, Equal Percentage Flow Characteristics with Threaded Stem for Use with All Actuators Except V-3801, VA-8x2x, V-500, and MP84.
VG74K1CS	Reconditioning Kit for 1/2 in., 0.73 Cv, Two-Way N.C./Push-Down-to-Open Valves, Brass Trim, Equal Percentage Flow Characteristics with Slotted Stem for Use with V-3801 or VA-8x2x Series Actuators.
VG74K1CT	Reconditioning Kit for 1/2 in., 0.73 Cv, Two-Way N.C./Push-Down-to-Open Valves, Brass Trim, Equal Percentage Flow Characteristics with Threaded Stem for Use with All Actuators Except V-3801, VA-8x2x, V-500, and MP84.
VG74K1ES	Reconditioning Kit for 1/2 in., 1.8 Cv, Two-Way N.C./Push-Down-to-Open Valves, Brass Trim, Equal Percentage Flow Characteristics with Slotted Stem for Use with V-3801 or VA-8x2x Series Actuators.
VG74K1ET	Reconditioning Kit for 1/2 in., 1.8 Cv, Two-Way N.C./Push-Down-to-Open Valves, Brass Trim, Equal Percentage Flow Characteristics with Threaded Stem for Use with All Actuators Except V-3801, VA-8x2x, V-500, and MP84.
VG74K1GS	Reconditioning Kit for 1/2 in., 4.6 Cv, Two-Way N.C./Push-Down-to-Open Valves, Brass Trim, Equal Percentage Flow Characteristics with Slotted Stem for Use with V-3801 or VA-8x2x Series Actuators.
VG74K1GT	Reconditioning Kit for 1/2 in., 4.6 Cv, Two-Way N.C./Push-Down-to-Open Valves, Brass Trim, Equal Percentage Flow Characteristics with Threaded Stem for Use with All Actuators Except V-3801, VA-8x2x, V-500, and MP84.
VG74K1LS	Reconditioning Kit for 3/4 in., 7.3 Cv, Two-Way N.C./Push-Down-to-Open Valves, Brass Trim, Equal Percentage Flow Characteristics with Slotted Stem for Use with V-3801 or VA-8x2x Series Actuators.
VG74K1LT	Reconditioning Kit for 3/4 in., 7.3 Cv, Two-Way N.C./Push-Down-to-Open Valves, Brass Trim, Equal Percentage Flow Characteristics with Threaded Stem for Use with All Actuators Except V-3801, VA-8x2x, V-500, and MP84.
VG74K1NT	Reconditioning Kit for 1 in., 11.6 Cv, Two-Way N.C./Push-Down-to-Open Valves, Brass Trim, Equal Percentage Flow Characteristics with Threaded Stem for Use with All Actuators Except V-3801, VA-8x2x, V-500, and MP84.

The performance specifications are nominal and conform to acceptable industry standards. For applications at conditions beyond these specifications, consult the local Johnson Controls office. Johnson Controls shall not be liable for damages resulting from misapplication or misuse of its products. © 2019 Johnson Controls. www.johnsoncontrols.com

VG7000 Series Bronze Globe Valves, Maintenance and Repair (Continued)

Code Number	Description
VG74K1PT	Reconditioning Kit for 1-1/4 in., 18.5 Cv, Two-Way N.C./Push-Down-to-Open Valves, Brass Trim, Equal Percentage Flow Characteristics with Threaded Stem for Use with All Actuators Except V-3801, VA-8x2x, V-500, and MP84.
VG74K1RT	Reconditioning Kit for 1-1/2 in., 28.9 Cv, Two-Way N.C./Push-Down-to-Open Valves, Brass Trim, Equal Percentage Flow Characteristics with Threaded Stem for Use with All Actuators Except V-3801, VA-8x2x, V-500, and MP84.
VG74K1RT+W	Reconditioning Kit for 1-1/2 in., 28.9 Cv, Two-Way N.C./Push-Down-to-Open Valves, Brass Trim, Equal Percentage Flow Characteristics with Threaded Stem for Use with All Actuators Except V-3801, VA-8x2x, V-500, and MP84. Includes VG74K1RT Reconditioning Kit Plus Bottom Cap with Stem Guide.
VG74K1ST	Reconditioning Kit for 2 in., 46.2 Cv, Two-Way N.C./Push-Down-to-Open Valves, Brass Trim, Equal Percentage Flow Characteristics with Threaded Stem for Use with All Actuators Except V-3801, VA-8x2x, V-500, and MP84.
VG74K1ST+W	Reconditioning Kit for 2 in., 46.2 Cv, Two-Way N.C./Push-Down-to-Open Valves, Brass Trim, Equal Percentage Flow Characteristics with Threaded Stem for Use with All Actuators Except V-3801, VA-8x2x, V-500, and MP84. Includes VG74K1ST Reconditioning Kit Plus Bottom Cap with Stem Guide.
VG74K3CT	Reconditioning Kit for 1/2 in., 0.73 Cv, Two-Way N.C./Push-Down-to-Open Valves, Stainless Steel Trim, Equal Percentage Flow Characteristics with Threaded Stem for Use with All Actuators Except V-3801, VA-8x2x, V-500, and MP84.
VG74K3ET	Reconditioning Kit for 1/2 in., 1.8 Cv, Two-Way N.C./Push-Down-to-Open Valves, Stainless Steel Trim, Equal Percentage Flow Characteristics with Threaded Stem for Use with All Actuators Except V-3801, VA-8x2x, V-500, and MP84.
VG74K3LT	Reconditioning Kit for 3/4 in., 7.3 Cv, Two-Way N.C./Push-Down-to-Open Valves, Stainless Steel Trim, Equal Percentage Flow Characteristics with Threaded Stem for Use with All Actuators Except V-3801, VA-8x2x, V-500, and MP84.
VG74K3PT	Reconditioning Kit for 1-1/4 in., 18.5 Cv, Two-Way N.C./Push-Down-to-Open Valves, Stainless Steel Trim, Equal Percentage Flow Characteristics with Threaded Stem for Use with All Actuators Except V-3801, VA-8x2x, V-500, and MP84.
VG78K2CS	Reconditioning Kit for 1/2 in., 0.73 Cv, Three-Way Mixing Valves, Brass Trim, Linear Flow Characteristics with Slotted Stem for Use with V-3801 or VA-8x2x Series Actuators.
VG78K2CT	Reconditioning Kit for 1/2 in., 0.73 Cv, Three-Way Mixing Valves, Brass Trim, Linear Flow Characteristics with Threaded Stem for Use with All Actuators Except V-3801, VA-8x2x, V-500, and MP84.
VG78K2ES	Reconditioning Kit for 1/2 in., 1.8 Cv, Three-Way Mixing Valves, Brass Trim, Linear Flow Characteristics with Slotted Stem for Use with V-3801 or VA-8x2x Series Actuators.
VG78K2ET	Reconditioning Kit for 1/2 in., 1.8 Cv, Three-Way Mixing Valves, Brass Trim, Linear Flow Characteristics with Threaded Stem for Use with All Actuators Except V-3801, VA-8x2x, V-500, and MP84.
VG78K2GS	Reconditioning Kit for 1/2 in., 4.6 Cv, Three-Way Mixing Valves, Brass Trim, Linear Flow Characteristics with Slotted Stem for Use with V-3801 or VA-8x2x Series Actuators.
VG78K2GT	Reconditioning Kit for 1/2 in., 4.6 Cv, Three-Way Mixing Valves, Brass Trim, Linear Flow Characteristics with Threaded Stem for Use with All Actuators Except V-3801, VA-8x2x, V-500, and MP84.
VG78K2LS	Reconditioning Kit for 3/4 in., 7.3 Cv, Three-Way Mixing Valves, Brass Trim, Linear Flow Characteristics with Slotted Stem for Use with V-3801 or VA-8x2x Series Actuators.
VG78K2LT	Reconditioning Kit for 3/4 in., 7.3 Cv, Three-Way Mixing Valves, Brass Trim, Linear Flow Characteristics with Threaded Stem for Use with All Actuators Except V-3801, VA-8x2x, V-500, and MP84.
VG78K2NT	Reconditioning Kit for 1 in., 11.6 Cv, Three-Way Mixing Valves, Brass Trim, Linear Flow Characteristics with Threaded Stem for Use with All Actuators Except V-3801, VA-8x2x, V-500, and MP84.
VG78K2PT	Reconditioning Kit for 1-1/4 in., 18.5 Cv, Three-Way Mixing Valves, Brass Trim, Linear Flow Characteristics with Threaded Stem for Use with All Actuators Except V-3801, VA-8x2x, V-500, and MP84.
VG78K2RT	Reconditioning Kit for 1-1/2 in., 28.9 Cv, Three-Way Mixing Valves, Brass Trim, Linear Flow Characteristics with Threaded Stem for Use with All Actuators Except V-3801, VA-8x2x, V-500, and MP84.
VG78K2RT+4	Reconditioning Kit for 1-1/2 in., 28.9 Cv, Three-Way Mixing Valves, Brass Trim, Linear Flow Characteristics with Threaded Stem for Use with All Actuators Except V-3801, VA-8x2x, V-500, and MP84. Includes VG78K2RT Reconditioning Kit Plus Lower Valve Body with Stem Guide.
VG78K2ST	Reconditioning Kit for 2 in., 46.2 Cv, Three-Way Mixing Valves, Brass Trim, Linear Flow Characteristics with Threaded Stem for Use with All Actuators Except V-3801, VA-8x2x, V-500, and MP84.
VG78K2ST+4	Reconditioning Kit for 2 in., 46.2 Cv, Three-Way Mixing Valves, Brass Trim, Linear Flow Characteristics with Threaded Stem for Use with All Actuators Except V-3801, VA-8x2x, V-500, and MP84. Includes VG78K2ST Reconditioning Kit Plus Lower Valve Body with Stem Guide.

- For brass trim kits, the reconditioning kits include a bonnet, packing, and stem and plug assembly.
For stainless steel kits, the reconditioning kits include a bonnet, packing, and stem and plug assembly.



WARNING This product is made of copper alloy, which contains lead. The product is therefore not to be used on drinking water.



WARNING This product can expose you to chemicals including lead, which is known to the State of California to cause cancer, birth defects, or other reproductive harm. For more information, go to www.P65Warnings.ca.gov.

WARNING: BRASS MAY CONTAIN LEAD

To fulfill our obligations towards Article 33, in accordance to the European REACH Regulation No 1907/2006 EC, we hereby inform you that this article contains the following Substances of Very High Concern mentioned on the Candidate list:

- Lead

V-9502 Series Pneumatic Valve Actuator Positioners

Description

V-9502 Series Pneumatic Valve Actuator Positioners are precision relay devices designed to operate pneumatic valve actuators in applications requiring stable, accurate control. These positioners provide maximum positioning power to resist external forces that might otherwise overcome the positioning power of the actuator. Adjustable operating span (on all pneumatic valve actuators except the V-3000 Series) and starting point also make the V-9502 ideal for valve sequencing applications. The V-9502 Series can be mounted directly to V-3000 Series, 3R, 4R, 5R, 8R, or MP8000 Series pneumatic valve actuators. In many instances, the positioner can be ordered factory installed on these actuator and valve assemblies.

Feedback from the actuator stem (through the positioner spring and lever arm assembly) activates the V-9502 Pneumatic Valve Actuator Positioner to compensate for flow surges in the piping system, and holds the valve at the position dictated by the controller. The V-9502 modulates the stroke of the actuator in relation to a pressure change from the controller. Repositioning is very precise for small changes in the output pressure from the controller.

The span and starting point adjustments of the V-9502 Pneumatic Valve Actuator Positioner determine the operating range. The lower value of the operating range is the control signal pressure at which the actuator just begins to stroke. The upper value of the operating range is the control signal pressure at which the actuator reaches its maximum stroke. The difference between the upper and lower values of the control signal pressure is the operating span.

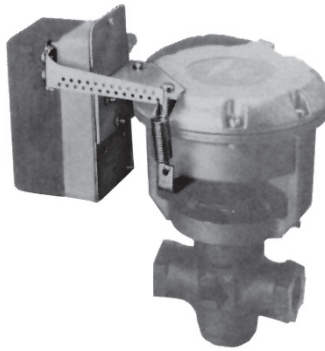

V-9502 Positioner Installed on a Typical V-3000 Type Valve Actuator

The operating span of the V-9502 Pneumatic Valve Actuator Positioner is field selectable from 3 psi to 13 psi (21 kPa to 90 kPa) on 3R, 4R, 5R, 8R, and MP8000 Series pneumatic valve actuators. The operating span is determined by the location of the spring in the positioner operating span lever arm. When the spring is installed in the hole closest to the V-9502 Positioner cover, the spring allows a span of 3 psi (21 kPa). When the spring is installed in the hole furthest from the positioner cover, the spring allows a span of 13 psi (90 kPa).

The operating span for V-3000 Series Pneumatic Valve Actuators is determined by the positioner spring used with the actuator. To change the operating span, simply select a different positioner spring from the appropriate selection chart that follows.

The starting point is the input pressure (Pilot P pressure) at which the actuator just begins to stroke. The starting point is field adjustable from 2 psig to 12 psig (14 kPa to 83 kPa) using the starting point adjusting screw located under the V-9502 Positioner cover. Turning the screw clockwise decreases the starting point, and turning the screw counterclockwise increases the starting point.



V-9502 Positioner Installed on a Rubber Diaphragm Type Valve Actuator

Refer to the *V-9502 Series Pneumatic Valve Actuator Positioners Product Bulletin (LIT-977265)* for important product application information.

Features

- maximum positioning power compensates for flow surges in the piping system, and holds the valve at the position dictated by the controller
- field-selectable operating span (all pneumatic valve actuators except V-3000 Series) provides application flexibility and allows for easy valve sequencing from a single control signal
- field-adjustable starting point provides accurate control since it can be tailored for the specific application
- can be mounted directly to V-3000 Series, 3R, 4R, 5R, 8R, or MP8000 Series, expanding usability and providing application flexibility

Selection Charts

V-9502 Pneumatic Valve Actuator Positioners

Code Number	Valve Type	Stem Diameter, in. (mm)	Diaphragm Size
V-9502-1 ¹	V-5250, V-5460, V-5650, V-5840 Valves	1/4 (6)	3R
V-9502-2 ¹		1/4 (6)	4R
V-9502-3 ¹		5/16 (8)	4R
V-9502-4 ¹		5/16 (8)	5R
V-9502-5 ¹		3/8 (10)	5R
V-9502-6 ¹		1/2 (13)	8R
V-9502-90 ¹	V-3000-8012 Actuated Valves		
V-9502-91 ¹	V-3000-8001 Actuated Valves		
V-9502-15 ¹	V-3000-1 and V-3000-8012 Actuated Valves		
V-9502-95 ²	MP8000 Actuated VG2000 and VG7000 Series Valves		

V-9502 Pneumatic Valve Actuator Positioners

Code Number	Valve Type	Stem Diameter, in. (mm)	Diaphragm Size
V-9502-23 ¹	V-5252, V-5254, V-5462, V-5464, V-5652, V-5842, V-5844 Valves	All	All
V-9502-16 ¹	V-5210, V-5216, V-5230, V-5410, V-5416, V-5430, V-5810, V-7216, V-7416 Valves	All	4R, 5R, 8R
V-9502-76 ³	V-400 and V-500 Actuated Valves		
V-9502-8033 ¹	V-3000 Actuated V-7216 and V-7416 Valves		

1. Positioner kit includes positioner, interconnecting linkage, and mounting hardware (order positioner spring separately).
2. Positioner kit does not include positioner spring or mounting hardware (order positioner spring and mounting kit separately).
3. Positioner kit does not include positioner spring (order positioner spring separately).

The performance specifications are nominal and conform to acceptable industry standards. For applications at conditions beyond these specifications, consult the local Johnson Controls office. Johnson Controls shall not be liable for damages resulting from misapplication or misuse of its products. © 2019 Johnson Controls. www.johnsoncontrols.com

V-9502 Series Pneumatic Valve Actuator Positioners (Continued)

Positioner Springs for 3R, 4R, 5R, and 8R Pneumatic Valve Actuators; or Kieley & Mueller Actuator and Valve Assemblies Manufactured Prior to January, 1975

Code Number	Valve Stroke, in. (mm)
V-510-100	3/16 through 5/16 (5 through 8)
V-510-101	3/8 through 7/16 (10 through 11)
V-510-102	15/32 through 5/8 (12 through 16)
V-510-103	11/16 through 3/4 (17 through 19)
V-510-104	13/16 through 1-1/4 (21 through 32)
V-510-105	1-3/8 through 1-1/2 (35 through 38)
V-510-106	1-5/8 through 2 (41 through 51)
V-510-107	2-3/8 through 2-1/2 (60 through 64)

Positioner Springs for MP8000 Actuated VG2000 and VG7000 Series Valves

Code Number	Valve Stroke, in. (mm)	Positioner Spring Color Code
V-9502-610	5/16 (8)	Yellow
V-9502-611	1/2 (13)	Blue
V-9502-612	3/4 (19)	White
V-9502-613	1 (25)	Gray
V-9502-614	1-1/8 (29)	Green
V-9502-615	1-1/2 (38)	Red
MP8000-6002 ¹	All	All

1. Kit includes all mounting hardware and all six color-coded positioner springs.

Positioner Springs for V-400 and V-500 Actuated VG7000 Series Valves

Code Number	Valve Size, in.	Valve Stroke, in. (mm)
V-9502-8100	1/2 or 3/4	5/16 (8)
V-9502-8102	1 or 1-1/4	1/2 (13)
V-9502-8106	1-1/2 or 2	3/4 (19)

Positioner Springs for V-3000 Actuated VG7000 Series Valves

Code Number	Valve Stroke, in. (mm)	5/16 (8)	3/8 (10)	1/2 (13)	3/4 (19)
V-9502-6801	Spring Span, psig (kPa)	3.0 (21)		5.0 (34)	10.0 (70)
V-9502-6802		8.0 (55)		12.0 (83)	
V-9502-6803					4.0 (28)

Repair Information

If the V-9502 Series Pneumatic Valve Actuator Positioner fails to operate within its specifications, replace the unit. For a replacement positioner, contact the nearest Johnson Controls® representative.

Technical Specifications

V-9502 Series Pneumatic Valve Actuator Positioners		
Operating Span	Field Selectable from 3 to 13 psi (21 to 90 kPa) on 3R, 4R, 5R, 8R, and MP8000 Series Pneumatic Valve Actuators; Fixed on V-3000 Series Pneumatic Valve Actuators	
Starting Point	Field Adjustable from 2 to 12 psig (14 to 83 kPa)	
Supply Pressure	20 psig (138 kPa) Nominal; 25 psig (172 kPa) Maximum	
Air Consumption	5 scim (1.4 mL/s)	
Output Flow Capacity	With Dual Barbed Fitting	1,000 scim (273 mL/s)
	With 1/4 in. Fitting	1,600 scim (437 mL/s)
Air Connections	1/8 in. NPT Dual Barbed Fittings for 5/32 in. or 1/4 in. O.D. Poly tubing	
Ambient Operating Temperature Limits	-20°F to 150°F (-29°C to 66°C)	
Materials	Body	Die Cast Aluminum with Iridite Finish
	Cover	Noryl®
	Diaphragm	Fabric-Reinforced Rubber
Shipping Weight	2.0 lb (0.9 kg)	

The performance specifications are nominal and conform to acceptable industry standards. For applications at conditions beyond these specifications, consult the local Johnson Controls office. Johnson Controls shall not be liable for damages resulting from misapplication or misuse of its products. © 2019 Johnson Controls. www.johnsoncontrols.com

Positioner Springs for All Other V-3000 Actuated Valves Except VG7000 Series

Code Number	Valve Stroke, in. (mm)	5/16 (8)	3/8 (10)	1/2 (13)	3/4 (19)
V-9502-19	Spring Span, psig (kPa)	8.0 (55)	9.5 (65)	12.0 (83)	
V-9502-20		3.0 (21)	4.0 (28)	5.0 (34)	
V-9502-100				3.6 (25)	5.1 (35)
V-9502-101		4.3 (30)	5.2 (36)	7.0 (48)	10.6 (73)

Accessories/Maintenance Parts

Code Number	Item	Description
C-9506-1	A	Positioner Movement Complete (Less Items B and D)
	B	Positioner Springs (See the <i>Positioner Springs</i> Charts.)
	C	Diaphragm Assembly: Includes Diaphragm, Six Diaphragm Reinforcements, One Seat, Three Nuts, One Spring, Two Metal Balls, One Ball Retainer, Two Screws, and One Gasket
V-9502-600		For Old-Style Positioners with Air Connections on Three Sides
D-9502-611		For New-Style Positioners with Air Connections on One Side
D-9502-604	D	Positioner Operating Span Lever Arm Assembly

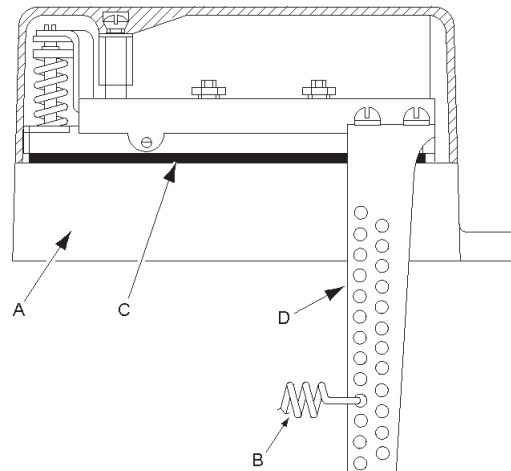

V-9502 Accessory and Maintenance Parts

V-9502 Series Pneumatic Valve Actuator Positioners (Continued)

Valve Strokes for All Valves Except Encapsulated Spring Models

Valve Size, in.	Valve Type	Valve Stroke, in. (mm)
1/2 and 3/4	VG7000 Series Valves	5/16 (8)
1 and 1-1/4	VG7000 Series Valves	1/2 (13)
1-1/2 and 2	VG7000 Series Valves	3/4 (19)
1/2 and 3/4	All Except V-3754, V-3974, V-4324, V-4440, and VG7000 Series Valves	5/16 (8)
1 and 1-1/4	All Except V-3754, V-3974, V-4324, V-4440, and VG7000 Series Valves	3/8 (10)
1/2 and 3/4	V-3754, V-3974, and V-4324 Valves	1/2 (13)
1/2 and 5/8	V-4440 Valves	11/16 (17)
1	V-3754, V-3974, and V-4324 Valves	3/4 (19)
1-1/2 and 2	All Angle, Globe, and Three-Way Mixing Valves Except V-3754, V-3974, V-4324, V-5254, V-5464, and V-5844	1/2 (13)
1-1/2 and 2	V-3754, V-3974, V-4324, V-5254, V-5464, and V-5844 Valves	3/4 (19)
2-1/2	Two-Way Normally Open (N.O.) and Normally Closed (N.C.) Valves	3/4 (19)
	Three-Way Mixing and Bypass Valves ¹	3/4 (19)
	Three-Way Mixing and Bypass Valves	9/16 (14)
3	Two-Way N.O. and N.C. Valves	7/8 (22) ² and 1-1/8 (29)
	Three-Way Mixing and Bypass Valves ¹	7/8 (22)
	Three-Way Mixing and Bypass Valves	13/16 (21)
4	Two-Way N.O. and N.C. Valves	1-1/8 (29)
	Three-Way Mixing and Bypass Valves ¹	1-1/8 (29)
	Three-Way Mixing and Bypass Valves	1 (25)
5	Two-Way N.O. and N.C. Valves	1-3/8 (35)
	Three-Way Mixing and Bypass Valves ¹	1-3/8 (35)
	Three-Way Mixing and Bypass Valves	1-3/16 (30)
6	Two-Way N.O. and N.C. Valves	1-1/2 (38)
	Three-Way Mixing and Bypass Valves ¹	1-1/2 (38)
	Three-Way Mixing and Bypass Valves	1-7/16 (37)
8	Two-Way N.O. and N.C. Valves	1-1/2 (38)
	Three-Way Mixing Valves	2 (51)

1. For V-5850, V-5852, and V-5820 Series valves only
2. With 4R top

Valve Strokes for V-5252, V-5254, V-5462, V-5464, V-5652, V-5842, and V-5844 Valves

Valve Size, in.	Valve Stroke, in. (mm)
1-1/4	3/8 (10)
1-1/2 and 2 ¹	1/2 (13)
2-1/2	3/4 (19)
3 (4R)	3/4 (19)
3 (5R and 8R)	1-1/8 (29)
3 (V-5652)	7/8 (22)
4	1-1/8 (29)
5	1-3/8 (35)
6	1-1/2 (38)

1. V-5254, V-5464, and V-5844 Series Valves have a stroke of 3/4 in. (19 mm).

Valve Strokes for V-5210, V-5216, V-5410, V-5416, V-5810, V-7216, and V-7416 Valves

Valve Size, in.	Valve Stroke, in. (mm)
1/2	5/16 (8)
3/4 and 1	3/8 (10)
1-1/4, 1-1/2, and 2	1/2 (13)
2-1/2	3/4 (19)
3 and 4	1-1/8 (29)

Valve Strokes for V-5230 and V-5430 Valves

Valve Size, in.	Valve Stroke, in. (mm)
1/2 and 3/4 ¹	5/16 (8)
1 and 1-1/4	3/8 (10)
1-1/2 and 2	1/2 (13)

1. Up to Cv = 4.7



WARNING This product is made of copper alloy, which contains lead. The product is therefore not to be used on drinking water.



WARNING This product can expose you to chemicals including lead, which is known to the State of California to cause cancer, birth defects, or other reproductive harm. For more information, go to www.P65Warnings.ca.gov.

WARNING: BRASS MAY CONTAIN LEAD

To fulfill our obligations towards Article 33, in accordance to the European REACH Regulation No 1907/2006 EC, we hereby inform you that this article contains the following Substances of Very High Concern mentioned on the Candidate list:

- Lead

J Series Electric Zone Valves — Two-Way Spring Open (Normally Open), On/Off Control

Description

This electric zone valve with forged brass body offers two-way spring open (normally open), on/off control for hot or chilled water applications.

Refer to the *J Series Electric Zone Valves Product Bulletin (LIT-977282)* for important product application information.

Features

- forged brass body and hard chrome-plated brass stem
- provides economical control of hot or chilled water for fan coil, baseboard radiator, and VAV reheat applications

- on/off control from a two-wire thermostat
- 300 psig system operating pressure
- 400 psig static pressure rating
- buna-N (standard temperature) or nitrile disk (high temperature) provides tight closeoff
- 1/2 in., 3/4 in., and 1 in. line sizes
- sweat, NPT, or inverted flare end connections
- actuator can be factory or field installed
- actuator snaps in place for easy removal and assembly during installation



Standard Closeoff

Selection Chart

Valve Model Code Number					Actuator Model Code Number			
					G Style Actuators have Standard Pressure Closeoff H Style Actuators have High Pressure Closeoff			
Standard Temp	High Temp	Size, in.	Cv	Closeoff, psig	Standard Temperature Rating: 200°F (93°C) Fluid, 104°F (40°C) Ambient		High Temperature Rating: 250°F (121°C) Fluid, 15 psig Steam, 169°F (76°C) Ambient	
					24 VAC, 60 Hz	120 VAC, 60 Hz	24 VAC, 60 Hz	120 VAC, 60 Hz
					JG23A020 JH23A020	JG23B020 JH23B020	JG24A020 JH24A020	JG24B020 JH24B020
Sweat Connections — Standard Pressure Closeoff								
JT2211	JS2211	1/2	1.0	60	JT2211G23A020	JT2211G23B020	JS2211G24A020	JS2211G24B020
JT2212	JS2212	1/2	2.5	40	JT2212G23A020	JT2212G23B020	JS2212G24A020	JS2212G24B020
JT2213	JS2213	1/2	3.5	25	JT2213G23A020	JT2213G23B020	JS2213G24A020	JS2213G24B020
JT2312	JS2312	3/4	2.5	40	JT2312G23A020	JT2312G23B020	JS2312G24A020	JS2312G24B020
JT2313	JS2313	3/4	3.5	25	JT2313G23A020	JT2313G23B020	JS2313G24A020	JS2313G24B020
JT2417	JS2417	1	8.0	17	JT2417G23A020	JT2417G23B020	JS2417G24A020	JS2417G24B020
JT2517	JS2517	1-1/4	8.0	17	JT2517G23A020	JT2517G23B020	JS2517G24A020	JS2517G24B020
NPT Connections — Standard Pressure Closeoff								
JT2221	JS2221	1/2	1.0	60	JT2221G23A020	JT2221G23B020	JS2221G24A020	JS2221G24B020
JT2222	JS2222	1/2	2.5	40	JT2222G23A020	JT2222G23B020	JS2222G24A020	JS2222G24B020
JT2223	JS2223	1/2	3.5	25	JT2223G23A020	JT2223G23B020	JS2223G24A020	JS2223G24B020
JT2322	JS2322	3/4	2.5	40	JT2322G23A020	JT2322G23B020	JS2322G24A020	JS2322G24B020
JT2323	JS2323	3/4	3.5	25	JT2323G23A020	JT2323G23B020	JS2323G24A020	JS2323G24B020
JT2427	JS2427	1	8.0	17	JT2427G23A020	JT2427G23B020	JS2427G24A020	JS2427G24B020
Inverted Flare Connections — Standard Pressure Closeoff								
JT2343	JS2343	3/4	3.5	25	JT2343G23A020	JT2343G23B020	JS2343G24A020	JS2343G24B020
Sweat Connections — High Pressure Closeoff								
JT2211	JS2211	1/2	1.0	75	JT2211H23A020	JT2211H23B020	JS2211H24A020	JS2211H24B020
JT2212	JS2212	1/2	2.5	50	JT2212H23A020	JT2212H23B020	JS2212H24A020	JS2212H24B020
JT2213	JS2213	1/2	3.5	30	JT2213H23A020	JT2213H23B020	JS2213H24A020	JS2213H24B020
JT2312	JS2312	3/4	2.5	50	JT2312H23A020	JT2312H23B020	JS2312H24A020	JS2312H24B020
JT2313	JS2313	3/4	3.5	30	JT2313H23A020	JT2313H23B020	JS2313H24A020	JS2313H24B020
JT2417	JS2417	1	8.0	20	JT2417H23A020	JT2417H23B020	JS2417H24A020	JS2417H24B020
JT2517	JS2517	1-1/4	8.0	20	JT2517H23A020	JT2517H23B020	JS2517H24A020	JS2517H24B020
NPT Connections — High Pressure Closeoff								
JT2221	JT2221	1/2	1.0	75	JT2221H23A020	JT2221H23B020	JS2221H24A020	JS2221H24B020
JT2222	JT2222	1/2	2.5	50	JT2222H23A020	JT2222H23B020	JS2222H24A020	JS2222H24B020
JT2223	JT2223	1/2	3.5	30	JT2223H23A020	JT2223H23B020	JS2223H24A020	JS2223H24B020
JT2322	JT2322	3/4	2.5	50	JT2322H23A020	JT2322H23B020	JS2322H24A020	JS2322H24B020
JT2323	JT2323	3/4	3.5	30	JT2323H23A020	JT2323H23B020	JS2323H24A020	JS2323H24B020
JT2427	JT2427	1	8.0	20	JT2427H23A020	JT2427H23B020	JS2427H24A020	JS2427H24B020
Inverted Flare Connections — High Pressure Closeoff								
JT2343	JS2343	3/4	3.5	30	JT2343H23A020	JT2343H23B020	JS2343H24A020	JS2343H24B020

The performance specifications are nominal and conform to acceptable industry standards. For applications at conditions beyond these specifications, consult the local Johnson Controls office. Johnson Controls shall not be liable for damages resulting from misapplication or misuse of its products. © 2019 Johnson Controls. www.johnsoncontrols.com

J Series Electric Zone Valves — Two-Way Spring Open (Normally Open), On/Off Control (Continued)

Repair Parts

Inverted Flare Fittings

Code Number	Description	Length, in. (mm)
J647-601	For 1/2 in. (5/8 in. O.D.) Copper Tubing	15/16 (24)
J647-602	For 1/2 in. (5/8 in. O.D.) Copper Tubing	1-11/16 (43)
J647-603	For 1/2 in. (5/8 in. O.D.) Copper Tubing	3 (76)
J647-604	For 3/4 in. (7/8 in. O.D.) Copper Tubing	1-27/32 (47)
J647-605	For 1/2 in. (5/8 in. O.D.) Copper Tubing	1-15/16 (49)
J647-606	For 1 in. (1-1/8 in. O.D.) Copper Tubing	2-3/8 (60)



J647-601 J647-602 J647-603 J647-604 J647-605 J647-606
Inverted Flare Fittings

Technical Specifications

J Series Electric Zone Valves — Two-Way Spring Open (Normally Open), On/Off Control			
Service¹		Hot Water, Chilled Water, and 50/50 Glycol Solutions for HVAC Systems	
Fluid Temperature Limits	Water	JT Series	32°F to 200°F (0°C to 93°C)
		JS Series	32°F to 250°F (0°C to 121°C)
	Steam	JT Series	Not Rated for Steam Service
		JS Series	15 psig (103 kPa) Saturated Steam
Valve Body Pressure Rating		300 psig (2,067 kPa)	
Leakage		Bubble-Tight Shutoff	
Ambient Operating Temperature Limits		JT Series	32°F to 104°F (0°C to 40°C)
		JS Series	32°F to 169°F (0°C to 76°C)
Cycle Time		Power Stroke 9 to 11 Seconds, Spring Return 4 to 5 Seconds	
Control Signal		24 VAC or 120 VAC, 60 Hz, Two-Wire On/Off	
Power Requirements		7 VA	
Electrical Connection		18 in. (457 mm) Wire Leads	
Materials	Body		Brass
	Stem		Brass (Hard Chrome Plated)
	Base Plate and Bearing Plate		Stainless Steel
	Actuator Housing		Stainless Steel
	Actuator Cover		Aluminum
	Valve Paddle	JT Series	Buna-N Rubber
		JS Series	Saturated Nitrile
Stem Seals		Viton® O-Rings	

1. Refer to the VDI 2035 Guideline for recommended proper water treatment.



WARNING

This product is made of copper alloy, which contains lead. The product is therefore not to be used on drinking water.



WARNING

This product can expose you to chemicals including lead, which is known to the State of California to cause cancer, birth defects, or other reproductive harm. For more information, go to www.P65Warnings.ca.gov.

WARNING: BRASS MAY CONTAIN LEAD

To fulfill our obligations towards Article 33, in accordance to the European REACH Regulation No 1907/2006 EC, we hereby inform you that this article contains the following Substances of Very High Concern mentioned on the Candidate list:

- Lead

J Series Electric Zone Valves — Two-Way Spring Closed (Normally Closed), On/Off Control

Description

This electric zone valve with forged brass body offers two-way spring closed (normally closed), on/off control for hot or chilled water applications.

Refer to the *J Series Electric Zone Valves Product Bulletin (LIT-977282)* for important product application information.

Features

- forged brass body and hard chrome-plated brass stem
- on/off control from a two-wire thermostat
- provides economical control of hot or chilled water for fan coil, baseboard radiator, and VAV reheat applications
- 300 psig system operating pressure
- 400 psig static pressure rating
- buna-N (standard temperature) or nitrile disk (high temperature) provides tight closeoff
- 1/2 in., 3/4 in., and 1 in. line sizes

- sweat, NPT, or inverted flare end connections
- actuator can be factory or field installed
- actuator snaps in place for easy removal and assembly during installation

WARNING

This product is made of copper alloy, which contains lead. The product is therefore not to be used on drinking water.

WARNING

This product can expose you to chemicals including lead, which is known to the State of California to cause cancer, birth defects, or other reproductive harm. For more information, go to www.P65Warnings.ca.gov.

WARNING: BRASS MAY CONTAIN LEAD

To fulfill our obligations towards Article 33, in accordance to the European REACH Regulation No 1907/2006 EC, we hereby inform you that this article contains the following Substances of Very High Concern mentioned on the Candidate list:

- Lead



High Closeoff



Standard Closeoff

Selection Chart

J Series Electric Zone Valves — Two-Way Spring Closed (Normally Closed), On/Off Control (Part 1 of 2)

Valve Model Code Number					Actuator Model Code Number			
					G Style Actuators have Standard Pressure Closeoff			
					H Style Actuators have High Pressure Closeoff			
					Standard Temperature Rating: 200°F (93°C) Fluid, 104°F (40°C) Ambient		High Temperature Rating: 250°F (121°C) Fluid, 15 psig Steam, 169°F (76°C) Ambient	
Standard Temp	High Temp	Size, in.	Cv	Closeoff, psig	24 VAC, 60 Hz	120 VAC, 60 Hz	24 VAC, 60 Hz	120 VAC, 60 Hz
					JG13A020 JH13A020	JG13B020 JH13B020	JG14A020 JH14A020	JG14B020 JH14B020
Sweat Connections — Standard Pressure Closeoff								
JT2211	JS2211	1/2	1.0	60	JT2211G13A020	JT2211G13B020	JS2211G14A020	JS2211G14B020
JT2212	JS2212	1/2	2.5	40	JT2212G13A020	JT2212G13B020	JS2212G14A020	JS2212G14B020
JT2213	JS2213	1/2	3.5	25	JT2213G13A020	JT2213G13B020	JS2213G14A020	JS2213G14B020
JT2312	JS2312	3/4	2.5	40	JT2312G13A020	JT2312G13B020	JS2312G14A020	JS2312G14B020
JT2313	JS2313	3/4	3.5	25	JT2313G13A020	JT2313G13B020	JS2313G14A020	JS2313G14B020
JT2417	JS2417	1	8.0	17	JT2417G13A020	JT2417G13B020	JS2417G14A020	JS2417G14B020
JT2517	JS2517	1-1/4	8.0	17	JT2517G13A020	JT2517G13B020	JS2517G14A020	JS2517G14B020
NPT Connections — Standard Pressure Closeoff								
JT2221	JS2221	1/2	1.0	60	JT2221G13A020	JT2221G13B020	JS2221G14A020	JS2221G14B020
JT2222	JS2222	1/2	2.5	40	JT2222G13A020	JT2222G13B020	JS2222G14A020	JS2222G14B020
JT2223	JS2223	1/2	3.5	25	JT2223G13A020	JT2223G13B020	JS2223G14A020	JS2223G14B020
JT2322	JS2322	3/4	2.5	40	JT2322G13A020	JT2322G13B020	JS2322G14A020	JS2322G14B020
JT2323	JS2323	3/4	3.5	25	JT2323G13A020	JT2323G13B020	JS2323G14A020	JS2323G14B020
JT2427	JS2427	1	8.0	17	JT2427G13A020	JT2427G13B020	JS2427G14A020	JS2427G14B020
Inverted Flare Connections — Standard Pressure Closeoff								
JT2343	JS2343	3/4	3.5	25	JT2343G13A020	JT2343G13B020	JS2343G14A020	JS2343G14B020
Sweat Connections — High Pressure Closeoff								
JT2211	JS2211	1/2	1.0	75	JT2211H13A020	JT2211H13B020	JS2211H14A020	JS2211H14B020
JT2212	JS2212	1/2	2.5	50	JT2212H13A020	JT2212H13B020	JS2212H14A020	JS2212H14B020
JT2213	JS2213	1/2	3.5	30	JT2213H13A020	JT2213H13B020	JS2213H14A020	JS2213H14B020
JT2312	JS2312	3/4	2.5	50	JT2312H13A020	JT2312H13B020	JS2312H14A020	JS2312H14B020
JT2313	JS2313	3/4	3.5	30	JT2313H13A020	JT2313H13B020	JS2313H14A020	JS2313H14B020
JT2417	JS2417	1	8.0	20	JT2417H13A020	JT2417H13B020	JS2417H14A020	JS2417H14B020
JT2517	JS2517	1-1/4	8.0	20	JT2517H13A020	JT2517H13B020	JS2517H14A020	JS2517H14B020

The performance specifications are nominal and conform to acceptable industry standards. For applications at conditions beyond these specifications, consult the local Johnson Controls office. Johnson Controls shall not be liable for damages resulting from misapplication or misuse of its products. © 2019 Johnson Controls www.johnsoncontrols.com

J Series Electric Zone Valves — Two-Way Spring Closed (Normally Closed), On/Off Control (Continued)

J Series Electric Zone Valves — Two-Way Spring Closed (Normally Closed), On/Off Control (Part 2 of 2)

Valve Model Code Number					Actuator Model Code Number			
					G Style Actuators have Standard Pressure Closeoff H Style Actuators have High Pressure Closeoff			
					Standard Temperature Rating: 200°F (93°C) Fluid, 104°F (40°C) Ambient		High Temperature Rating: 250°F (121°C) Fluid, 15 psig Steam, 169°F (76°C) Ambient	
Standard Temp	High Temp	Size, in.	Cv	Closeoff, psig	24 VAC, 60 Hz JG13A020 JH13A020	120 VAC, 60 Hz JG13B020 JH13B020	24 VAC, 60 Hz JG14A020 JH14A020	120 VAC, 60 Hz JG14B020 JH14B020
NPT Connections — High Pressure Closeoff								
JT2221	JS2221	1/2	1.0	75	JT2221H13A020	JT2221H13B020	JS2221H14A020	JS2221H14B020
JT2222	JS2222	1/2	2.5	50	JT2222H13A020	JT2222H13B020	JS2222H14A020	JS2222H14B020
JT2223	JS2223	1/2	3.5	30	JT2223H13A020	JT2223H13B020	JS2223H14A020	JS2223H14B020
JT2322	JS2322	3/4	2.5	50	JT2322H13A020	JT2322H13B020	JS2322H14A020	JS2322H14B020
JT2323	JS2323	3/4	3.5	30	JT2323H13A020	JT2323H13B020	JS2323H14A020	JS2323H14B020
JT2427	JS2427	1	8.0	20	JT2427H13A020	JT2427H13B020	JS2427H14A020	JS2427H14B020
Inverted Flare Connections — High Pressure Closeoff								
JT2343	JS2343	3/4	3.5	30	JT2343H13A020	JT2343H13B020	JS2343H14A020	JS2343H14B020

Repair Parts

Inverted Flare Fittings

Code Number	Description	Length, in. (mm)
J647-601	For 1/2 in. (5/8 in. O.D.) Copper Tubing	15/16 (24)
J647-602	For 1/2 in. (5/8 in. O.D.) Copper Tubing	1-11/16 (43)
J647-603	For 1/2 in. (5/8 in. O.D.) Copper Tubing	3 (76)
J647-604	For 3/4 in. (7/8 in. O.D.) Copper Tubing	1-27/32 (47)
J647-605	For 1/2 in. (5/8 in. O.D.) Copper Tubing	1-15/16 (49)
J647-606	For 1 in. (1-1/8 in. O.D.) Copper Tubing	2-3/8 (60)



J647-601 J647-602 J647-603 J647-604 J647-605 J647-606
Inverted Flare Fittings

Technical Specifications

J Series Electric Zone Valves — Two-Way Spring Closed (Normally Closed), On/Off Control				
Service ¹		Hot Water, Chilled Water, and 50/50 Glycol Solutions for HVAC Systems		
Fluid Temperature Limits	Water	JT Series	32°F to 200°F (0°C to 93°C)	
		JS Series	32°F to 250°F (0°C to 121°C)	
	Steam	JT Series	Not Rated for Steam Service	
		JS Series	15 psig (103 kPa) Saturated Steam	
Valve Body Pressure Rating		300 psig (2,067 kPa)		
Leakage		Bubble-Tight Shutoff		
Ambient Operating Temperature Limits	JT Series	32°F to 104°F (0°C to 40°C)		
	JS Series	32°F to 169°F (0°C to 76°C)		
Cycle Time		Power Stroke 9 to 11 Seconds, Spring Return 4 to 5 Seconds		
Control Signal		24 VAC or 120 VAC, 60 Hz, Two-Wire On/Off		
Power Requirements		7 VA		
Electrical Connection		18 in. (457 mm) Wire Leads		
Materials	Body		Brass	
	Stem		Brass (Hard Chrome Plated)	
	Base Plate and Bearing Plate		Stainless Steel	
	Actuator Housing		Stainless Steel	
	Actuator Cover		Aluminum	
	Valve Paddle	JT Series	Buna-N Rubber	
		JS Series	Saturated Nitrile	
Stem Seals		Viton® O-Rings		

1. Refer to the VDI 2035 Guideline for recommended proper water treatment.

J Series Electric Zone Valves — Two-Way Spring Open (Normally Open), Modulating Control

Description

This electric zone valve with forged brass body offers two-way spring open (normally open), modulating control for hot or chilled water applications.

Refer to the *J Series Electric Zone Valves Product Bulletin (LIT-977282)* for important product application information.

WARNING

This product is made of copper alloy, which contains lead. The product is therefore not to be used on drinking water.

Features

- economical control of hot or chilled water (up to 50% glycol) for fan coil, baseboard radiator, and VAV reheat applications
- 0 VDC to 10 VDC proportional and three-wire floating control
- 32°F to 200°F (0°C to 93°C) fluid temperature rating
- 32°F to 125°F (0°C to 52°C) ambient temperature rating
- 300 psig static pressure rating
- 20 VAC to 30 VAC 50/60 Hz
- forged brass body



JM Series Two-Way Spring-Return Modulating Zone Valve

Selection Chart

Valve	Size, in.	Cv	Closeoff, psig	Actuator	
				Three-Wire Floating JT13A000	0 to 10 VDC Proportional JP13A000
Two-Way — Sweat Connections					
JM2211	1/2	1	50	JM2211T23A000	JM2211P23A000
JM2212	1/2	2	50	JM2212T23A000	JM2212P23A000
JM2213	1/2	4	35	JM2213T23A000	JM2213P23A000
JM2312	3/4	2	50	JM2312T23A000	JM2312P23A000
JM2313	3/4	4	35	JM2313T23A000	JM2313P23A000
JM2317	3/4	7.5	35	JM2317T23A000	JM2317P23A000
JM2413	1	4	35	JM2413T23A000	JM2413P23A000
JM2417	1	8	35	JM2417T23A000	JM2417P23A000
JM2517	1-1/4	8	35	JM2517T23A000	JM2517P23A000
Two-Way — NPT Connections					
JM2221	1/2	1	50	JM2221T23A000	JM2221P23A000
JM2222	1/2	2	50	JM2222T23A000	JM2222P23A000
JM2223	1/2	4	35	JM2223T23A000	JM2223P23A000
JM2322	3/4	2	50	JM2322T23A000	JM2322P23A000
JM2323	3/4	4	35	JM2323T23A000	JM2323P23A000
JM2327	3/4	7.5	35	JM2327T23A000	JM2327P23A000
JM2427	1	8	35	JM2427T23A000	JM2427P23A000

Repair Information

If the J Series Zone Valve fails to operate within its specifications, replace the valve body, actuator, or entire assembly. For replacement parts, contact the nearest Johnson Controls® representative.

WARNING

This product can expose you to chemicals including lead, which is known to the State of California to cause cancer, birth defects, or other reproductive harm. For more information, go to www.P65Warnings.ca.gov.

Note: Actuators and valve bodies can be ordered separately using the actuator and valve code numbers shown. JM Series Modulating Three-Way Electric Zone Valves must be piped in a mixing configuration only.

Technical Specifications

J Series Electric Zone Valves — Two-Way Spring Open (Normally Open), Modulating Control													
Service¹	Hot Water, Chilled Water, and 50/50 Glycol Solutions for HVAC Systems												
Fluid Temperature Limits	<table border="1"> <tr> <td>Water</td> <td>32°F to 200°F (0°C to 93°C)</td> </tr> <tr> <td>Steam</td> <td>Not Rated for Steam Service</td> </tr> </table>	Water	32°F to 200°F (0°C to 93°C)	Steam	Not Rated for Steam Service								
Water	32°F to 200°F (0°C to 93°C)												
Steam	Not Rated for Steam Service												
Valve Body Pressure Rating	300 psig (2,067 kPa)												
Leakage	0.01% of Maximum Flow per ANSI/FCI 70-2 Class IV												
Ambient Operating Temperature Limits	32°F to 125°F (0°C to 52°C)												
Cycle Time	Full Close to Full Open 150 Seconds												
Control Signal	<table border="1"> <tr> <td>T Type Actuator</td> <td>24 VAC, 60 Hz, Three-Wire Floating Control</td> </tr> <tr> <td>P Type Actuator</td> <td>0 VDC to 10 VDC (1 VDC to 9 VDC Actual) Factory Setting, 0 VDC to 5 VDC, 5 VDC to 10 VDC Jumper Selectable</td> </tr> </table>	T Type Actuator	24 VAC, 60 Hz, Three-Wire Floating Control	P Type Actuator	0 VDC to 10 VDC (1 VDC to 9 VDC Actual) Factory Setting, 0 VDC to 5 VDC, 5 VDC to 10 VDC Jumper Selectable								
T Type Actuator	24 VAC, 60 Hz, Three-Wire Floating Control												
P Type Actuator	0 VDC to 10 VDC (1 VDC to 9 VDC Actual) Factory Setting, 0 VDC to 5 VDC, 5 VDC to 10 VDC Jumper Selectable												
Control Action	P Type Actuator Factory Setting: Direct Acting Valve Opens Port B as Signal Increases. Jumper Selectable												
Power Requirements	1.6 VA												
Electrical Connection	Terminal Block												
Materials	<table border="1"> <tr> <td>Body</td> <td>Brass</td> </tr> <tr> <td>Stem</td> <td>Brass (Hard Chrome Plated)</td> </tr> <tr> <td>Base Plate and Bearing Plate</td> <td>Stainless Steel</td> </tr> <tr> <td>Actuator Housing</td> <td>High-Temperature Plastic</td> </tr> <tr> <td>Valve Plug</td> <td>High-Temperature Thermoplastic Rubber</td> </tr> <tr> <td>Stem Seals</td> <td>Viton™ O-Rings</td> </tr> </table>	Body	Brass	Stem	Brass (Hard Chrome Plated)	Base Plate and Bearing Plate	Stainless Steel	Actuator Housing	High-Temperature Plastic	Valve Plug	High-Temperature Thermoplastic Rubber	Stem Seals	Viton™ O-Rings
Body	Brass												
Stem	Brass (Hard Chrome Plated)												
Base Plate and Bearing Plate	Stainless Steel												
Actuator Housing	High-Temperature Plastic												
Valve Plug	High-Temperature Thermoplastic Rubber												
Stem Seals	Viton™ O-Rings												

1. Refer to the VDI 2035 Guideline for recommended proper water treatment.

WARNING: BRASS MAY CONTAIN LEAD

To fulfill our obligations towards Article 33, in accordance to the European REACH Regulation No 1907/2006 EC, we hereby inform you that this article contains the following Substances of Very High Concern mentioned on the Candidate list:

- Lead

J Series Electric Zone Valves — Three-Way Spring Return, On/Off Control

Description

J Series Electric Zone Valves accurately control the flow of saturated steam, hot water, and chilled water through coils and heat exchanges of all types.

Refer to the *J Series Electric Zone Valves Product Bulletin (LIT-977282)* for important product application information.

Features

- forged brass body and hard chrome-plated brass stem
- provides economical control of hot or chilled water for fan coil, baseboard radiator, and VAV reheat applications
- On/Off control from a two-wire thermostat
- 300 psig system operating pressure
- 400 psig static pressure rating
- can be piped for mixing or diverting configuration



Standard Closeoff

- buna-N (standard temperature) or nitrile disk (high temperature) provides tight closeoff
- 1/2 in., 3/4 in., and 1 in. line sizes



High Closeoff

- sweat, NPT, or inverted flare end connections
- actuator can be factory or field installed
- actuator snaps in place for easy removal and assembly during installation

Selection Chart

Note: Three-way valves are shipped from the factory in the normally closed configuration (Port B closed); for normally open configuration, simply turn the valve around during installation.

Valve Model Code Number					Actuator Model Code Number G Style Actuators have Standard Pressure Closeoff H Style Actuators have High Pressure Closeoff			
Standard Temp	High Temp	Size, in.	Cv	Closeoff, psig	Standard Temperature Rating: 200°F (93°C) Fluid, 104°F (40°C) Ambient		High Temperature Rating: 250°F (121°C) Fluid, 15 psig Steam, 169°F (76°C) Ambient	
					24 VAC, 60 Hz	120 VAC, 60 Hz	24 VAC, 60 Hz	120 VAC, 60 Hz
					JG13A020 JH13A020	JG13B020 JH13B020	JG14A020 JH14A020	JG14B020 JH14B020
Sweat Connections — Standard Pressure Closeoff								
JT3213	JS3213	1/2	4.0	25	JT3213G13A020	JT3213G13B020	JS3213G14A020	JS3213G14B020
JT3315	JS3315	3/4	5.0	20	JT3315G13A020	JT3315G13B020	JS3315G14A020	JS3315G14B020
JT3417	JS3417	1	8.0	17	JT3417G13A020	JT3417G13B020	JS3417G14A020	JS3417G14B020
JT3517	JS3517	1-1/4	8.0	17	JT3517G13A020	JT3517G13B020	JS3517G14A020	JS3517G14B020
NPT Connections — Standard Pressure Closeoff								
JT3223	JS3223	1/2	4.0	25	JT3223G13A020	JT3223G13B020	JS3223G14A020	JS3223G14B020
JT3325	JS3325	3/4	5.0	20	JT3325G13A020	JT3325G13B020	JS3325G14A020	JS3325G14B020
JT3427	JS3427	1	8.0	17	JT3427G13A020	JT3427G13B020	JS3427G14A020	JS3427G14B020
Inverted Flare Connections — Standard Pressure Closeoff								
JT3343	JS3343	3/4	4.0	25	JT3343G13A020	JT3343G13B020	JS3343G14A020	JS3343G14B020
Sweat Connections — High Pressure Closeoff								
JT3213	JS3213	1/2	4.0	30	JT3213H13A020	JT3213H13B020	JS3213H14A020	JS3213H14B020
JT3315	JS3315	3/4	5.0	25	JT3315H13A020	JT3315H13B020	JS3315H14A020	JS3315H14B020
JT3417	JS3417	1	8.0	20	JT3417H13A020	JT3417H13B020	JS3417H14A020	JS3417H14B020
JT3517	JS3517	1-1/4	8.0	20	JT3517H13A020	JT3517H13B020	JS3517H14A020	JS3517H14B020
NPT Connections — High Pressure Closeoff								
JT3223	JS3223	1/2	4.0	30	JT3223H13A020	JT3223H13B020	JS3223H14A020	JS3223H14B020
JT3325	JS3325	3/4	5.0	25	JT3325H13A020	JT3325H13B020	JS3325H14A020	JS3325H14B020
JT3427	JS3427	1	8.0	20	JT3427H13A020	JT3427H13B020	JS3427H14A020	JS3427H14B020
Inverted Flare Connections — High Pressure Closeoff								
JT3343	JS3343	3/4	4.0	30	JT3343H13A020	JT3343H13B020	JS3343H14A020	JS3343H14B020

J Series Electric Zone Valves — Three-Way Spring Return, On/Off Control (Continued)

Repair Parts

Inverted Flare Fittings

Code Number	Description	Length, in. (mm)
J647-601	For 1/2 in. (5/8 in. O.D.) Copper Tubing	15/16 (24)
J647-602	For 1/2 in. (5/8 in. O.D.) Copper Tubing	1-11/16 (43)
J647-603	For 1/2 in. (5/8 in. O.D.) Copper Tubing	3 (76)
J647-604	For 3/4 in. (7/8 in. O.D.) Copper Tubing	1-27/32 (47)
J647-605	For 1/2 in. (5/8 in. O.D.) Copper Tubing	1-15/16 (49)
J647-606	For 1 in. (1-1/8 in. O.D.) Copper Tubing	2-3/8 (60)



J647-601 J647-602 J647-603 J647-604 J647-605 J647-606
Inverted Flare Fittings

Technical Specifications

J Series Electric Zone Valves — Three-Way Spring Return, On/Off Control			
Service¹		Hot Water, Chilled Water, and 50/50 Glycol Solutions for HVAC Systems	
Fluid Temperature Limits	Water	JT Series 32°F to 200°F (0°C to 93°C)	
		JS Series 32°F to 250°F (0°C to 121°C)	
	Steam	JT Series Not Rated for Steam Service	
		JS Series 15 psig (103 kPa) Saturated Steam	
Valve Body Pressure Rating		300 psig (2,067 kPa)	
Leakage		Bubble-Tight Shutoff	
Ambient Operating Temperature Limits	JT Series	32°F to 104°F (0°C to 40°C)	
	JS Series	32°F to 169°F (0°C to 76°C)	
Cycle Time		Power Stroke 9 to 11 Seconds, Spring Return 4 to 5 Seconds	
Control Signal		24 VAC or 120 VAC, 60 Hz, Two-Wire On/Off	
Power Requirements		7 VA	
Electrical Connection		18 in. (457 mm) Wire Leads	
Materials	Body	Brass	
	Stem	Brass (Hard Chrome Plated)	
	Base Plate and Bearing Plate	Stainless Steel	
	Actuator Housing	Stainless Steel	
	Actuator Cover	Aluminum	
	Valve Paddle	JT Series	Buna-N Rubber
		JS Series	Saturated Nitrile
Stem Seals	Viton® O-Rings		

1. Refer to the VDI 2035 Guideline for recommended proper water treatment.



WARNING This product is made of copper alloy, which contains lead. The product is therefore not to be used on drinking water.



WARNING This product can expose you to chemicals including lead, which is known to the State of California to cause cancer, birth defects, or other reproductive harm. For more information, go to www.P65Warnings.ca.gov.

WARNING: BRASS MAY CONTAIN LEAD

To fulfill our obligations towards Article 33, in accordance to the European REACH Regulation No 1907/2006 EC, we hereby inform you that this article contains the following Substances of Very High Concern mentioned on the Candidate list:

- Lead

J Series Electric Zone Valves for Assembly in the Field

Description

J Series Electric Zone Valves accurately control the flow of saturated steam, hot water, and chilled water through coils and heat exchangers of all types, in a wide range of HVAC applications. The spring-return, two-position design with synchronous motor has proven reliable in millions of installations worldwide. The actuator can be removed from the valve quickly and easily, simplifying installation and servicing. No special linkage kit or commissioning is required.

Refer to the *J Series Zone Valves Product Bulletin (LIT-977282)* for important product application information.

Features

- quick and simple actuator removal eases installation and provides quick actuator replacement during service
- bubble-tight shutoff conserves energy and accurately controls zone temperature for increased comfort

- high closeoff pressure actuator option satisfies demanding requirements of high-rise buildings and high-pressure pumping systems
- interchangeable actuators allow field conversion from normally open to normally closed without re-piping
- choice of end connections provides increased versatility and replacement capability

Repair Information

If the J Series Zone Valve fails to operate within its specifications, replace the valve body, actuator, or entire assembly. For replacement parts, contact the nearest Johnson Controls® representative.



J Series Electric Zone Valve

Selection Charts

J Series On/Off Valves — Standard Closeoff (Part 1 of 2)

Size, in.	Cv	Closeoff, psig	Valve — End Connections			Actuators			
			NPT	Sweat	Inverted Flare	AC 24 V	AC 120 V	AC 208 V	AC 230 V
Two-Way, Spring Closed, Standard Temperature (32 to 200°F, 32 to 104°F Ambient)									
1/2	1	60	JT2221	JT2211		JG13A020	JG13B020	JG13D020	JG13U020
	2.5	40	JT2222	JT2212					
	3.5	25	JT2223	JT2213					
3/4	2.5	40	JT2322	JT2312		JG13A020	JG13B020	JG13D020	JG13U020
	3.5	25	JT2323	JT2313	JT2343				
1	8	17	JT2427	JT2417		JG13A020	JG13B020	JG13D020	JG13U020
1-1/4	8	17		JT2515					
Two-Way, Spring Open, Standard Temperature (32 to 200°F, 32 to 104°F Ambient)									
1/2	1	60	JT2221	JT2211		JG23A020	JG23B020	JG23D020	JG23U020
	2.5	40	JT2222	JT2212					
	3.5	25	JT2223	JT2213					
3/4	2.5	40	JT2322	JT2312		JG23A020	JG23B020	JG23D020	JG23U020
	3.5	25	JT2323	JT2313	JT2343				
1	8	17	JT2427	JT2417		JG23A020	JG23B020	JG23D020	JG23U020
1-1/4	8	17		JT2515					
Three-Way, Spring Return Port B Closed, Standard Temperature (32 to 200°F, 32 to 104°F Ambient)									
1/2	4	30	JT3223	JT3213		JG13A020	JG13B020	JG13D020	JG13U020
3/4	5	25	JT3325	JT3315	JT3343				
1	8	20	JT3427	JT3417					
1-1/4	8	20		JT3517		JG13A020	JG13B020	JG13D020	JG13U020
Two-Way, Spring Closed, High Temperature (32 to 250°F, 15 psig Steam, 32 to 169°F Ambient)									
1/2	1	60	JS2221	JS2211		JG14A020	JG14B020		
	2.5	40	JS2222	JS2212					
	3.5	25	JS2223	JS2213					
3/4	2.5	40	JS2322	JS2312		JG14A020	JG14B020		
	3.5	25	JS2323	JS2313	JS2343				
1	8	17	JS2427	JS2417		JG14A020	JG14B020		
1-1/4	8	17		JS2515					

J Series Electric Zone Valves for Assembly in the Field (Continued)

J Series On/Off Valves — Standard Closeoff (Part 2 of 2)

Size, in.	Cv	Closeoff, psig	Valve — End Connections			Actuators			
			NPT	Sweat	Inverted Flare	AC 24 V	AC 120 V	AC 208 V	AC 230 V
Two-Way, Spring Open, High Temperature (32 to 250°F, 15 psig Steam, 32 to 169°F Ambient)									
1/2	1	60	JS2221	JS2211		JG24A020	JG24B020		
	2.5	40	JS2222	JS2212					
	3.5	25	JS2223	JS2213					
3/4	2.5	40	JS2322	JS2312					
	3.5	25	JS2323	JS2313	JS2343				
1	8	17	JS2427	JS2417					
1-1/4	8	17		JS2515					
Three-Way, Spring Return Port B Closed, High Temperature (32 to 250°F, 15 psig Steam, 32 to 169°F Ambient)									
1/2	4	30	JS3223	JS3213		JG14A020	JG14B020		
3/4	5	25	JS3325	JS3315	JS3343				
1	8	20	JS3427	JS3417					
1-1/4	8	20		JS3517					

J Series On/Off Valves — High Closeoff

Size, in.	Cv	Closeoff, psig	Valve — End Connections			Actuators	
			NPT	Sweat	Inverted Flare	AC 24 V	AC 120 V
Two-Way, Spring Closed, Standard Temperature (32 to 200°F, 32 to 104°F Ambient)							
1/2	1	75	JT2221	JT2211		JH13A020	JH13B020
	2.5	50	JT2222	JT2212			
	3.5	30	JT2223	JT2213			
3/4	2.5	50	JT2322	JT2312			
	3.5	30	JT2323	JT2313	JT2343		
1	8	20	JT2427	JT2417			
1-1/4	8	20		JT2515			
Two-Way, Spring Open, Standard Temperature (32 to 200°F, 32 to 104°F Ambient)							
1/2	1	75	JT2221	JT2211		JH23A020	JH23B020
	2.5	50	JT2222	JT2212			
	3.5	30	JT2223	JT2213			
3/4	2.5	50	JT2322	JT2312			
	3.5	30	JT2323	JT2313	JT2343		
1	8	20	JT2427	JT2417			
1-1/4	8	20		JT2515			
Three-Way, Spring Return Port B Closed, Standard Temperature (32 to 200°F, 32 to 104°F Ambient)							
1/2	4	30	JT3223	JT3213		JH13A020	JH13B020
3/4	5	25	JT3325	JT3315	JT3343		
1	8	20	JT3427	JT3417			
1-1/4	8	20		JT3517			
Two-Way, Spring Closed, High Temperature (32 to 250°F, 15 psig Steam, 32 to 169°F Ambient)							
1/2	1	75	JS2221	JS2211		JH14A020	JH14B020
	2.5	50	JS2222	JS2212			
	3.5	30	JS2223	JS2213			
3/4	2.5	50	JS2322	JS2312			
	3.5	30	JS2323	JS2313	JS2343		
1	8	20	JS2427	JS2417			
1-1/4	8	20		JS2515			
Two-Way, Spring Open, High Temperature (32 to 250°F, 15 psig Steam, 32 to 169°F Ambient)							
1/2	1	75	JS2221	JS2211		JH24A020	JH24B020
	2.5	50	JS2222	JS2212			
	3.5	30	JS2223	JS2213			
3/4	2.5	50	JS2322	JS2312			
	3.5	30	JS2323	JS2313	JS2343		
1	8	20	JS2427	JS2417			
1-1/4	8	20		JS2515			
Three-Way, Spring Return Port B Closed, High Temperature (32 to 250°F, 15 psig Steam, 32 to 169°F Ambient)							
1/2	4	30	JS3223	JS3213		JH14A020	JH14B020
3/4	5	25	JS3325	JS3315	JS3343		
1	8	20	JS3427	JS3417			
1-1/4	8	20		JS3517			

The performance specifications are nominal and conform to acceptable industry standards. For applications at conditions beyond these specifications, consult the local Johnson Controls office. Johnson Controls shall not be liable for damages resulting from misapplication or misuse of its products. © 2019 Johnson Controls. www.johnsoncontrols.com

J Series Electric Zone Valves for Assembly in the Field (Continued)

J Series Modulating Control Valves — Spring Return

Size, in.	Cv	Valve — End Connection		Actuators					
				Spring Return Open			Spring Return Closed		
		NPT	Sweat	Closeoff, psig	AC 24 V Floating Control	DC 0 to 10 V Proportional	Closeoff, psig ¹	AC 24 V Floating Control	DC 0 to 10 V Proportional
Two-Way — Spring Return									
1/2	1	JM2221	JM2211	50	JT23A000	JP23A000	50/50	JT13A000	JP13A000
	2	JM2222	JM2212	50			50/20		
	4	JM2223	JM2213	35			35/20		
3/4	2	JM2322	JM2312	50			50/20		
	4	JM2323	JM2313	35			35/20		
	7.5	JM2327	JM2317	35			35/15		
1	4		JM2413	35			35/20		
	8	JM2427	JM2417	35			35/15		
1-1/4	8		JM2517	35			35/15		
Three-Way — Spring Return									
1/2	1	JM3221	JM3211	50	JT23A000	JP23A000	50/50	JT13A000	JP13A000
	2	JM3222	JM3212	50			50/20		
	4	JM3223	JM3213	35			35/20		
3/4	2	JM3322	JM3312	50			50/20		
	4	JM3323	JM3313	35			35/20		
	7.5	JM3327	JM3317	35			35/15		
1	4		JM3413	35			35/20		
	8	JM3427	JM3417	35			35/15		
1-1/4	8		JM3517	35			35/15		

1. Operating/power failure

J Series Modulating Control Valves — Non-Spring Return

Size, in.	Cv	Valve — End Connection		Actuators (Non-Spring Return)		
		NPT	Sweat	Closeoff, psig	AC 24 V Floating Control	DC 0 to 10 V Proportional
Two-Way — Non-Spring Return						
1/2	1	JM2221	JM2211	50	JT33A00T	JP33A000
	2	JM2222	JM2212	50		
	4	JM2223	JM2213	35		
3/4	2	JM2322	JM2312	50		
	4	JM2323	JM2313	35		
	7.5	JM2327	JM2317	35		
1	4		JM2413	35		
	8	JM2427	JM2417	35		
1-1/4	8		JM2517	35		
Three-Way — Non-Spring Return						
1/2	1	JM3221	JM3211	50	JT33A00T	JP33A000
	2	JM3222	JM3212	50		
	4	JM3223	JM3213	35		
3/4	2	JM3322	JM3312	50		
	4	JM3323	JM3313	35		
	7.5	JM3327	JM3317	35		
1	4		JM3413	35		
	8	JM3427	JM3417	35		
1-1/4	8		JM3517	35		

J Series Electric Zone Valves for Assembly in the Field (Continued)

Technical Specifications

J Series Electric Zone Valves for Assembly in the Field		
Service¹		Hot Water, Chilled Water, 50/50 Glycol Solutions, and 15 psig (103 kPa) Steam for HVAC Systems
End Connections		Threaded (NPT), Sweat (All Models) Inverted Flare (JT and JS On/Off Series Only)
Fluid Temperature Limits	JT Series	32°F to 200°F (0°C to 93°C) Water in Ambient Temperatures of 32°F to 104°F (0°C to 40°C)
	JS Series	32°F to 250°F (0°C to 121°C) Water in Ambient Temperatures of 32°F to 169°F (0°C to 76°C)
	JM Series	32°F to 200°F (0°C to 93°C) Water in Ambient Temperatures of 32°F to 125°F (0°C to 52°C)
Valve Body Pressure Rating		300 psig (2,067 kPa) System Operating Pressure
Cycle Times	JT or JS Series	Bubble-Tight Shutoff
	JM Series	0.01% of Maximum Flow per ANSI/FCI 70-2, Class 4
Materials	Body	Forged Brass
	Stem	Brass (Hard Chrome Plated)
	Base Plate and Bearing Plate	Stainless Steel
	Actuator Housing (JS/JT Series)	Stainless Steel
	Actuator Housing (JM Series)	High-Temperature Plastic
	Cover (JS/JT Series)	Aluminum
	Valve Operating Paddle (JS/JT Series)	Standard-Temperature Models: Buna-N Rubber High-Temperature Models: Saturated Nitrile
	Valve Plug/Paddle (JM Series)	High-Temperature Thermoplastic/Rubber
	Stem Assembly O-Ring Seals	Viton™ Stem Assembly O-Ring Seals
Control Signal	JS and JT Series	AC 24 V, 120 V, 208 V or 230 V, Two-Wire On/Off
	JM Series	T Type, Three-Wire Floating, AC 24 V at 60 Hz P Type Proportional Control Factory Setting: 0 VDC to 10 VDC (1 VDC to 9 VDC Actual) 0 VDC to 5 VDC, 5 VDC to 10 VDC Jumper Selectable
Control Action	JM Series	P Type Proportional Control Factory Setting: Direct-Acting Valve Opens Port B as Signal Increases. Jumper Selectable
Input Impedance	JM Series	P Type Proportional Control; Voltage Input: 200,000 Ohms; Current Input: 300 Ohms
Agency Approval		All Actuators UL Listed, File E6688 or E27734 CNN XAPX (U.S.) XAPX7 (Canada), CE Mark
Power Requirements	JS/JT Series	AC 24 V, 60 Hz (6.5 W), 7 VA AC 120 V, 60 Hz (6.5 W), 7 VA AC 208 V, 60 Hz (6.5 W), 7 VA AC 230 V, 60 Hz (6.5 W), 7 VA
	JM Series	AC 24 V, 60 Hz, 1.6 VA
Electrical Connections	JS/JT Series	18 in. (457 mm) Wire Leads
	JM Series	Terminal Block
Shipping Weight	JS/JT Series	1.0 lb (454 g), Maximum Actuator and Valve Body
	JM Series	1.9 lb (860 g), Maximum Actuator and Valve Body

1. Proper water treatment is recommended; refer to the VDI 2035 Guideline.



This product is made of copper alloy, which contains lead. The product is therefore not to be used on drinking water.



This product can expose you to chemicals including lead, which is known to the State of California to cause cancer, birth defects, or other reproductive harm. For more information, go to www.P65Warnings.ca.gov.

WARNING: BRASS MAY CONTAIN LEAD

To fulfill our obligations towards Article 33, in accordance to the European REACH Regulation No 1907/2006 EC, we hereby inform you that this article contains the following Substances of Very High Concern mentioned on the Candidate list:

- Lead

VG1000 Series Flanged Ball Valves

Description

The VG1000 Series Flanged Ball Valves are primarily designed to regulate the flow of hot water, chilled water, and 50/50 glycol solutions to the demand of a controller in HVAC systems. The valves come in sizes of 2-1/2 in., 3 in., 4 in., 5 in., and 6 in. These American Society of Mechanical Engineers (ASME) Class 150 flanged valves come in both two- and three-way configurations. Johnson Controls offers valve, linkage, and actuator assemblies for factory or field mounting with either spring return or non-spring return actuators.

Refer to the *VG1000 Series Flanged Ball Valves Product Bulletin (LIT-12011228)* for important product application information and single point of contact information.

Features

- Closeoff Pressure Rating: 100 psi for Two-Way Valves; 50 psi for Three-Way Valves — provides tight shutoff.
- 300 Stainless Steel Ball and Stem Assembly — applies to systems with high-temperature water (0°F to 284°F [-18°C to 140°C]) or 25 psi saturated steam.
- 500:1 Rangeability — provides accurate control under all load conditions.

- Amodel® Flow Characterizing Disk — provides equal percentage flow characteristics for best temperature control; available in a wide array of Cv ranges to cover a broad variety of applications.
- Ethylene Propylene Diene Monomer (EPDM) Double O-Ring Stem Seal — offers tested leak-free operation for 200,000 cycles in iron-oxide contaminated water.
- Graphite-Reinforced Polytetrafluoroethylene (PTFE) Seats — include 15% graphite-reinforced ball seals that last twice as long in iron-oxide contaminated water when compared to virgin Teflon® ball seats.
- PTFE Thermal Spacer — provides thermal isolation between the actuator and the valve.
- Seats Backed with EPDM O-Rings — maintain a constant seating force that compensates for expansion, contraction, and seat wear without increasing operating torque.
- Maintenance-Free Design — performs without failure in excess of 200,000 full stroke cycles in iron-oxide contaminated water.
- Available with Factory-Mounted VA9320 or M9220 Series Electric Actuators — reduces field installation time and cost.

VG1000 Series Ball Valves Shown with Field Mounted VA9320 and M9220 Series Actuators



- Weather Shields Available for Field Installation — protect the actuator from corrosion, rain, freezing rain, sleet, and snow.

Repair Information

If the VG1000 Series Ball Valve fails to operate within its specifications, replace the valve body, actuator, or entire assembly. For replacement parts, contact the nearest Johnson Controls® representative.

Selection Charts

Flanged Stainless Steel Trim Ball Valves with Non-Spring Return Electric Actuators (Part 1 of 2)

Valve	Size, in.	Cv	Closeoff PSIG	AC and DC 24 V		
				On/Off, Floating, and Proportional	On/Off, Floating, and Proportional	
				Without Switches	With Two Auxiliary Switches	
				VA9320-HGA-2 Actuator	VA9320-HGA-2 Actuator with M9300-2 Switch Kit	
Two-Way						
VG12A5GS	2-1/2	47	100	VG12A5GS+920HGA	VG12A5GS+920HGC	
VG12A5KS				VG12A5KS+920HGA	VG12A5KS+920HGC	
VG12A5GT				VG12A5GT+920HGA	VG12A5GT+920HGC	
VG12A5KT		74		VG12A5KT+920HGA	VG12A5KT+920HGC	
VG12A5GU				VG12A5GU+920HGA	VG12A5GU+920HGC	
VG12A5KU				VG12A5KU+920HGA	VG12A5KU+920HGC	
VG12A5HT	3	74	100	VG12A5HT+920HGA	VG12A5HT+920HGC	
VG12A5LT				VG12A5LT+920HGA	VG12A5LT+920HGC	
VG12A5HU				VG12A5HU+920HGA	VG12A5HU+920HGC	
VG12A5LU		117		VG12A5LU+920HGA	VG12A5LU+920HGC	
VG12A5HV				VG12A5HV+920HGA	VG12A5HV+920HGC	
VG12A5LV				VG12A5LV+920HGA	VG12A5LV+920HGC	
VG12A5HW		176		211	VG12A5HW+920HGA	VG12A5HW+920HGC
VG12A5LW					VG12A5LW+920HGA	VG12A5LW+920HGC

VG1000 Series Flanged Ball Valves (Continued)

Flanged Stainless Steel Trim Ball Valves with Non-Spring Return Electric Actuators (Part 2 of 2)

Valve	Size, in.	Cv	Closeoff PSIG	AC and DC 24 V	
				On/Off, Floating, and Proportional	On/Off, Floating, and Proportional
				Without Switches	With Two Auxiliary Switches
				VA9320-HGA-2 Actuator	VA9320-HGA-2 Actuator with M9300-2 Switch Kit
VG12A5JU	4	117	100	VG12A5JU+920HGA	VG12A5JU+920HGC
VG12A5JV		176		VG12A5JV+920HGA	VG12A5JV+920HGC
VG12A5MW		190		VG12A5MW+920HGA	VG12A5MW+920HGC
VG12A5NY	5	290		VG12A5NY+920HGA	VG12A5NY+920HGC
VG12A5PZ	6	350		VG12A5PZ+920HGA	VG12A5PZ+920HGC
Three-Way					
VG18A5GS	2-1/2	47 / 29	50	VG18A5GS+920HGA	VG18A5GS+920HGC
VG18A5KS		74 / 47		VG18A5KS+920HGA	VG18A5KS+920HGC
VG18A5GT				VG18A5GT+920HGA	VG18A5GT+920HGC
VG18A5KT				VG18A5KT+920HGA	VG18A5KT+920HGC
VG18A5GU		117 / 74		VG18A5GU+920HGA	VG18A5GU+920HGC
VG18A5KU		VG18A5KU+920HGA		VG18A5KU+920HGC	
VG18A5HT	3	74 / 47	50	VG18A5HT+920HGA	VG18A5HT+920HGC
VG18A5LT		117 / 74		VG18A5LT+920HGA	VG18A5LT+920HGC
VG18A5HU				VG18A5HU+920HGA	VG18A5HU+920HGC
VG18A5LU				VG18A5LU+920HGA	VG18A5LU+920HGC
VG18A5HV		176 / 88		VG18A5HV+920HGA	VG18A5HV+920HGC
VG18A5LV		211 / 105		VG18A5LV+920HGA	VG18A5LV+920HGC
VG18A5HW				VG18A5HW+920HGA	VG18A5HW+920HGC
VG18A5LW				VG18A5LW+920HGA	VG18A5LW+920HGC
VG18A5JU	4	117 / 74	50	VG18A5JU+920HGA	VG18A5JU+920HGC
VG18A5JV		176 / 88		VG18A5JV+920HGA	VG18A5JV+920HGC
VG18A5MW		190 / 190		VG18A5MW+920HGA	VG18A5MW+920HGC
VG18A5NY	5	290 / 190		VG18A5NY+920HGA	VG18A5NY+920HGC
VG18A5PZ	6	350 / 180		VG18A5PZ+920HGA	VG18A5PZ+920HGC

VG1000 Series Flanged Ball Valves (Continued)

Flanged Stainless Steel Trim Ball Valves with Spring Return Electric Actuators without Switches (Part 1 of 2)

Valve	Size, in.	Cv	Closeoff PSIG	AC 24 V			AC 120 V
				Floating	DC 0 to 10 V Prop.	On/Off	On/Off
				M9220-AGA-3	M9220-GGA-3	M9220-BGA-3	M9220-BAA-3
Two-Way – Spring Return – Valve Open (Normally Open) – without Switches							
VG12A5GS	2-1/2	47	100	VG12A5GS+92NAGA	VG12A5GS+92NGGA	VG12A5GS+92NBGA	VG12A5GS+92NBAA
VG12A5KS		74		VG12A5KS+92NAGA	VG12A5KS+92NGGA	VG12A5KS+92NBGA	VG12A5KS+92NBAA
VG12A5GT				VG12A5GT+92NAGA	VG12A5GT+92NGGA	VG12A5GT+92NBGA	VG12A5GT+92NBAA
VG12A5KT		117		VG12A5KT+92NAGA	VG12A5KT+92NGGA	VG12A5KT+92NBGA	VG12A5KT+92NBAA
VG12A5GU				VG12A5GU+92NAGA	VG12A5GU+92NGGA	VG12A5GU+92NBGA	VG12A5GU+92NBAA
VG12A5KU		VG12A5KU+92NAGA		VG12A5KU+92NGGA	VG12A5KU+92NBGA	VG12A5KU+92NBAA	
VG12A5HT	3	74	100	VG12A5HT+92NAGA	VG12A5HT+92NGGA	VG12A5HT+92NBGA	VG12A5HT+92NBAA
VG12A5LT		117		VG12A5LT+92NAGA	VG12A5LT+92NGGA	VG12A5LT+92NBGA	VG12A5LT+92NBAA
VG12A5HU				VG12A5HU+92NAGA	VG12A5HU+92NGGA	VG12A5HU+92NBGA	VG12A5HU+92NBAA
VG12A5LU		176		VG12A5LU+92NAGA	VG12A5LU+92NGGA	VG12A5LU+92NBGA	VG12A5LU+92NBAA
VG12A5HV				VG12A5HV+92NAGA	VG12A5HV+92NGGA	VG12A5HV+92NBGA	VG12A5HV+92NBAA
VG12A5LV		211		VG12A5LV+92NAGA	VG12A5LV+92NGGA	VG12A5LV+92NBGA	VG12A5LV+92NBAA
VG12A5HW				VG12A5HW+92NAGA	VG12A5HW+92NGGA	VG12A5HW+92NBGA	VG12A5HW+92NBAA
VG12A5LW		VG12A5LW+92NAGA		VG12A5LW+92NGGA	VG12A5LW+92NBGA	VG12A5LW+92NBAA	
VG12A5JU	4	117	100	VG12A5JU+92NAGA	VG12A5JU+92NGGA	VG12A5JU+92NBGA	VG12A5JU+92NBAA
VG12A5JV		176		VG12A5JV+92NAGA	VG12A5JV+92NGGA	VG12A5JV+92NBGA	VG12A5JV+92NBAA
VG12A5MW		190		VG12A5MW+92NAGA	VG12A5MW+92NGGA	VG12A5MW+92NBGA	VG12A5MW+92NBAA
VG12A5NY	5	290		VG12A5NY+92NAGA	VG12A5NY+92NGGA	VG12A5NY+92NBGA	VG12A5NY+92NBAA
VG12A5PZ	6	350		VG12A5PZ+92NAGA	VG12A5PZ+92NGGA	VG12A5PZ+92NBGA	VG12A5PZ+92NBAA
Two-Way – Spring Return – Valve Closed (Normally Closed) – without Switches							
VG12A5GS	2-1/2	47	100	VG12A5GS+94NAGA	VG12A5GS+94NGGA	VG12A5GS+94NBGA	VG12A5GS+94NBAA
VG12A5KS		74		VG12A5KS+94NAGA	VG12A5KS+94NGGA	VG12A5KS+94NBGA	VG12A5KS+94NBAA
VG12A5GT				VG12A5GT+94NAGA	VG12A5GT+94NGGA	VG12A5GT+94NBGA	VG12A5GT+94NBAA
VG12A5KT		117		VG12A5KT+94NAGA	VG12A5KT+94NGGA	VG12A5KT+94NBGA	VG12A5KT+94NBAA
VG12A5GU				VG12A5GU+94NAGA	VG12A5GU+94NGGA	VG12A5GU+94NBGA	VG12A5GU+94NBAA
VG12A5KU		VG12A5KU+94NAGA		VG12A5KU+94NGGA	VG12A5KU+94NBGA	VG12A5KU+94NBAA	
VG12A5HT	3	74	100	VG12A5HT+94NAGA	VG12A5HT+94NGGA	VG12A5HT+94NBGA	VG12A5HT+94NBAA
VG12A5LT		117		VG12A5LT+94NAGA	VG12A5LT+94NGGA	VG12A5LT+94NBGA	VG12A5LT+94NBAA
VG12A5HU				VG12A5HU+94NAGA	VG12A5HU+94NGGA	VG12A5HU+94NBGA	VG12A5HU+94NBAA
VG12A5LU		176		VG12A5LU+94NAGA	VG12A5LU+94NGGA	VG12A5LU+94NBGA	VG12A5LU+94NBAA
VG12A5HV				VG12A5HV+94NAGA	VG12A5HV+94NGGA	VG12A5HV+94NBGA	VG12A5HV+94NBAA
VG12A5LV		211		VG12A5LV+94NAGA	VG12A5LV+94NGGA	VG12A5LV+94NBGA	VG12A5LV+94NBAA
VG12A5HW				VG12A5HW+94NAGA	VG12A5HW+94NGGA	VG12A5HW+94NBGA	VG12A5HW+94NBAA
VG12A5LW		VG12A5LW+94NAGA		VG12A5LW+94NGGA	VG12A5LW+94NBGA	VG12A5LW+94NBAA	
VG12A5JU	4	117	100	VG12A5JU+94NAGA	VG12A5JU+94NGGA	VG12A5JU+94NBGA	VG12A5JU+94NBAA
VG12A5JV		176		VG12A5JV+94NAGA	VG12A5JV+94NGGA	VG12A5JV+94NBGA	VG12A5JV+94NBAA
VG12A5MW		190		VG12A5MW+94NAGA	VG12A5MW+94NGGA	VG12A5MW+94NBGA	VG12A5MW+94NBAA
VG12A5NY	5	290		VG12A5NY+94NAGA	VG12A5NY+94NGGA	VG12A5NY+94NBGA	VG12A5NY+94NBAA
VG12A5PZ	6	350		VG12A5PZ+94NAGA	VG12A5PZ+94NGGA	VG12A5PZ+94NBGA	VG12A5PZ+94NBAA

The performance specifications are nominal and conform to acceptable industry standards. For applications at conditions beyond these specifications, consult the local Johnson Controls office. Johnson Controls shall not be liable for damages resulting from misapplication or misuse of its products. © 2019 Johnson Controls. www.johnsoncontrols.com

VG1000 Series Flanged Ball Valves (Continued)

Flanged Stainless Steel Trim Ball Valves with Spring Return Electric Actuators without Switches (Part 2 of 2)

Valve	Size, in.	Cv	Closeoff PSIG	AC 24 V			AC 120 V
				Floating	DC 0 to 10 V Prop.	On/Off	On/Off
				M9220-AGA-3	M9220-GGA-3	M9220-BGA-3	M9220-BAA-3
Three-Way – Spring Return Counterclockwise – Port A (Coil) Open to Port AB (Common) – without Switches							
VG18A5GS	2-1/2	47 / 29	50	VG18A5GS+92NAGA	VG18A5GS+92NGGA	VG18A5GS+92NBGA	VG18A5GS+92NBAA
VG18A5K				VG18A5KS+92NAGA	VG18A5KS+92NGGA	VG18A5KS+92NBGA	VG18A5KS+92NBAA
VG18A5GT		74 / 47		VG18A5GT+92NAGA	VG18A5GT+92NGGA	VG18A5GT+92NBGA	VG18A5GT+92NBAA
VG18A5KT				VG18A5KT+92NAGA	VG18A5KT+92NGGA	VG18A5KT+92NBGA	VG18A5KT+92NBAA
VG18A5GU		117 / 74		VG18A5GU+92NAGA	VG18A5GU+92NGGA	VG18A5GU+92NBGA	VG18A5GU+92NBAA
VG18A5KU				VG18A5KU+92NAGA	VG18A5KU+92NGGA	VG18A5KU+92NBGA	VG18A5KU+92NBAA
VG18A5HT	3	74 / 47	50	VG18A5HT+92NAGA	VG18A5HT+92NGGA	VG18A5HT+92NBGA	VG18A5HT+92NBAA
VG18A5LT				VG18A5LT+92NAGA	VG18A5LT+92NGGA	VG18A5LT+92NBGA	VG18A5LT+92NBAA
VG18A5HU		117 / 74		VG18A5HU+92NAGA	VG18A5HU+92NGGA	VG18A5HU+92NBGA	VG18A5HU+92NBAA
VG18A5LU				VG18A5LU+92NAGA	VG18A5LU+92NGGA	VG18A5LU+92NBGA	VG18A5LU+92NBAA
VG18A5HV		176 / 88		VG18A5HV+92NAGA	VG18A5HV+92NGGA	VG18A5HV+92NBGA	VG18A5HV+92NBAA
VG18A5LV				VG18A5LV+92NAGA	VG18A5LV+92NGGA	VG18A5LV+92NBGA	VG18A5LV+92NBAA
VG18A5HW		211 / 105		VG18A5HW+92NAGA	VG18A5HW+92NGGA	VG18A5HW+92NBGA	VG18A5HW+92NBAA
VG18A5LW				VG18A5LW+92NAGA	VG18A5LW+92NGGA	VG18A5LW+92NBGA	VG18A5LW+92NBAA
VG18A5JU	4	117 / 74	50	VG18A5JU+92NAGA	VG18A5JU+92NGGA	VG18A5JU+92NBGA	VG18A5JU+92NBAA
VG18A5JV		176 / 88		VG18A5JV+92NAGA	VG18A5JV+92NGGA	VG18A5JV+92NBGA	VG18A5JV+92NBAA
VG18A5MW		190 / 190		VG18A5MW+92NAGA	VG18A5MW+92NGGA	VG18A5MW+92NBGA	VG18A5MW+92NBAA
VG18A5NY	5	290 / 190		VG18A5NY+92NAGA	VG18A5NY+92NGGA	VG18A5NY+92NBGA	VG18A5NY+92NBAA
VG18A5PZ	6	350 / 180		VG18A5PZ+92NAGA	VG18A5PZ+92NGGA	VG18A5PZ+92NBGA	VG18A5PZ+92NBAA
Three-Way – Spring Return Clockwise – Port B (Bypass) Open to Port AB (Common) – without Switches							
VG18A5GS	2-1/2	47 / 29	50	VG18A5GS+94NAGA	VG18A5GS+94NGGA	VG18A5GS+94NBGA	VG18A5GS+94NBAA
VG18A5KS				VG18A5KS+94NAGA	VG18A5KS+94NGGA	VG18A5KS+94NBGA	VG18A5KS+94NBAA
VG18A5GT		74 / 47		VG18A5GT+94NAGA	VG18A5GT+94NGGA	VG18A5GT+94NBGA	VG18A5GT+94NBAA
VG18A5KT				VG18A5KT+94NAGA	VG18A5KT+94NGGA	VG18A5KT+94NBGA	VG18A5KT+94NBAA
VG18A5GU		117 / 74		VG18A5GU+94NAGA	VG18A5GU+94NGGA	VG18A5GU+94NBGA	VG18A5GU+94NBAA
VG18A5KU				VG18A5KU+94NAGA	VG18A5KU+94NGGA	VG18A5KU+94NBGA	VG18A5KU+94NBAA
VG18A5HT	3	74 / 47	50	VG18A5HT+94NAGA	VG18A5HT+94NGGA	VG18A5HT+94NBGA	VG18A5HT+94NBAA
VG18A5LT				VG18A5LT+94NAGA	VG18A5LT+94NGGA	VG18A5LT+94NBGA	VG18A5LT+94NBAA
VG18A5HU		117 / 74		VG18A5HU+94NAGA	VG18A5HU+94NGGA	VG18A5HU+94NBGA	VG18A5HU+94NBAA
VG18A5LU				VG18A5LU+94NAGA	VG18A5LU+94NGGA	VG18A5LU+94NBGA	VG18A5LU+94NBAA
VG18A5HV		176 / 88		VG18A5HV+94NAGA	VG18A5HV+94NGGA	VG18A5HV+94NBGA	VG18A5HV+94NBAA
VG18A5LV				VG18A5LV+94NAGA	VG18A5LV+94NGGA	VG18A5LV+94NBGA	VG18A5LV+94NBAA
VG18A5HW		211 / 105		VG18A5HW+94NAGA	VG18A5HW+94NGGA	VG18A5HW+94NBGA	VG18A5HW+94NBAA
VG18A5LW				VG18A5LW+94NAGA	VG18A5LW+94NGGA	VG18A5LW+94NBGA	VG18A5LW+94NBAA
VG18A5JU	4	117 / 74	50	VG18A5JU+94NAGA	VG18A5JU+94NGGA	VG18A5JU+94NBGA	VG18A5JU+94NBAA
VG18A5JV		176 / 88		VG18A5JV+94NAGA	VG18A5JV+94NGGA	VG18A5JV+94NBGA	VG18A5JV+94NBAA
VG18A5MW		190 / 190		VG18A5MW+94NAGA	VG18A5MW+94NGGA	VG18A5MW+94NBGA	VG18A5MW+94NBAA
VG18A5NY	5	290 / 190		VG18A5NY+94NAGA	VG18A5NY+94NGGA	VG18A5NY+94NBGA	VG18A5NY+94NBAA
VG18A5PZ	6	350 / 180		VG18A5PZ+94NAGA	VG18A5PZ+94NGGA	VG18A5PZ+94NBGA	VG18A5PZ+94NBAA

The performance specifications are nominal and conform to acceptable industry standards. For applications at conditions beyond these specifications, consult the local Johnson Controls office. Johnson Controls shall not be liable for damages resulting from misapplication or misuse of its products. © 2019 Johnson Controls. www.johnsoncontrols.com

VG1000 Series Flanged Ball Valves (Continued)

Flanged Stainless Steel Trim Ball Valves with Spring Return Electric Actuators with Two Switches (Part 1 of 2)

Valve	Size, in.	Cv	Closeoff PSIG	AC 24 V			AC 120 V
				Floating	DC 0 to 10 V Prop.	On/Off	On/Off
				M9220-AGC-3	M9220-GGC-3	M9220-BGC-3	M9220-BAC-3
Two-Way – Spring Return – Valve Open (Normally Open) – with Two Auxiliary Switches							
VG12A5GS	2-1/2	47	100	VG12A5GS+92NAGC	VG12A5GS+92NGGC	VG12A5GS+92NBGC	VG12A5GS+92NBAC
VG12A5KS				VG12A5KS+92NAGC	VG12A5KS+92NGGC	VG12A5KS+92NBGC	VG12A5KS+92NBAC
VG12A5GT				VG12A5GT+92NAGC	VG12A5GT+92NGGC	VG12A5GT+92NBGC	VG12A5GT+92NBAC
VG12A5KT		74		VG12A5KT+92NAGC	VG12A5KT+92NGGC	VG12A5KT+92NBGC	VG12A5KT+92NBAC
VG12A5GU				VG12A5GU+92NAGC	VG12A5GU+92NGGC	VG12A5GU+92NBGC	VG12A5GU+92NBAC
VG12A5KU				VG12A5KU+92NAGC	VG12A5KU+92NGGC	VG12A5KU+92NBGC	VG12A5KU+92NBAC
VG12A5HT	3	74	100	VG12A5HT+92NAGC	VG12A5HT+92NGGC	VG12A5HT+92NBGC	VG12A5HT+92NBAC
VG12A5LT				VG12A5LT+92NAGC	VG12A5LT+92NGGC	VG12A5LT+92NBGC	VG12A5LT+92NBAC
VG12A5HU				VG12A5HU+92NAGC	VG12A5HU+92NGGC	VG12A5HU+92NBGC	VG12A5HU+92NBAC
VG12A5LU		117		VG12A5LU+92NAGC	VG12A5LU+92NGGC	VG12A5LU+92NBGC	VG12A5LU+92NBAC
VG12A5HV				VG12A5HV+92NAGC	VG12A5HV+92NGGC	VG12A5HV+92NBGC	VG12A5HV+92NBAC
VG12A5LV				VG12A5LV+92NAGC	VG12A5LV+92NGGC	VG12A5LV+92NBGC	VG12A5LV+92NBAC
VG12A5HW		176		VG12A5HW+92NAGC	VG12A5HW+92NGGC	VG12A5HW+92NBGC	VG12A5HW+92NBAC
VG12A5LW				VG12A5LW+92NAGC	VG12A5LW+92NGGC	VG12A5LW+92NBGC	VG12A5LW+92NBAC
VG12A5JU	4	117	100	VG12A5JU+92NAGC	VG12A5JU+92NGGC	VG12A5JU+92NBGC	VG12A5JU+92NBAC
VG12A5JV				VG12A5JV+92NAGC	VG12A5JV+92NGGC	VG12A5JV+92NBGC	VG12A5JV+92NBAC
VG12A5MW				VG12A5MW+92NAGC	VG12A5MW+92NGGC	VG12A5MW+92NBGC	VG12A5MW+92NBAC
VG12A5NY		5		290	VG12A5NY+92NAGC	VG12A5NY+92NGGC	VG12A5NY+92NBGC
VG12A5PZ	6	350	VG12A5PZ+92NAGC	VG12A5PZ+92NGGC	VG12A5PZ+92NBGC	VG12A5PZ+92NBAC	
Two-Way – Spring Return – Valve Closed (Normally Closed) – with Two Auxiliary Switches							
VG12A5GS	2-1/2	47	100	VG12A5GS+94NAGC	VG12A5GS+94NGGC	VG12A5GS+94NBGC	VG12A5GS+94NBAC
VG12A5KS				VG12A5KS+94NAGC	VG12A5KS+94NGGC	VG12A5KS+94NBGC	VG12A5KS+94NBAC
VG12A5GT				VG12A5GT+94NAGC	VG12A5GT+94NGGC	VG12A5GT+94NBGC	VG12A5GT+94NBAC
VG12A5KT		74		VG12A5KT+94NAGC	VG12A5KT+94NGGC	VG12A5KT+94NBGC	VG12A5KT+94NBAC
VG12A5GU				VG12A5GU+94NAGC	VG12A5GU+94NGGC	VG12A5GU+94NBGC	VG12A5GU+94NBAC
VG12A5KU				VG12A5KU+94NAGC	VG12A5KU+94NGGC	VG12A5KU+94NBGC	VG12A5KU+94NBAC
VG12A5HT	3	74	100	VG12A5HT+94NAGC	VG12A5HT+94NGGC	VG12A5HT+94NBGC	VG12A5HT+94NBAC
VG12A5LT				VG12A5LT+94NAGC	VG12A5LT+94NGGC	VG12A5LT+94NBGC	VG12A5LT+94NBAC
VG12A5HU				VG12A5HU+94NAGC	VG12A5HU+94NGGC	VG12A5HU+94NBGC	VG12A5HU+94NBAC
VG12A5LU		117		VG12A5LU+94NAGC	VG12A5LU+94NGGC	VG12A5LU+94NBGC	VG12A5LU+94NBAC
VG12A5HV				VG12A5HV+94NAGC	VG12A5HV+94NGGC	VG12A5HV+94NBGC	VG12A5HV+94NBAC
VG12A5LV				VG12A5LV+94NAGC	VG12A5LV+94NGGC	VG12A5LV+94NBGC	VG12A5LV+94NBAC
VG12A5HW		176		VG12A5HW+94NAGC	VG12A5HW+94NGGC	VG12A5HW+94NBGC	VG12A5HW+94NBAC
VG12A5LW				VG12A5LW+94NAGC	VG12A5LW+94NGGC	VG12A5LW+94NBGC	VG12A5LW+94NBAC
VG12A5JU	4	117	100	VG12A5JU+94NAGC	VG12A5JU+94NGGC	VG12A5JU+94NBGC	VG12A5JU+94NBAC
VG12A5JV				VG12A5JV+94NAGC	VG12A5JV+94NGGC	VG12A5JV+94NBGC	VG12A5JV+94NBAC
VG12A5MW				VG12A5MW+94NAGC	VG12A5MW+94NGGC	VG12A5MW+94NBGC	VG12A5MW+94NBAC
VG12A5NY		5		290	VG12A5NY+94NAGC	VG12A5NY+94NGGC	VG12A5NY+94NBGC
VG12A5PZ	6	350	VG12A5PZ+94NAGC	VG12A5PZ+94NGGC	VG12A5PZ+94NBGC	VG12A5PZ+94NBAC	

The performance specifications are nominal and conform to acceptable industry standards. For applications at conditions beyond these specifications, consult the local Johnson Controls office. Johnson Controls shall not be liable for damages resulting from misapplication or misuse of its products. © 2019 Johnson Controls. www.johnsoncontrols.com

VG1000 Series Flanged Ball Valves (Continued)

Flanged Stainless Steel Trim Ball Valves with Spring Return Electric Actuators with Two Switches (Part 2 of 2)

Valve	Size, in.	Cv	Closeoff PSIG	AC 24 V			AC 120 V
				Floating	DC 0 to 10 V Prop.	On/Off	On/Off
				M9220-AGC-3	M9220-GGC-3	M9220-BGC-3	M9220-BAC-3
Three-Way – Spring Return Counterclockwise – Port A (Coil) Open to Port AB (Common) – with Two Auxiliary Switches							
VG18A5GS	2-1/2	47 / 29	50	VG18A5GS+92NAGC	VG18A5GS+92NGGC	VG18A5GS+92NBGC	VG18A5GS+92NBAC
VG18A5KS				VG18A5KS+92NAGC	VG18A5KS+92NGGC	VG18A5KS+92NBGC	VG18A5KS+92NBAC
VG18A5GT		74 / 47		VG18A5GT+92NAGC	VG18A5GT+92NGGC	VG18A5GT+92NBGC	VG18A5GT+92NBAC
VG18A5KT				VG18A5KT+92NAGC	VG18A5KT+92NGGC	VG18A5KT+92NBGC	VG18A5KT+92NBAC
VG18A5GU		117 / 74		VG18A5GU+92NAGC	VG18A5GU+92NGGC	VG18A5GU+92NBGC	VG18A5GU+92NBAC
VG18A5KU				VG18A5KU+92NAGC	VG18A5KU+92NGGC	VG18A5KU+92NBGC	VG18A5KU+92NBAC
VG18A5HT	3	74 / 47	50	VG18A5HT+92NAGC	VG18A5HT+92NGGC	VG18A5HT+92NBGC	VG18A5HT+92NBAC
VG18A5LT				VG18A5LT+92NAGC	VG18A5LT+92NGGC	VG18A5LT+92NBGC	VG18A5LT+92NBAC
VG18A5HU		117 / 74		VG18A5HU+92NAGC	VG18A5HU+92NGGC	VG18A5HU+92NBGC	VG18A5HU+92NBAC
VG18A5LU				VG18A5LU+92NAGC	VG18A5LU+92NGGC	VG18A5LU+92NBGC	VG18A5LU+92NBAC
VG18A5HV		176 / 88		VG18A5HV+92NAGC	VG18A5HV+92NGGC	VG18A5HV+92NBGC	VG18A5HV+92NBAC
VG18A5LV				VG18A5LV+92NAGC	VG18A5LV+92NGGC	VG18A5LV+92NBGC	VG18A5LV+92NBAC
VG18A5HW		211 / 105		VG18A5HW+92NAGC	VG18A5HW+92NGGC	VG18A5HW+92NBGC	VG18A5HW+92NBAC
VG18A5LW				VG18A5LW+92NAGC	VG18A5LW+92NGGC	VG18A5LW+92NBGC	VG18A5LW+92NBAC
VG18A5JU	4	117 / 74	50	VG18A5JU+92NAGC	VG18A5JU+92NGGC	VG18A5JU+92NBGC	VG18A5JU+92NBAC
VG18A5JV		176 / 88		VG18A5JV+92NAGC	VG18A5JV+92NGGC	VG18A5JV+92NBGC	VG18A5JV+92NBAC
VG18A5MW		190 / 190		VG18A5MW+92NAGC	VG18A5MW+92NGGC	VG18A5MW+92NBGC	VG18A5MW+92NBAC
VG18A5NY	5	290 / 190		VG18A5NY+92NAGC	VG18A5NY+92NGGC	VG18A5NY+92NBGC	VG18A5NY+92NBAC
VG18A5PZ	6	350 / 180		VG18A5PZ+92NAGC	VG18A5PZ+92NGGC	VG18A5PZ+92NBGC	VG18A5PZ+92NBAC
Three-Way – Spring Return Clockwise – Port B (Bypass) Open to Port AB (Common) – with Two Auxiliary Switches							
VG18A5GS	2-1/2	47 / 29	50	VG18A5GS+94NAGC	VG18A5GS+94NGGC	VG18A5GS+94NBGC	VG18A5GS+94NBAC
VG18A5KS				VG18A5KS+94NAGC	VG18A5KS+94NGGC	VG18A5KS+94NBGC	VG18A5KS+94NBAC
VG18A5GT		74 / 47		VG18A5GT+94NAGC	VG18A5GT+94NGGC	VG18A5GT+94NBGC	VG18A5GT+94NBAC
VG18A5KT				VG18A5KT+94NAGC	VG18A5KT+94NGGC	VG18A5KT+94NBGC	VG18A5KT+94NBAC
VG18A5GU		117 / 74		VG18A5GU+94NAGC	VG18A5GU+94NGGC	VG18A5GU+94NBGC	VG18A5GU+94NBAC
VG18A5KU				VG18A5KU+94NAGC	VG18A5KU+94NGGC	VG18A5KU+94NBGC	VG18A5KU+94NBAC
VG18A5HT	3	74 / 47	50	VG18A5HT+94NAGC	VG18A5HT+94NGGC	VG18A5HT+94NBGC	VG18A5HT+94NBAC
VG18A5LT				VG18A5LT+94NAGC	VG18A5LT+94NGGC	VG18A5LT+94NBGC	VG18A5LT+94NBAC
VG18A5HU		117 / 74		VG18A5HU+94NAGC	VG18A5HU+94NGGC	VG18A5HU+94NBGC	VG18A5HU+94NBAC
VG18A5LU				VG18A5LU+94NAGC	VG18A5LU+94NGGC	VG18A5LU+94NBGC	VG18A5LU+94NBAC
VG18A5HV		176 / 88		VG18A5HV+94NAGC	VG18A5HV+94NGGC	VG18A5HV+94NBGC	VG18A5HV+94NBAC
VG18A5LV				VG18A5LV+94NAGC	VG18A5LV+94NGGC	VG18A5LV+94NBGC	VG18A5LV+94NBAC
VG18A5HW		211 / 105		VG18A5HW+94NAGC	VG18A5HW+94NGGC	VG18A5HW+94NBGC	VG18A5HW+94NBAC
VG18A5LW				VG18A5LW+94NAGC	VG18A5LW+94NGGC	VG18A5LW+94NBGC	VG18A5LW+94NBAC
VG18A5JU	4	117 / 74	50	VG18A5JU+94NAGC	VG18A5JU+94NGGC	VG18A5JU+94NBGC	VG18A5JU+94NBAC
VG18A5JV		176 / 88		VG18A5JV+94NAGC	VG18A5JV+94NGGC	VG18A5JV+94NBGC	VG18A5JV+94NBAC
VG18A5MW		190 / 190		VG18A5MW+94NAGC	VG18A5MW+94NGGC	VG18A5MW+94NBGC	VG18A5MW+94NBAC
VG18A5NY	5	290 / 190		VG18A5NY+94NAGC	VG18A5NY+94NGGC	VG18A5NY+94NBGC	VG18A5NY+94NBAC
VG18A5PZ	6	350 / 180		VG18A5PZ+94NAGC	VG18A5PZ+94NGGC	VG18A5PZ+94NBGC	VG18A5PZ+94NBAC

The performance specifications are nominal and conform to acceptable industry standards. For applications at conditions beyond these specifications, consult the local Johnson Controls office. Johnson Controls shall not be liable for damages resulting from misapplication or misuse of its products. © 2019 Johnson Controls. www.johnsoncontrols.com

VG1000 Series Flanged Ball Valves (Continued)

Technical Specifications

VG1000 Series Flanged Ball Valves		
Service ¹	Hot water, chilled water, 50/50 Glycol solutions, and 25 psig (172 kPa) saturated steam for HVAC systems	
Valve Fluid Temperature Limits	0°F to 284°F (-18°C to 140°C)	
Valve Body Pressure/Temperature Rating	Water	ASME Class 150 250 psi at -20°F to 100°F (29°C to 38°C) 235 psi at 200°F(93°C) 218 psi at 284°F(140°C)
	Steam	25 psig (172 kPa) saturated steam for HVAC systems
Maximum Closeoff Pressure	Two-Way	100 psi (689 kPa)
	Three-Way	50 psi (345 kPa)
Maximum Recommended Operating Pressure Drop	30 psi (207 kPa) for quiet service	
Flow Characteristics	Two-Way	Equal Percentage
	Three-Way	Equal Percentage Flow Characteristics of In-Line Port or Linear Percentage Flow Characteristics of Angle Port
Rangeability ²	Greater than 500:1	
Minimum Ambient Operating Temperature	-4°F (-20°C)	VA9320 Series Non-Spring Return Actuators
	-40°F (-40°C)	M9220 Series Spring Return Actuators
Maximum Ambient Operating Temperature ³	122°F (50°C)	VA9320 Series Non-Spring Return Actuators
	131°F (55°C)	M9220 Series Spring Return Actuators
Leakage	Two- or Three-Way	0.01% of Maximum Flow, Control Port, ANSI/FCI 70-2, Class 4
	Three-Way	1% of Maximum Flow, Bypass Port
End Connections	ASME Class 150 Flange	
Materials	Body	Brass
	Flanges	Ductile Iron
	Ball	300 Series Stainless Steel
	Stem	300 Series Stainless Steel
	Seats	Graphite Reinforced PTFE with EPDM O-Ring Backing
	Stem Seals	EPDM O-Rings
	Flow Control Disk	Amodel AS-1145HS Polyphthalamide Resin
Compliance 	Europe	CE Mark - Johnson Controls declares that this product is in compliance with the essential requirements and other relevant provisions of the Pressure Equipment Directive (PED).

1. Refer to the VDI 2035 Guideline for proper water treatment.
2. Rangeability is defined as the ratio of maximum controllable flow to minimum controllable flow.
3. In steam applications, install the valve with the stem horizontal to the piping and wrap the valve and piping with insulation.



WARNING

This product is made of copper alloy, which contains lead. The product is therefore not to be used on drinking water.



WARNING

This product can expose you to chemicals including lead, which is known to the State of California to cause cancer, birth defects, or other reproductive harm. For more information, go to www.P65Warnings.ca.gov.

WARNING: BRASS MAY CONTAIN LEAD

To fulfill our obligations towards Article 33, in accordance to the European REACH Regulation No 1907/2006 EC, we hereby inform you that this article contains the following Substances of Very High Concern mentioned on the Candidate list:

- Lead

VG1000 Series Flanged Ball Valves for Assembly in the Field

Description

The VG1000 Series Flanged Ball Valves are primarily designed to regulate the flow of hot water, chilled water, and 50/50 glycol solutions to the demand of a controller in HVAC systems. The valves come in sizes of 2-1/2 in., 3 in., 4 in., 5 in., and 6 in. These American Society of Mechanical Engineers (ASME) Class 150 flanged valves come in both two- and three-way configurations. Johnson Controls offers valve, linkage, and actuator assemblies for factory or field mounting with either spring return or non-spring return actuators.

Refer to the *VG1000 Series Flanged Ball Valve Product Bulletin (LIT-12011228)* for important product application information and single point of contact information.

Features

- Closeoff Pressure Rating: 100 psi for two-way valves; 50 psi for three-way valves—provides tight shutoff.
- 300 Stainless Steel Ball and Stem Assembly—applies to systems with high-temperature water (0°F to 284°F [-18°C to 140°C]) or 25 psi saturated steam.
- 500:1 Rangeability—provides accurate control under all load conditions.

- Amodel® Flow Characterizing Disk—provides equal percentage flow characteristics for best temperature control; available in a wide array of Cv ranges to cover a broad variety of applications.
- Ethylene Propylene Diene Monomer (EPDM) Double O-Ring Stem Seal—offers tested leak-free operation for 200,000 cycles in iron-oxide contaminated water.
- Graphite-Reinforced Polytetrafluoroethylene (PTFE) Seats—include 15% graphite-reinforced ball seals that last twice as long in iron-oxide contaminated water when compared to virgin Teflon® ball seats.
- PTFE Thermal Spacer—provides thermal isolation between the actuator and the valve.
- Seats Backed with EPDM O-Rings—maintain a constant seating force that compensates for expansion, contraction, and seat wear without increasing operating torque.
- Maintenance-Free Design—performs without failure in excess of 200,000 full stroke cycles in iron-oxide contaminated water.
- Available with Factory-Mounted VA9320 or M9220 Series Electric Actuators—reduces field installation time and cost.

VG1000 Series Ball Valves Shown with Field Mounted M9000 Series Actuators



- M9000-340 and M9000-343 Weather Shields Available for Field Installation—protect the actuator from corrosion, rain, freezing rain, sleet, and snow.

Repair Information

If the VG1000 Series Ball Valve fails to operate within its specifications, replace the valve body, actuator, or entire assembly. For replacement parts, contact the nearest Johnson Controls® representative.

WARNING

This product is made of copper alloy, which contains lead. The product is therefore not to be used on drinking water.

Selection Charts

Flanged Ball Valves (for Assembly in the Field)

Part Number		Size, in. (DN)	Closeoff psig		Control Disk	Control Port A	Control Port B						
Two-Way	Three-Way		Two-Way	Three-Way		Cv (Kv)	Cv (Kv)						
VG12A5GS	VG18A5GS	2-1/2 (DN65)	100	50	Yes	47 (40)	29 (25)						
VG12A5KS	VG18A5KS					74 (63)	47 (40)						
VG12A5GT	VG18A5GT					117 (100)	74 (63)						
VG12A5KT	VG18A5KT												
VG12A5GU	VG18A5GU												
VG12A5KU	VG18A5KU												
VG12A5HT	VG18A5HT	3 (DN80)	100	50	Yes	74 (63)	47 (40)						
VG12A5LT	VG18A5LT					117 (100)	74 (63)						
VG12A5HU	VG18A5HU					176 (150)	88 (75)						
VG12A5LU	VG18A5LU												
VG12A5HV	VG18A5HV												
VG12A5LV	VG18A5LV												
VG12A5HW	VG18A5HW				No	211 (180)	105 (90)						
VG12A5LW	VG18A5LW												
VG12A5JU	VG18A5JU							4 (DN100)	100	50	Yes	117 (100)	74 (63)
VG12A5JV	VG18A5JV										No	176 (150)	88 (75)
VG12A5MW	VG18A5MW	4 (DN100)	100	50	Yes	190 (164)	190 (164)						
VG12A5NY	VG18A5NY	5 (DN125)	100	50	Yes	290 (251)	190 (164)						
VG12A5PZ	VG18A5PZ	6 (DN150)	100	50	No	350 (302)	180 (156)						

WARNING: BRASS MAY CONTAIN LEAD

To fulfill our obligations towards Article 33, in accordance to the European REACH Regulation No 1907/2006 EC, we hereby inform you that this article contains the following Substances of Very High Concern mentioned on the Candidate list:

- Lead

VG1000 Series Flanged Ball Valves for Assembly in the Field (Continued)

Actuators and Linkages (for Assembly in the Field)

Spring Return	Control Type				Supply Voltage	SPDT Aux. Switches	Actuator Code	Switch Kit Code	Linkage Code	Optional Weather Shield	
	on/off	floating	proportional 0(2)...10 V	proportional 0(4)...20 mA ¹							
Yes		X			24 VAC/VDC	0	M9220-AGA-3	-	M9000-519	M9000-340	
		X				2	M9220-AGC-3				
	X				120 VAC	0	M9220-BAA-3				
	X					2	M9220-BAC-3				
	X				24 VAC/VDC	0	M9220-BGA-3				
	X					2	M9220-BGC-3				
				X	24 VAC/VDC	0	M9220-GGA-3				
				X		2	M9220-GGC-3				
No	X	X	X	X	100...240 VDC	0	M9320-AUA-2	-	-	M9000-343	
	X	X	X	X		2	M9320-AUA-2				M9300-2
	X	X	X	X	24 VAC/VDC	0	M9320-HGA-2				-
	X	X	X	X		2	M9320-HGA-2				M9300-2

¹ with field furnished 500 ohm resistor

Technical Specifications

VG1000 Series Flanged Ball Valves for Assembly in the Field		
Service ¹	Hot water, chilled water, 50/50 Glycol solutions, and 25 psig (172 kPa) saturated steam for HVAC systems	
Valve Fluid Temperature Limits	0°F to 284°F (-18°C to 140°C)	
Valve Body Pressure/Temperature Rating	Water	ASME Class 150 250 psi at -20°F to 100°F (29°C to 38°C) 235 psi at 200°F (93°C) 218 psi at 284°F (140°C)
	Steam	25 psig (172 kPa) saturated steam for HVAC systems
Maximum Closeoff Pressure	Two-Way	100 psi (689 kPa)
	Three-Way	50 psi (345 kPa)
Maximum Recommended Operating Pressure Drop	30 psi (207 kPa)	
Flow Characteristics	Two-Way	Equal percentage
	Three-Way	Equal percentage flow characteristics of in-line port or Linear percentage flow characteristics of angle port
Rangeability ²	Greater than 500:1	
Minimum Ambient Operating Temperature	-4°F (-20°C)	M9320 Series Non-Spring Return Actuators
	-40°F (-40°C)	M9220 Series Spring Return Actuators
Maximum Ambient Operating Temperature ³	122°F (50°C)	M9320 Series Non-Spring Return Actuators
	131°F (55°C)	M9220 Series Spring Return Actuators
Leakage	Two- or Three-Way	0.01% of maximum flow, control port, ANSI/FCI 70-2, Class 4
	Three-Way	1% of maximum Flow, bypass port
End Connections	ASME Class 150 flange	
Materials	Body	Brass
	Flanges	Ductile iron
	Ball	300 Series stainless steel
	Stem	300 Series stainless steel
	Seats	Graphite reinforced PTFE with EPDM O-Ring backing
	Stem Seals	EPDM O-Rings
	Flow Control Disk	Amodel AS-1145HS Polyphthalamide resin
Compliance	Europe	CE Mark - Johnson Controls declares that this product is in compliance with the essential requirements and other relevant provisions of the Pressure Equipment Directive (PED).

1. Refer to the VDI 2035 Guideline for proper water treatment.
2. Rangeability is defined as the ratio of maximum controllable flow to minimum controllable flow.
3. In steam applications, install the valve with the stem horizontal to the piping and wrap the valve and piping with insulation.

	WARNING	This product can expose you to chemicals including lead, which is known to the State of California to cause cancer, birth defects, or other reproductive harm. For more information, go to www.P65Warnings.ca.gov .
--	----------------	---

VG2000 Series Electric Cast Iron Flanged Globe Valves

Description

VG2000 Series Electric Cast Iron Flanged Globe Valves are designed primarily to regulate the flow of water and steam in response to the demand of a controller in HVAC systems. Available in sizes 2-1/2 in. through 6 in., these ANSI Class 125 valves are available in Normally Open (N.O.), Normally Closed (N.C.), and three-way mixing configurations. Both electric and pneumatic actuators are available for factory or field mounting.

Refer to the *VG2000 Series Cast Iron Flanged Globe Valves Product Bulletin (LIT-977133)* for important product application information.

Repair Information

If the VG2000 Series Globe Valve fails to operate within its specifications, replace the valve body, actuator, or entire assembly. For replacement parts, contact the nearest Johnson Controls® representative.

Features

- Complete Family of 2-1/2 in. through 6 in. Cast Iron Flanged Globe Valves, Brass Trim, with Several Styles of Electric and Pneumatic Actuators — offers a broad selection from which to choose.
- Flexible Features and Options Ordering Matrix — allow engineering to suit your specific application from thousands of easy-to-select, factory-assembled combinations.
- Standard Johnson Controls Ring Pack Packings — provide industry-leading reliability and operating life.
- Every Valve Tested for Leakage — provides energy conservation and ensures occupant comfort.



VG2000 Series Electric Cast Iron Flanged Globe Valves

Selection Charts

VG2000 Series Valves with M91xx-xGx-2 Actuators — Non-Spring Return

Valve Code Number	Size, in.	Cv	Closeoff psig	On/Off Floating without Switches	Proportional without Switches	On/Off Floating with Two Switches	Proportional with Two Switches
				M9116-AGA-2 M9124-AGA-2	M9116-GGA-2 M9124-GGA-2	M9116-AGC-2 M9124-AGC-2	M9116-GGC-2 M9124-GGC-2
Two-Way, Push-Down-to-Close							
VG2231TM	2-1/2	51	62	VG2231TM+916AGA	VG2231TM+916GGA	VG2231TM+916AGC	VG2231TM+916GGC
	2-1/2	51	101	VG2231TM+924AGA	VG2231TM+924GGA	VG2231TM+924AGC	VG2231TM+924GGC
VG2231UM	3	83	27	VG2231UM+916AGA	VG2231UM+916GGA	VG2231UM+916AGC	VG2231UM+916GGC
	3	83	43	VG2231UM+924AGA	VG2231UM+924GGA	VG2231UM+924AGC	VG2231UM+924GGC
	3	83	88	VG2231UM2924AGA ¹	VG2231UM2924GGA ¹	VG2231UM2924AGC ¹	VG2231UM2924GGC ¹
VG2231VM	4	150	24	VG2231VM+924AGA	VG2231VM+924GGA	VG2231VM+924AGC	VG2231VM+924GGC
	4	150	49	VG2231VM2924AGA ¹	VG2231VM2924GGA ¹	VG2231VM2924AGC ¹	VG2231VM2924GGC ¹
VG2231WN	5	240	26	VG2231WN2924AGA ¹	VG2231WN2924GGA ¹	VG2231WN2924AGC ¹	VG2231WN2924GGC ¹
VG2231YN	6	350	16	VG2231YN2924AGA ¹	VG2231YN2924GGA ¹	VG2231YN2924AGC ¹	VG2231YN2924GGC ¹
Three-Way, Mixing							
VG2831TM	2-1/2	54	37	VG2831TM+916AGA	VG2831TM+916GGA	VG2831TM+916AGC	VG2831TM+916GGC
	2-1/2	54	60	VG2831TM+924AGA	VG2831TM+924GGA	VG2831TM+924AGC	VG2831TM+924GGC
VG2831UM	3	80	16	VG2831UM+916AGA	VG2831UM+916GGA	VG2831UM+916AGC	VG2831UM+916GGC
	3	80	26	VG2831UM+924AGA	VG2831UM+924GGA	VG2831UM+924AGC	VG2831UM+924GGC
	3	80	53	VG2831UM2924AGA ¹	VG2831UM2924GGA ¹	VG2831UM2924AGC ¹	VG2831UM2924GGC ¹
VG2831VM	4	157	9	VG2831VM+916AGA	VG2831VM+916GGA	VG2831VM+916AGC	VG2831VM+916GGC
	4	157	14	VG2831VM+924AGA	VG2831VM+924GGA	VG2831VM+924AGC	VG2831VM+924GGC
	4	157	30	VG2831VM2924AGA ¹	VG2831VM2924GGA ¹	VG2831VM2924AGC ¹	VG2831VM2924GGC ¹
VG2831WN	5	238	7	VG2831WN+924AGA	VG2831WN+924GGA	VG2831WN+924AGC	VG2831WN+924GGC
	5	238	15	VG2831WN2924AGA ¹	VG2831WN2924GGA ¹	VG2831WN2924AGC ¹	VG2831WN2924GGC ¹
VG2831YN	6	347	4	VG2831YN+924AGA	VG2831YN+924GGA	VG2831YN+924AGC	VG2831YN+924GGC
	6	347	9	VG2831YN2924AGA ¹	VG2831YN2924GGA ¹	VG2831YN2924AGC ¹	VG2831YN2924GGC ¹

1. Valve assemblies have two actuators mounted in tandem. On tandem actuator assemblies with switches, only one actuator is provided with auxiliary switches. M9116-AGx-2 actuators are not designed for tandem operation.

VG2000 Series Electric Cast Iron Flanged Globe Valves (Continued)



VG2000 Series Valves with M9220 Series Non-Spring-Return Electric Valve Actuators

VG2000 Series Valves with M9220-xGx-3 Actuators — Spring Return — Floating and On/Off

Valve Code Number	Size, in.	Cv	Closeoff psig	Floating		On/Off	
				Without Switches	With Two Switches	Without Switches	With Two Switches
				M9220-AGA-3	M9220-AGC-3	M9220-BGA-3	M9220-BGC-3
Two-Way — Spring Return Normally Open — Valve Stem Up							
VG2231TM	2-1/2	51	76	VG2231TM+92NAGA	VG2231TM+92NAGC	VG2231TM+92NBGA	VG2231TM+92NBGC
VG2231UM	3	83	33	VG2231UM+92NAGA	VG2231UM+92NAGC	VG2231UM+92NBGA	VG2231UM+92NBGC
	3	83	66	VG2231UM292NAGA ¹	VG2231UM292NAGC ¹	VG2231UM292NBGA ¹	VG2231UM292NBGC ¹
VG2231VM	4	150	37	VG2231VM292NAGA ¹	VG2231VM292NAGC ¹	VG2231VM292NBGA ¹	VG2231VM292NBGC ¹
VG2231WM	5	240	20	VG2231WM292NAGA ¹	VG2231WM292NAGC ¹	VG2231WM292NBGA ¹	VG2231WM292NBGC ¹
Two-Way — Spring Return Normally Closed — Valve Stem Down							
VG2231TM	2-1/2	51	76	VG2231TM+94NAGA	VG2231TM+94NAGC	VG2231TM+94NBGA	VG2231TM+94NBGC
VG2231UM	3	83	33	VG2231UM+94NAGA	VG2231UM+94NAGC	VG2231UM+94NBGA	VG2231UM+94NBGC
	3	83	66	VG2231UM294NAGA ¹	VG2231UM294NAGC ¹	VG2231UM294NBGA ¹	VG2231UM294NBGC ¹
VG2231VM	4	150	37	VG2231VM294NAGA ¹	VG2231VM294NAGC ¹	VG2231VM294NBGA ¹	VG2231VM294NBGC ¹
VG2231WM	5	240	20	VG2231WM294NAGA ¹	VG2231WM294NAGC ¹	VG2231WM294NBGA ¹	VG2231WM294NBGC ¹
Three-Way Mixing — Spring Return — Valve Stem Up — Side Inlet Port Closed							
VG2831TM	2-1/2	54	45	VG2831TM+92NAGA	VG2831TM+92NAGC	VG2831TM+92NBGA	VG2831TM+92NBGC
VG2831UM	3	80	20	VG2831UM+92NAGA	VG2831UM+92NAGC	VG2831UM+92NBGA	VG2831UM+92NBGC
	3	80	40	VG2831UM292NAGA ¹	VG2831UM292NAGC ¹	VG2831UM292NBGA ¹	VG2831UM292NBGC ¹
VG2831VM	4	157	11	VG2831VM+92NAGA	VG2831VM+92NAGC	VG2831VM+92NBGA	VG2831VM+92NBGC
	4	157	22	VG2831VM292NAGA ¹	VG2831VM292NAGC ¹	VG2831VM292NBGA ¹	VG2831VM292NBGC ¹
VG2831WN	5	238	12	VG2831WN292NAGA ¹	VG2831WN292NAGC ¹	VG2831WN292NBGA ¹	VG2831WN292NBGC ¹
VG2831YN	6	347	7	VG2831YN292NAGA ¹	VG2831YN292NAGC ¹	VG2831YN292NBGA ¹	VG2831YN292NBGC ¹
Three-Way Mixing — Spring Return — Valve Stem Down — Side Inlet Port Open							
VG2831TM	2-1/2	54	45	VG2831TM+94NAGA	VG2831TM+94NAGC	VG2831TM+94NBGA	VG2831TM+94NBGC
VG2831UM	3	80	20	VG2831UM+94NAGA	VG2831UM+94NAGC	VG2831UM+94NBGA	VG2831UM+94NBGC
	3	80	40	VG2831UM294NAGA ¹	VG2831UM294NAGC ¹	VG2831UM294NBGA ¹	VG2831UM294NBGC ¹
VG2831VM	4	157	11	VG2831VM+94NAGA	VG2831VM+94NAGC	VG2831VM+94NBGA	VG2831VM+94NBGC
	4	157	22	VG2831VM294NAGA ¹	VG2831VM294NAGC ¹	VG2831VM294NBGA ¹	VG2831VM294NBGC ¹
VG2831WN	5	238	12	VG2831WN294NAGA ¹	VG2831WN294NAGC ¹	VG2831WN294NBGA ¹	VG2831WN294NBGC ¹
VG2831YN	6	347	7	VG2831YN294NAGA ¹	VG2831YN294NAGC ¹	VG2831YN294NBGA ¹	VG2831YN294NBGC ¹

1. Valve assemblies have two actuators mounted in tandem. On tandem actuator assemblies with switches, only one actuator is provided with auxiliary switches.

VG2000 Series Electric Cast Iron Flanged Globe Valves (Continued)

VG2000 Series Valves with M9220-xGx-3 Actuators — Proportional

Valve Code Number	Size, in.	Cv	Closeoff psig	Without Switches	With Two Switches
				M9220-GGA-3	M9220-GGC-3
Two-Way — Spring Return Normally Open — Valve Stem Up					
VG2231TM	2-1/2	51	76	VG2231TM+92NGGA	VG2231TM+92NGGC
VG2231UM	3	83	33	VG2231UM+92NGGA	VG2231UM+92NGGC
	3	83	66	VG2231UM292NGGA ¹	VG2231UM292NGGC ¹
VG2231VM	4	150	37	VG2231VM292NGGA ¹	VG2231VM292NGGC ¹
VG2231WM	5	240	20	VG2231WM292NGGA ¹	VG2231WM292NGGC ¹
Two-Way — Spring Return Normally Closed — Valve Stem Down					
VG2231TM	2-1/2	51	76	VG2231TM+94NGGA	VG2231TM+94NGGC
VG2231UM	3	83	33	VG2231UM+94NGGA	VG2231UM+94NGGC
	3	83	66	VG2231UM294NGGA ¹	VG2231UM294NGGC ¹
VG2231VM	4	150	37	VG2231VM294NGGA ¹	VG2231VM294NGGC ¹
VG2231WM	5	240	20	VG2231WM294NGGA ¹	VG2231WM294NGGC ¹
Three-Way Mixing — Spring Return — Valve Stem Up — Side Inlet Port Closed					
VG2831TM	2-1/2	54	45	VG2831TM+92NGGA	VG2831TM+92NGGC
VG2831UM	3	80	20	VG2831UM+92NGGA	VG2831UM+92NGGC
	3	80	40	VG2831UM292NGGA ¹	VG2831UM292NGGC ¹
VG2831VM	4	157	11	VG2831VM+92NGGA	VG2831VM+92NGGC
	4	157	22	VG2831VM292NGGA ¹	VG2831VM292NGGC ¹
VG2831WN	5	238	12	VG2831WN292NGGA ¹	VG2831WN292NGGC ¹
VG2831YN	6	347	7	VG2831YN292NGGA ¹	VG2831YN292NGGC ¹
Three-Way Mixing — Spring Return — Valve Stem Down — Side Inlet Port Open					
VG2831TM	2-1/2	54	45	VG2831TM+94NGGA	VG2831TM+94NGGC
VG2831UM	3	80	20	VG2831UM+94NGGA	VG2831UM+94NGGC
	3	80	40	VG2831UM294NGGA ¹	VG2831UM294NGGC ¹
VG2831VM	4	157	11	VG2831VM+94NGGA	VG2831VM+94NGGC
	4	157	22	VG2831VM294NGGA ¹	VG2831VM294NGGC ¹
VG2831WN	5	238	12	VG2831WN294NGGA ¹	VG2831WN294NGGC ¹
VG2831YN	6	347	7	VG2831YN294NGGA ¹	VG2831YN294NGGC ¹

1. Valve assemblies have two actuators mounted in tandem. On tandem actuator assemblies with switches, only one actuator is provided with auxiliary switches.

VG2000 Series Electric Cast Iron Flanged Globe Valves (Continued)

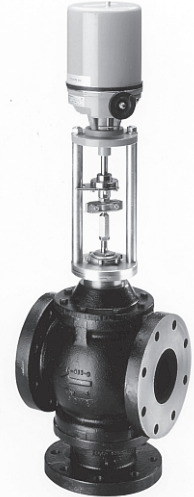

VG2000 Series Valves with VA-3100 Series Non-Spring-Return Electric Valve Actuators

VG2000 Series Valves with VA-6100 Series Non-Spring-Return Electric Valve Actuators

VG2000 Series Valves with VA-3100-xGx Series Non-Spring-Return Actuators

Valve Code Number	Size, in.	Cv	Closeoff psig	Floating without Switches	Floating with Feedback and Two Switches	0 to 10 VDC Proportional with Two Switches
				VA-3100-AGA	VA-3100-AGC	VA-3100-HGC
Two-Way, Push-Down-to-Close						
VG2231TM	2-1/2	51	115	VG2231TM+300AGA	VG2231TM+300AGC	VG2231TM+300HGC
VG2231UM	3	83	79	VG2231UM+301AGA	VG2231UM+301AGC	VG2231UM+301HGC
VG2231VM	4	150	45	VG2231VM+301AGA	VG2231VM+301AGC	VG2231VM+301HGC
VG2231WN	5	240	29	VG2231WN+302AGA	VG2231WN+302AGC	VG2231WN+302HGC
VG2231YN	6	350	20	VG2231YN+302AGA	VG2231YN+302AGC	VG2231YN+302HGC
Three-Way Mixing						
VG2831TM	2-1/2	54	69	VG2831TM+300AGA	VG2831TM+300AGC	VG2831TM+300HGC
VG2831UM	3	80	48	VG2831UM+301AGA	VG2831UM+301AGC	VG2831UM+301HGC
VG2831VM	4	157	27	VG2831VM+301AGA	VG2831VM+301AGC	VG2831VM+301HGC
VG2831WN	5	238	17	VG2831WN+302AGA	VG2831WN+302AGC	VG2831WN+302HGC
VG2831YN	6	347	12	VG2831YN+302AGA	VG2831YN+302AGC	VG2831YN+302HGC

VG2000 Series Valves with VA-6100-xGx Series Non-Spring-Return Actuators

Valve Code Number	Size, in.	Cv	Closeoff psig	Floating with Two Switches	0 to 10 VDC Proportional with Two Switches
				VA-6100-AGC	VA-6100-HGC
Two-Way Push-Down-to-Close					
VG2231VM	4	150	89	VG2231VM+602AGC	VG2231VM+602HGC
VG2231WN	5	240	57	VG2231WN+602AGC	VG2231WN+602HGC
VG2231YN	6	350	40	VG2231YN+602AGC	VG2231YN+602HGC
Three-Way Mixing					
VG2831VM	4	157	54	VG2831VM+602AGC	VG2831VM+602HGC
VG2831WN	5	238	34	VG2831WN+602AGC	VG2831WN+602HGC
VG2831YN	6	347	24	VG2831YN+602AGC	VG2831YN+602HGC

The performance specifications are nominal and conform to acceptable industry standards. For applications at conditions beyond these specifications, consult the local Johnson Controls office. Johnson Controls shall not be liable for damages resulting from misapplication or misuse of its products. © 2019 Johnson Controls. www.johnsoncontrols.com

VG2000 Series Electric Cast Iron Flanged Globe Valves (Continued)

Technical Specifications

VG2000 Series Electric Cast Iron Flanged Globe Valves		
Service¹		Hot Water, Chilled Water, 50% Glycol Solutions, and Steam for HVAC Systems
Valve Stroke	2-1/2 and 3 in. Valves	3/4 in. (19 mm)
	3 and 4 in. Valves	1-1/8 in. (29 mm)
	5 in. Valves	1-3/8 in. (35 mm)
	6 in. Valves	1-1/2 in. (38 mm)
Valve Body Rating		Meets Requirements of ASME B16.1, Class 125
Valve Assembly Maximum Allowable Pressure/Temperature	Steam	35 psig (241 kPa) at 281°F (138°C)
	Water	175 psig (1,206 kPa) up to 150°F (66°C), Decreasing to 125 psig (861 kPa) at 281°F (138°C)
Leakage		0.1% of Maximum Flow
Inherent Flow Characteristics		Modified Linear
Rangeability²	2-1/2 in. Valves	6.5:1
	3 in. Valves	7.7:1
	4 in. Valves	9.3:1
	5 in. Valves	10.7:1
	6 in. Valves	10.4:1
Spring Ranges (MP8000 Series Actuators)		3 psig to 7 psig, 4 psig to 8 psig, and 9 psig to 13 psig (21 kPa to 48 kPa, 28 kPa to 55 kPa, and 62 kPa to 90 kPa)
Maximum Recommended Operating Pressure Drop		35 psig (241 kPa) for All Valve Sizes
Maximum Actuator Supply Pressure (Pneumatically Actuated Valves Only)		25 psig (172 kPa) Maximum
Materials	Body	Cast Iron with Black Lacquer Finish
	Stem	316 Stainless Steel
	Plug	Brass
	Packing	Ethylene Propylene Terpolymer (EPT) Ring Packs
Valve Fluid Operating Temperature Limits		35°F to 281°F (2°C to 138°C), 35 psig (241 kPa) Saturated Steam
Actuator Ambient Operating Temperature Limits		Refer to the Appropriate Actuator Product Bulletin.
Compliance	Canada	CRN: 0C1100.9087YTN

1. Proper water treatment is recommended; refer to the VDI 2035 Guideline.

2. Rangeability is defined as the ratio of maximum flow to minimum controllable flow.

VG2000 Series Pneumatic Cast Iron Flanged Globe Valves

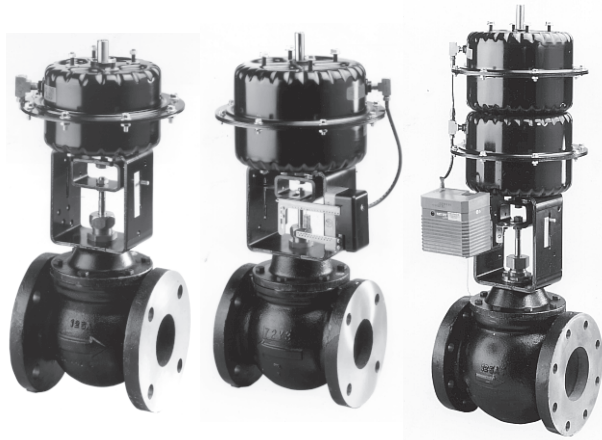

MP8000 Series Actuators
Mounted on VG2231 Two-Way Normally Open Valves



MP8000 Series Actuators
Mounted on VG2431 Two-Way Normally Closed Valves

Description

VG2000 Series Valve

VG2000 Series Cast Iron Flanged Globe Valves are designed primarily to regulate the flow of water and steam in response to the demand of a controller.

Refer to the *VG2000 Series Cast Iron Flanged Globe Valve Product Bulletin (LIT-977133)* for important product application information.

MP8000 Series Actuators

MP8000 Series Pneumatic Actuators are designed to accurately position hot-water, chilled-water, and steam-control valves in response to a pneumatic signal from a controller.

Refer to the *MP8000 Series Pneumatic Valve Actuators Product Bulletin (LIT-977257)* for important product application information.

Features

VG2000 Series Valve

- controls hot or chilled water, 35 psig saturated steam
- ANSI cast iron 125 flange meets ANSI B16.1
- ANSI III closeoff, leakage: 0.1% of maximum flow
- 175 psig static pressure rating at water temperatures 35°F to 150°F; decreasing to 125 psig at 281°F
- maximum recommended operating pressure drop: 35 psig
- maximum actuator supply pressure: 25 psig

MP8000 Series Actuators

- three sizes: 25 sq. in., 50 sq. in., and 100 sq. in. effective diaphragm area
- spring action field reversible
- optional pneumatic or electro-pneumatic positioner

Repair Information

If the VG2000 Series Globe Valve fails to operate within its specifications, replace the valve body, actuator, or entire assembly. For replacement parts, contact the nearest Johnson Controls® representative.

For complete details about VG2000 Series Cast Iron Flanged Valve repair parts, refer to the *VG2000 Series Cast Iron Flanged Valve Product Bulletin (LIT-977133)*. For complete details about MP8000 Series Pneumatic Actuator repair parts, refer to the *MP8000 Series Pneumatic Actuator Product Bulletin (LIT-977257)*.



MP8000 Series Actuators
Mounted on VG2831 Three-Way Mixing Valves

VG2000 Series Pneumatic Cast Iron Flanged Globe Valves (Continued)

Selection Charts

Two-Way Normally Open Pneumatic Cast Iron Flanged Globe Valves

Spring Range			3 psig to 7 psig		4 psig to 8 psig		9 psig to 13 psig	
Valve Code Number	Size, in.	Cv	Closeoff psig	Code Number	Closeoff psig	Code Number	Closeoff psig	Code Number
With MP82 Series Actuators — 25 sq. in. Effective Diaphragm Area								
VG2231TL	2-1/2	51	53	VG2231TL+823C00	49	VG2231TL+823D00	28	VG2231TL+823E00
VG2231UL	3	83	37	VG2231UL+823C00	34	VG2231UL+823D00	19	VG2231UL+823E00
With MP84 Series Actuators — 50 sq. in. Effective Diaphragm Area								
VG2231TM	2-1/2	51	109	VG2231TM+843C00	100	VG2231TM+843D00	58	VG2231TM+843E00
VG2231UM	3	83	75	VG2231UM+845C00	70	VG2231UM+845D00	40	VG2231UM+845E00
VG2231VM	4	150	42	VG2231VM+845C00	39	VG2231VM+845D00	23	VG2231VM+845E00
With MP86 Series Actuators — 100 sq. in. Effective Diaphragm Area								
VG2231UN	3	83	152	VG2231UN+865C00	140	VG2231UN+865D00	81	VG2231UN+865E00
VG2231VN	4	150	86	VG2231VN+865C00	79	VG2231VN+865D00	46	VG2231VN+865E00
VG2231WN	5	240	55	VG2231WN+867C00	51	VG2231WN+867D00	29	VG2231WN+867E00
VG2231YN	6	350	38	VG2231YN+867C00	35	VG2231YN+867D00	20	VG2231YN+867E00

Two-Way Normally Closed Pneumatic Cast Iron Flanged Globe Valves

Spring Range			3 psig to 7 psig		4 psig to 8 psig		9 psig to 13 psig	
Valve Code Number	Size, in.	Cv	Closeoff psig	Code Number	Closeoff psig	Code Number	Closeoff psig	Code Number
With MP84 Series Actuators — 50 sq. in. Effective Diaphragm Area								
VG2431TM	2-1/2	54	24	VG2431TM+843C00	32	VG2431TM+843D00	75	VG2431TM+843E00
VG2431UM	3	83	17	VG2431UM+845C00	22	VG2431UM+845D00	52	VG2431UM+845E00
VG2431VM	4	150	9	VG2431VM+845C00	13	VG2431VM+845D00	29	VG2431VM+845E00
With MP86 Series Actuators — 100 sq. in. Effective Diaphragm Area								
VG2431UN	3	83	34	VG2431UN+865C00	46	VG2431UN+865D00	105	VG2431UN+865E00
VG2431VN	4	150	19	VG2431VN+865C00	26	VG2431VN+865D00	59	VG2431VN+865E00
VG2431WN	5	237	12	VG2431WN+867C00	17	VG2431WN+867D00	38	VG2431WN+867E00
VG2431YN	6	344	9	VG2431YN+867C00	11	VG2431YN+867D00	26	VG2431YN+867E00

Three-Way Mixing Pneumatic Cast Iron Flanged Globe Valves

Spring Range			3 psig to 7 psig		4 psig to 8 psig		9 psig to 13 psig	
Valve Code Number	Size, in.	Cv	Closeoff psig	Code Number	Closeoff psig	Code Number	Closeoff psig	Code Number
With MP84 Series Actuators — 50 sq. in. Effective Diaphragm Area								
VG2831TM	2-1/2	54	65/14	VG2831TM+843C00	60/19	VG2831TM+843D00	35/45	VG2831TM+843E00
VG2831UM	3	80	45/10	VG2831UM+845C00	42/13	VG2831UM+845D00	24/31	VG2831UM+845E00
VG2831VM	4	157	25/6	VG2831VM+845C00	23/8	VG2831VM+845D00	14/18	VG2831VM+845E00
With MP86 Series Actuators — 100 sq. in. Effective Diaphragm Area								
VG2831UN	3	80	91/21	VG2831UN+865C00	84/28	VG2831UN+865D00	49/63	VG2831UN+865E00
VG2831VN	4	157	51/12	VG2831VN+865C00	47/16	VG2831VN+865D00	27/35	VG2831VN+865E00
VG2831WN	5	238	33/7	VG2831WN+867C00	30/10	VG2831WN+867D00	18/23	VG2831WN+867E00
VG2831YN	6	347	23/5	VG2831YN+867C00	21/7	VG2831YN+867D00	12/16	VG2831YN+867E00

Optional Positioner — Change the 00 at the end of the code number to either 01 or 02

Optional Positioner	Mounting Bracket	Type	Control Input	Output Capacity	Ordering Code
V-9502-95	MP8000-6002	Pneumatic	2 to 12 psig Start 3 to 13 psig Span	1,000 scim — Dual Barbed Fitting 1,600 scim — 1/4 in. Barbed Fitting	01
EPP-1000-8	MP8000-6003	Electro-Pneumatic	0 to 10 VDC 4 to 20 mA 135 Ohm Slidewire	476 scim	02

VG2000 Series Pneumatic Cast Iron Flanged Globe Valves (Continued)

Technical Specifications

VG2000 Series Pneumatic Cast Iron Flanged Globe Valves		
Service¹		Hot Water, Chilled Water, 50/50 Glycol Solutions, and Steam for HVAC Systems
Fluid Temperature Limits	Water	35°F to 281°F (2°C to 138°C)
	Steam	35 psig (241 kPa) Saturated Steam
Maximum Allowable Pressure/Temperature	Water	175 psig (1,206 kPa) up to 150°F (66°C) Decreasing to 125 psig (861 kPa) at 281°F (138°C)
	Steam	35 psig (241 kPa) Saturated Steam at 281°F (138°C)
Valve Body Pressure/Temperature Rating		Meets Requirements of ANSI B16.15, Class 125
Maximum Recommended Operating Pressure Drop		35 psig (241 kPa)
Flow Characteristics		Modified Linear
Rangeability²	2-1/2 in. Valves	6.5:1
	3 in. Valves	7.7:1
	4 in. Valves	9.3:1
	5 in. Valves	10.7:1
	6 in. Valves	10.4:1
Leakage		0.1% of Maximum Flow per ANSI/FCI 70-2, Class 3
Actuator Ambient Operating Temperature Limits		-20°F to 150°F (-29°C to 66°C)
Maximum Actuator Supply Pressure		25 psig (172 kPa) Maximum
Materials	Body	Cast Iron with Black Lacquer Finish
	Stem	Stainless Steel
	Plug	Brass
	Packing	Ethylene Propylene Terpolymer (EPT) Rink Packs
Compliance	Canada	CRN: 0C1100.9087YTN

1. Refer to the VDI 2035 Guideline for recommended proper water treatment.
2. Rangeability is defined as the ratio of maximum controllable flow to minimum controllable flow.



WARNING This product is made of copper alloy, which contains lead. The product is therefore not to be used on drinking water.



WARNING This product can expose you to chemicals including lead, which is known to the State of California to cause cancer, birth defects, or other reproductive harm. For more information, go to www.P65Warnings.ca.gov.

WARNING: BRASS MAY CONTAIN LEAD

To fulfill our obligations towards Article 33, in accordance to the European REACH Regulation No 1907/2006 EC, we hereby inform you that this article contains the following Substances of Very High Concern mentioned on the Candidate list:

- Lead

VG2000 Series Cast Iron Flanged Globe Valves for Assembly in the Field

Description

VG2000 Series Cast Iron Flanged Globe Valves are designed primarily to regulate the flow of water and steam in response to the demand of a controller in HVAC systems. Available in sizes 2-1/2 in. through 6 in., these ANSI Class 125 valves are available in Normally Open (N.O.), Normally Closed (N.C.), and three-way mixing configurations. Both electric and pneumatic actuators are available for factory or field mounting.

Refer to the *VG2000 Series Cast Iron Flanged Globe Valves Product Bulletin (LIT-977133)* for important product application information.

Repair Information

If the VG2000 Series Globe Valve fails to operate within its specifications, replace the valve body, actuator, or entire assembly. For replacement parts, contact the nearest Johnson Controls® representative.

Features

- Complete Family of 2-1/2 in. through 6 in. Cast Iron Flanged Globe Valves, Brass Trim, with Several Styles of Electric and Pneumatic Actuators — offers a broad selection from which to choose.
- Flexible Features and Options Ordering Matrix — allow engineering to suit your specific application from thousands of easy-to-select, factory-assembled combinations.
- Standard Johnson Controls Ring Pack Packings — provide industry-leading reliability and operating life.
- Every Valve Tested for Leakage — provides energy conservation and ensures occupant comfort.



MP84 Actuated VG2000 Series Valve

Selection Charts

VG2000 Series Flanged Globe Valve Bodies/MP8000 Series Pneumatic Spring-Return Actuators

Spring Range			3 psig to 7 psig		4 psig to 8 psig		9 psig to 13 psig	
Valve Body Code Number	Valve Size, in.	Cv	Closeoff psig	Actuator Code Number	Closeoff psig	Actuator Code Number	Closeoff psig	Actuator Code Number
Two-Way Normally Open with MP82 Series								
VG2231TL	2-1/2	51	53	MP823C001E	49	MP823D001E	28	MP823E001E
VG2231UL	3	83	37	MP823C001E	34	MP823D001E	19	MP823E001E
Two-Way Normally Open with MP84 Series								
VG2231TM	2-1/2	51	109	MP843C001F	100	MP843D001F	58	MP843E001F
VG2231UM	3	83	75	MP845C001F	70	MP845D001F	40	MP845E001F
VG2231VM	4	150	42	MP845C001F	39	MP845D001F	23	MP845E001F
Two-Way Normally Open with MP86 Series								
VG2231UN	3	83	152	MP865C001G	140	MP865D001G	81	MP865E001G
VG2231VN	4	150	86	MP865C001G	79	MP865D001G	46	MP865E001G
VG2231WN	5	240	55	MP867C001G	51	MP867D001G	29	MP867E001G
VG2231YN	6	350	38	MP867C001G	35	MP867D001G	20	MP867E001G
Two-Way Normally Closed with MP84 Series								
VG2431TM	2-1/2	54	24	MP843C001F	32	MP843D001F	75	MP843E001F
VG2431UM	3	83	17	MP845C001F	22	MP845D001F	52	MP845E001F
VG2431VM	4	150	9	MP845C001F	13	MP845D001F	29	MP845E001F
Two-Way Normally Closed with MP86 Series								
VG2431UN	3	83	34	MP865C001G	46	MP865D001G	105	MP865E001G
VG2431VN	4	150	19	MP865C001G	26	MP865D001G	59	MP865E001G
VG2431WN	5	237	12	MP867C001G	17	MP867D001G	38	MP867E001G
VG2431YN	6	344	9	MP867C001G	11	MP867D001G	26	MP867E001G
Three-Way Mixing with MP84 Series								
VG2831TM	2-1/2	54	65/14	MP843C001F	60/19	MP843D001F	35/45	MP843E001F
VG2831UM	3	80	45/10	MP845C001F	42/13	MP845D001F	24/31	MP845E001F
VG2831VM	4	157	25/6	MP845C001F	23/8	MP845D001F	14/18	MP845E001F
Three-Way Mixing with MP86 Series								
VG2831UN	3	80	91/21	MP865C001G	84/28	MP865D001G	49/63	MP865E001G
VG2831VN	4	157	51/12	MP865C001G	47/16	MP865D001G	27/35	MP865E001G
VG2831WN	5	238	33/7	MP867C001G	23/8	MP867D001G	18/23	MP867E001G
VG2831YN	6	347	23/5	MP867C001G	21/7	MP867D001G	12/16	MP867E001G

VG2000 Series Cast Iron Flanged Globe Valves for Assembly in the Field (Continued)

Mounting Kits for Field Mounting MP8000 Series Pneumatic Actuators

Mounting Kit Code Number	Actuator Style	Valve Size, in.	Stem Type (Diameter)
MP8000-6201	MP82/MP83/MP84/MP85	2-1/2 through 4	L Stem (3/8 in.) or M Stem (3/8 in.)
MP8000-6203	MP86/MP87	3 through 6	N Stem (1/2 in.)

Positioners and Positioner Mounting Kits for MP8000 Series Pneumatic Valve Actuators

Code Number	Description	Shipping Weight, lb (kg)
V-9502-95	Pneumatic Valve Actuator Positioner (Less Spring and Mounting Hardware)	0.9 (0.41)
MP8000-6002	Mounting Kit for V-9502-95 Pneumatic Valve Actuator Positioner (Kit Includes All Necessary Mounting Hardware and Six Springs)	1.3 (0.59)
EPP-1000-8	Electro-Pneumatic Valve Actuator Positioner (Less Mounting Hardware)	1.6 (0.73)
MP8000-6003	Mounting Kit for EPP-1000-8 Electro-Pneumatic Valve Actuator Positioner (Kit Includes All Necessary Mounting Hardware)	1.5 (0.68)



M9100 Non-Spring-Return Actuated VG2000 Series Valves



M9220 Spring-Return Actuated VG2000 Series Valves

VG2000 Flanged Globe Valve Bodies/M9100 Series Electric Non-Spring-Return Actuators

Valve Body Code Number	Valve Size, in.	Cv	Closeoff psig	Mounting Kit Code Number	Non-Spring-Return Actuator Code Numbers			
					Floating Control		0 VDC to 10 VDC Proportional	
					Without Switches	With Two Switches	Without Switches	With Two Switches
Two-Way Push-Down-to-Close								
VG2231TM	2-1/2	51	62	M9000-530	M9116-AGA-2	M9116-AGC-2	M9116-GGA-2	M9116-GGC-2
	2-1/2	51	101		M9124-AGA-2	M9124-AGC-2	M9124-GGA-2	M9124-GGC-2
VG2231UM	3	83	27	M9000-531	M9116-AGA-2	M9116-AGC-2	M9116-GGA-2	M9116-GGC-2
	3	83	43		M9124-AGA-2	M9124-AGC-2	M9124-GGA-2	M9124-GGC-2
	3	83	88	M9000-532	M9124-AGA-2 ¹	M9124-AGC-2 ¹	M9124-GGA-2 ¹	M9124-GGC-2 ¹
VG2231VM	4	150	24	M9000-531	M9124-AGA-2	M9124-AGC-2	M9124-GGA-2	M9124-GGC-2
	4	150	49		M9000-532	M9124-AGA-2 ¹	M9124-AGC-2 ¹	M9124-GGA-2 ¹
VG2231WN	5	240	26	M9000-534	M9124-AGA-2 ¹	M9124-AGC-2 ¹	M9124-GGA-2 ¹	M9124-GGC-2 ¹
VG2231YN	6	350	16	M9000-536	M9124-AGA-2 ¹	M9124-AGC-2 ¹	M9124-GGA-2 ¹	M9124-GGC-2 ¹
Three-Way Mixing								
VG2831TM	2-1/2	54	37	M9000-530	M9116-AGA-2	M9116-AGC-2	M9116-GGA-2	M9116-GGC-2
	2-1/2	54	60		M9124-AGA-2	M9124-AGC-2	M9124-GGA-2	M9124-GGC-2
VG2831UM	3	80	16	M9000-531	M9116-AGA-2	M9116-AGC-2	M9116-GGA-2	M9116-GGC-2
	3	80	26		M9124-AGA-2	M9124-AGC-2	M9124-GGA-2	M9124-GGC-2
	3	80	53	M9000-532	M9124-AGA-2 ¹	M9124-AGC-2 ¹	M9124-GGA-2 ¹	M9124-GGC-2 ¹
VG2831VM	4	157	9	M9000-531	M9116-AGA-2	M9116-AGC-2	M9116-GGA-2	M9116-GGC-2
	4	157	14		M9124-AGA-2	M9124-AGC-2	M9124-GGA-2	M9124-GGC-2
VG2831VM	4	157	30	M9000-532	M9124-AGA-2 ¹	M9124-AGC-2 ¹	M9124-GGA-2 ¹	M9124-GGC-2 ¹
VG2831WN	5	238	7	M9000-533	M9124-AGA-2	M9124-AGC-2	M9124-GGA-2	M9124-GGC-2
	5	238	15		M9000-534	M9124-AGA-2 ¹	M9124-AGC-2 ¹	M9124-GGA-2 ¹
VG2831YN	6	347	4	M9000-535	M9124-AGA-2	M9124-AGC-2	M9124-GGA-2	M9124-GGC-2
	6	347	9		M9000-536	M9124-AGA-2 ¹	M9124-AGC-2 ¹	M9124-GGA-2 ¹

1. Valve assemblies require two actuators mounted in tandem. On tandem assemblies with switches, only one actuator is required to have switches.

VG2000 Series Cast Iron Flanged Globe Valves for Assembly in the Field (Continued)

Flanged Globe Valve Bodies/M9220 Series Electric Spring-Return Actuators

Valve Body Code Number	Valve Size, in.	Cv	Closeoff psig	Mounting Kit Code Number	Spring-Return Actuator Code Numbers					
					Floating Control		On/Off Control		0 VDC to 10 VDC Proportional	
					Without Switches	With Two Switches	Without Switches	With Two Switches	Without Switches	With Two Switches
Two-Way Push-Down-to-Close¹										
VG2231TM	2-1/2	51	76	M9000-530	M9220-AGA-3	M9220-AGC-3	M9220-BGA-3	M9220-BGC-3	M9220-GGA-3	M9220-GGC-3
VG2231UM	3	83	33	M9000-531	M9220-AGA-3 ²	M9220-AGC-3 ²	M9220-BGA-3 ²	M9220-BGC-3 ²	M9220-GGA-3 ²	M9220-GGC-3 ²
	3	83	66	M9000-532						
VG2231VM	4	150	37							
VG2231WN	5	240	20	M9000-534						
Three-Way Mixing										
VG2831TM	2-1/2	54	45	M9000-530	M9220-AGA-3	M9220-AGC-3	M9220-BGA-3	M9220-BGC-3	M9220-GGA-3	M9220-GGC-3
VG2831UM	3	80	20	M9000-531	M9220-AGA-3 ²	M9220-AGC-3 ²	M9220-BGA-3 ²	M9220-BGC-3 ²	M9220-GGA-3 ²	M9220-GGC-3 ²
	3	80	40	M9000-532						
VG2831VM	4	157	11	M9000-531	M9220-AGA-3	M9220-AGC-3	M9220-BGA-3	M9220-BGC-3	M9220-GGA-3	
VG2831VN	4	157	22	M9000-532	M9220-AGA-3 ²	M9220-AGC-3 ²	M9220-BGA-3 ²	M9220-BGC-3 ²	M9220-GGA-3 ²	M9220-GGC-3 ²
VG2831WN	5	238	12	M9000-534						
VG2831YN	6	347	7	M9000-536						

1. Actuator can be configured to spring-return the valve either open or closed.
2. Valve assemblies require two actuators mounted in tandem. On tandem assemblies with switches, only one actuator is required to have switches.

Mounting Kits for Field Mounting M9100 and M9220 Series Electric Actuators

Mounting Kit Code Number	Number of Actuators	Valve	Valve Size, in.	Valve Stroke, in.	Stem Type (Diameter)
M9000-530	Single	VG2x31TM	2-1/2	3/4	M Stem (3/8 in.)
M9000-531		VG2x31UM and VG2x31VM	3 and 4	1-1/8	
M9000-532	Dual				
M9000-533	Single	VG2x31WN	5	1-3/8	N Stem (1/2 in.)
M9000-534		Dual			
M9000-535	Single	VG2x31YN	6	1-1/2	
M9000-536	Dual				
M9000-537		VG2x31UN and VG2x31VN	3 and 4	1-1/8	

VG2000 Series Cast Iron Flanged Globe Valves for Assembly in the Field (Continued)



VA-3100 Actuated Two-Way VG2000 Series Valves



VA-6100 Actuated Three-Way VG2000 Series Valves

Flanged Globe Valve Bodies/VA-3100 Series Electric Non-Spring-Return Actuators

Valve Body Code Number	Valve Size, in.	Cv	Closeoff psig	Mounting Kit Code Number	Non-Spring-Return Actuator Code Numbers		
					Floating without Switches	Floating with Two Switches	0 VDC to 10 VDC Proportional with Two Switches
Two-Way Push-Down-to-Close							
VG2231TM	2-1/2	51	115	VA-3100-500	VA-3100-AGA	VA-3100-AGC	VA-3100-HGC
VG2231UM	3	83	79				
VG2231VM	4	150	45				
VG2231WM	5	240	29	VA-3100-501			
VG2231YN	6	350	20				
Three-Way Mixing							
VG2831TM	2-1/2	54	69	VA-3100-500	VA-3100-AGA	VA-3100-AGC	VA-3100-HGC
VG2831UM	3	80	48				
VG2831VM	4	157	27				
VG2831WM	5	238	17	VA-3100-501			
VG2831YN	6	347	12				

Flanged Globe Valve Bodies/VA-6100 Series Electric Non-Spring-Return Actuators

Valve Body Code Number	Valve Size, in.	Cv	Closeoff psig	Mounting Kit Code Number	Non-Spring-Return Actuator Code Numbers	
					Floating without Switches	0 VDC to 10 VDC Proportional with Two Switches
Two-Way Push-Down-to-Close						
VG2231VN	4	150	89	VA-3100-501	VA-6100-AGC	VA-6100-HGC
VG2231WM	5	240	57			
VG2231YN	6	350	40			
Three-Way Mixing						
VG2831VM	4	157	54	VA-3100-501	VA-6100-AGC	VA-6100-HGC
VG2831WM	5	238	34			
VG2831YN	6	347	24			

Mounting Kits for Field Mounting VA-3100 and VA-6100 Series Electric Actuators

Mounting Kit Code Number	Actuator Series	Valve Size, in.	Stem Type (Diameter)
VA-3100-500	VA-3100	2-1/2 through 4	M Stem (3/8 in.)
		5 and 6	N Stem (1/2 in.)
VA-3100-501	VA-6100	4 through 6	

Tool Kit for VA-3100 Series Electric Actuators

Code Number	Description
VA-3100-101	Auxiliary Switch Cam Adjusting Wrench (Used on VA-3100 Series Electric Actuators – One Wrench is Supplied with Each Actuator)

VG2000 Series Cast Iron Flanged Globe Valves for Assembly in the Field (Continued)

Technical Specifications

VG2000 Series Cast Iron Flanged Globe Valves for Assembly in the Field		
Service¹		Hot Water, Chilled Water, 50% Glycol Solutions, and Steam for HVAC Systems
Valve Stroke	2-1/2 and 3 in. Valves	3/4 in. (19 mm)
	3 and 4 in. Valves	1-1/8 in. (29 mm)
	5 in. Valves	1-3/8 in. (35 mm)
	6 in. Valves	1-1/2 in. (38 mm)
Valve Body Rating		Meets Requirements of ASME B16.1, Class 125
Valve Assembly Maximum Allowable Pressure/Temperature	Steam	35 psig (241 kPa) at 281°F (138°C)
	Water	175 psig (1,206 kPa) up to 150°F (66°C), Decreasing to 125 psig (861 kPa) at 281°F (138°C)
Leakage		0.1% of Maximum Flow
Inherent Flow Characteristics		Modified Linear
Rangeability²	2-1/2 in. Valves	6.5:1
	3 in. Valves	7.7:1
	4 in. Valves	9.3:1
	5 in. Valves	10.7:1
	6 in. Valves	10.4:1
Spring Ranges (MP8000 Series Actuators)		3 psig to 7 psig, 4 psig to 8 psig, and 9 psig to 13 psig (21 kPa to 48 kPa, 28 kPa to 55 kPa, and 62 kPa to 90 kPa)
Maximum Recommended Operating Pressure Drop		35 psig (241 kPa) for All Valve Sizes
Maximum Actuator Supply Pressure (Pneumatically Actuated Valves Only)		25 psig (172 kPa) Maximum
Materials	Body	Cast Iron with Black Lacquer Finish
	Stem	316 Stainless Steel
	Plug	Brass
	Packing	Ethylene Propylene Terpolymer (EPT) Ring Packs
Valve Fluid Operating Temperature Limits		35°F to 281°F (2°C to 138°C), 35 psig (241 kPa) Saturated Steam
Actuator Ambient Operating Temperature Limits	M91xx Series	-4°F to 122°F (-20°C to 50°C)
	M9220 Series	-40°F to 131°F (-40°C to 55°C)
	VA-3100 Series	14°F to 140°F (-10°C to 60°C) Floating Control 14°F to 122°F (-10°C to 50°C) Proportional Control
	VA-6100 Series	-4°F to 140°F (-20°C to 60°C)
	MP8000 Series	-20°F to 150°F (-29°C to 66°C)
Compliance	Canada	CRN: 0C1100.9087YTN

1. Proper water treatment is recommended; refer to the VDI 2035 Guideline.
 2. Rangeability is defined as the ratio of maximum flow to minimum controllable flow.

VA-3100 Series Electric Valve Actuators

Description

VA-3100 Series Electric Valve Actuators use a synchronous motor to accurately position Johnson Controls® VG2000 Series Cast Iron Flanged Globe Valves in HVAC and industrial applications. These non-spring-return electric actuators have a 675 lb (3,000 N) force output for on/off (floating) or proportional control. Integral auxiliary switches are available to indicate end-stop position or to perform switching functions. Position feedback is also available through an isolated 2,000 ohm potentiometer. All models feature a manual hand crank for manual positioning of the valve, independent of a power supply.

Refer to the *VA-3100 Series Electric Valve Actuators Product Bulletin (LIT-977283)* for important product application information.

Features

- synchronous motor with pressure switches
- provides a constant running speed and establishes fixed closeoff forces
- two-bolt coupler clamp provides quick and easy coupling of the actuator to the valve stem
- on/off (floating) or proportional control allows optimal choice of control signal
- adjustable starting point, span, and action (proportional control model only) provides application flexibility and allows for easy sequencing from only one output signal
- 0 to 10 VDC position feedback signal (proportional control model only) provides accurate valve position indication in response to an input signal up to 10 VDC
- auxiliary switches and feedback potentiometer available on select models provide independent verification of actuator position
- manual hand crank allows for manual positioning of the valve, independent of a power supply

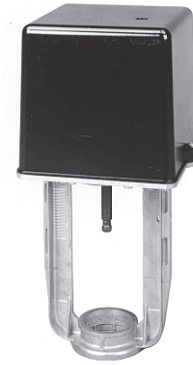

VA-3100 Series Electric Valve Actuator

Repair Information

If the VA-3100 Series Electric Valve Actuator fails to operate within its specifications, replace the unit. For a replacement actuator, contact the nearest Johnson Controls representative.

Selection Chart

Description	Actuator Model		
	VA-3100-AGA	VA-3100-AGC	VA-3100-HGC
On/Off (Floating) Control	■	■	—
Proportional Control	—	—	■
Feedback:			
2,000 Ohm Potentiometer	—	■	—
Two Auxiliary Switches	—	■	■
Stem and Valve Size:			
M Stem (3/8 in.), 2-1/2 in. through 4 in. Valves	■	■	■
N Stem (1/2 in.), 5 in. and 6 in. Valves	■	■	■

Accessories

Code Number	Description	Ship.Wt., lb ¹
VA-3100-101	Auxiliary Switch Cam Adjusting Wrench (Used on VA-3100 Series Electric Actuators – One Wrench is Supplied with Each Actuator)	0.1
VA-3100-500	Mounting Kit for Field Mounting VA-3100 Series Electric Actuators to 2-1/2 through 4 in. VG2000 Series Cast Iron Flanged Globe Valves with 3/8 in. M Stem (Kit Includes One Stem Jam Nut, One Yoke Adaptor, One Packing Nut, One 2-1/4 in. Length Stem Adaptor for 2-1/2 in. Valves, and One 2-1/2 in. Length Stem Adaptor for 3 in. and 4 in. Valves)	3.0
VA-3100-501	Mounting Kit for Field Mounting VA-3100 Series Electric Actuators to 5 in. and 6 in. VG2000 Series Cast Iron Flanged Globe Valves with 1/2 in. N Stem (Kit Includes One Stem Jam Nut, One Yoke Adaptor, One Packing Nut, and One Stem Adaptor)	3.5

1. lb x 0.454 = kg.

Technical Specifications

VA-3100 Series Electric Valve Actuators		
Force Output		675 lb (3,000 N)
Power Requirements	On/Off (Floating) Control Models	20 VAC to 28 VAC, 60 Hz; 16 VA Minimum
	Proportional Control Models	20 VAC to 28 VAC, 60 Hz; 18 VA Minimum
Input Signal	On/Off (Floating) Control Models	20 VAC to 28 VAC, 60 Hz
	Proportional Control Models	0 VDC to 10 VDC
Input Impedance	Proportional Control Models Only	5,600 Ohms
Feedback Signal	VA-3100-AGC Only	0 to 2,000 Ohms
	VA-3100-HGC Only	Approximately 9 VDC Span (0.5 VDC with Valve Stem Fully Down; 9.5 VDC with Valve Stem Fully Up)
Switch Contact Rating		5 A, 24 VAC
Maximum Stroke		1-21/32 in. (42 mm)
Nominal Timing for 1 in. Stroke		92 Seconds
Ambient Operating Temperature Limits (Limited by the Actuator)	On/Off (Floating) Control Models	14°F to 140°F (-10°C to 60°C)
	Proportional Control Models	14°F to 122°F (-10°C to 50°C)
Agency Compliance		UL 873 Listed, File E27734; CSA C22.2 No. 139 Certified
Enclosure Rating		NEMA 3/3R, IP 54
Shipping Weight		9.7 lb (4.4 kg)

VA-6100 Series Electric Valve Actuators

Description

VA-6100 Series Electric Valve Actuators use a synchronous motor to accurately position Johnson Controls® VG2000 Series Cast Iron Flanged Globe Valves in HVAC and industrial applications. These non-spring-return electric actuators have a 1,350 lb (6,000 N) force output for on/off (floating) or proportional control. Integral auxiliary switches are available to indicate end-stop position or to perform switching functions. Position feedback is also available through an isolated 2,000 ohm potentiometer at a fixed stroke of 1-21/32 in. (42.07 mm). All models feature a manual hand wheel for manual positioning of the valve, independent of a power supply.

Refer to the *VA-6100 Series Electric Valve Actuators Product Bulletin (LIT-977284)* for important product application information.

Features

- synchronous motor with pressure switches provides a constant running speed and establishes fixed closeoff forces
- two-bolt coupler clamp provides quick and easy coupling of the actuator to the valve stem

- on/off (floating) or proportional control allows optimal choice of control signal
- adjustable starting point, span, and action (proportional control model only) provides application flexibility and allows for easy sequencing from only one output signal
- 0 VDC to 10 VDC or 0 mA to 20 mA position feedback signal (proportional control model only) provides accurate valve position indication in response to an input signal up to 10 VDC or 20 mA
- auxiliary switches and feedback potentiometer available on select models provides independent verification of actuator position
- manual hand wheel allows for manual positioning of the valve, independent of a power supply

Repair Information

If the VA-6100 Series Electric Actuator fails to operate within its specifications, replace the unit. For a replacement actuator, contact the nearest Johnson Controls representative.



VA-6100 Series Electric Valve Actuator

Selection Chart

Description	Actuator Model	
	VA-6100-AGC	VA-6100-HGC
On/Off (Floating) Control	■	—
Proportional Control	—	■
Feedback:		
2,000 Ohm Potentiometer	■	—
Two Auxiliary Switches	■	■
0 VDC to 10 VDC or 0 mA to 20 mA Output	—	■
Stem and Valve Size:		
N Stem (1/2 in.), 4 in. through 6 in. Valves	■	■

Accessories

Code Number	Description	Ship. Wt., lb ¹
VA-3100-501	Mounting Kit for Field Mounting VA-6100 Series Electric Actuators to 5 in. and 6 in. VG2000 Series Cast Iron Flanged Globe Valves with 1/2 in. N Stem (Kit Includes One Stem Jam Nut, One Yoke Adaptor, One Packing Nut, and One Stem Adaptor)	3.5

1. 1 lb x 0.454 = kg.

Technical Specifications

VA-6100 Series Electric Valve Actuators	
Force Output	1,350 lb (6,000 N)
Power Requirements	VA-6100-AGC Only 20 VAC to 28 VAC, 60 Hz; 37 VA Minimum
	VA-6100-HGC Only 20 VAC to 28 VAC, 60 Hz; 42 VA Minimum
Input Signal	VA-6100-AGC Only 20 VAC to 28 VAC, 60 Hz
	VA-6100-HGC Only 0 VDC to 10 VDC or 0 mA to 20 mA; Minimum Control Signal Adjustable 0 VDC to 8 VDC or 0 mA to 16 mA; Maximum Control Signal Adjustable 2 VDC to 10 VDC or 4 mA to 20 mA ¹
Input Impedance	VA-6100-HGC Only 10,000 Ohms with 0 VDC to 10 VDC Input; 500 Ohms with 0 mA to 20 mA Input
Feedback Signal	VA-6100-AGC Only 0 to 2,000 Ohms
	VA-6100-HGC Only 0.35 VDC to 9.65 VDC or 0.7 mA to 19.3 mA
Switch Contact Rating	5 A, 24 VAC
Maximum Stroke	1-21/32 in. (42 mm)
Nominal Timing for 1-1/2 in. Stroke	111 Seconds
Ambient Operating Temperature Limits (Limited by the Actuator)	-4°F to 140°F (-20°C to 60°C)
Agency Compliance	UL 873 Listed, File E27734, CCN XAPX; cUL C22.2 No. 24-93 Listed, File E27734, CCN XAPX7
Enclosure Rating	NEMA 4, IP 65
Shipping Weight	16.5 lb (7.5 kg)

1. The maximum control signal must always exceed the minimum control signal by at least 2 VDC or 4 mA.

M9000-53x Series Cast Iron Flanged Valve Linkage Kits

Description

The M9000-53x Series Cast Iron Flanged Valve Linkage Kits are designed specifically for field mounting M9116 and M9124 Series Non-Spring-Return (NSR) and M9220 Series Spring-Return (SR) Electric Actuators to VG2000 Series Cast Iron Flanged Valves of sizes 2-1/2 in. through 6 in. Kits are available to fit older Johnson Controls® valves for easy conversion from pneumatic or older electric actuator installations.

Refer to the *M9000-53x Series Cast Iron Flanged Valve Linkage Kit for M9000 Series Electric Actuators Product Bulletin (LIT-1201538)* for important product application information.

Features

- Dedicated Models — facilitate quick and easy installation regardless of the valve stroke and electric actuator chosen.
- Single Anti-Rotation Bracket — allows one linkage to accommodate spring-return and non-spring-return electric actuators.
- Two-Bolt Coupler Clamp — provides quick and easy coupling of the linkage to the valve stem.
- Easy to Convert from Single to Tandem Actuators — accommodates changing shutoff requirements.

Repair Information

If the M9000-53x Series Linkage Kit fails to operate within its specifications, replace the unit. For a replacement kit, contact the nearest Johnson Controls representative.



VG2x31 Valves with M9000 Series Electric Valve Actuators

Selection Chart

Valve Size, in.	Valve Code Number	Discontinued Valve Code Numbers That Are Compatible with Linkage Kit	Nominal Valve Stroke, in.	Valve Stem Diameter, in.	Actuator Series ¹	Number of Actuators Required	Linkage Kit Code Number
2-1/2	VG2231TM VG2431TM VG2831TM	V-5252-4, -5, -6, -7, -8, -32, -33 V-5462-6, -7, -34 V-5842-7, -8, -31 VB-3752-19 VB-3970-11 VB-4322-9	3/4	3/8	M9116 M9124 M9220	1	M9000-530 ²
3	Not Applicable	V-5252-9, -10, -11, -34			M9124 M9220		M9000-530
3	VG2231UM VG2431UM VG2831UM	V5252-12, -13, -35 V-5462-8, -9, -35 V-5842-9, -10, -32 VB-3752-22 VB-3970-14 VB-4322-11	1-1/8		M9116 M9124 M9220	1	M9000-531 ³
						2	M9000-532
	VG2231UN VG2431UN VG2831UN	V-5462-10, -36 V-5842-17, -18, -33		1/2	M9124 M9220		M9000-537
4	VG2231VM VG2431VM VG2831VM	V-5252-14, -36 V-5462-11, -12, -37 V-5842-9, -10, -32 VB-3752-25 VB-3970-17 VB-4322-13		3/8		1	M9000-531 ³
						2	M9000-532
	VG2231VN VG2431VN VG2831VN	V-5252-15, -16, -37 V-5462-13, -14, -38 V-5842-11, -12, -34		1/2			M9000-537
5	VG2231WN VG2431WN VG2831WN	V-5252-17, -18, -38 V-5462-15, -16, -39 V-5842-13, -14, -35 VB-3752-28 VB-3970-20 VB-4322-19	1-3/8			1	M9000-533 ³
						2	M9000-534
6	VG2231YN VG2431YN VG2831YN	V-5252-19, -39 V-5462-17, -18, -40 V-5842-15, -16, -36 VB-3752-31 VB-3970-23 VB-4322-18	1-1/2			1	M9000-535 ³
						2	M9000-536

1. M9116 and M9124 Series Electric Actuators are non-spring return. M9220 Series Electric Actuators are spring return.
 2. The M9000-530 cannot be retrofitted with the M9000-610 Tandem Adapter Kit.
 3. Linkages can be retrofitted with a tandem actuator using an M9100-610 Tandem Adapter Kit.

M9000-53x Series Cast Iron Flanged Valve Linkage Kits (Continued)

Technical Specifications

M9000-53x Series Cast Iron Flanged Valve Linkage Kits		
Force Output	M9000-530	378 lb (1,684 N) Minimum with M9116 Series Actuator 605 lb (2,691 N) Minimum with M9124 Series Actuator 457 lb (2,035 N) Minimum with M9220 Series Actuator
	M9000-531	238 lb (1,060 N) Minimum with M9116 Series Actuator 380 lb (1,694 N) Minimum with M9124 Series Actuator 288 lb (1,281 N) Minimum with M9220 Series Actuator
	M9000-532	761 lb (3,385 N) Minimum with Tandem M9124 Series Actuators 576 lb (2,562 N) Minimum with Tandem M9220 Series Actuators
	M9000-533	315 lb (1,405 N) Minimum with M9124 Series Actuator
	M9000-534	631 lb (2,806 N) Minimum with Tandem M9124 Series Actuators 477 lb (2,121 N) Minimum with Tandem M9220 Series Actuators
	M9000-535	280 lb (1,248 N) Minimum with M9124 Series Actuator
	M9000-536	561 lb (2,495 N) Minimum with Tandem M9124 Series Actuators 424 lb (1,887 N) Minimum with Tandem M9220 Series Actuators
	M9000-537	761 lb (3,385 N) Minimum with Tandem M9124 Series Actuators 576 lb (2,562 N) Minimum with Tandem M9220 Series Actuators
Valve Stroke	M9000-530	3/4 in. (19 mm) Nominal
	M9000-531	1-1/8 in. (29 mm) Nominal
	M9000-532	1-1/8 in. (29 mm) Nominal
	M9000-533	1-3/8 in. (35 mm) Nominal
	M9000-534	1-3/8 in. (35 mm) Nominal
	M9000-535	1-1/2 in. (38 mm) Nominal
	M9000-536	1-1/2 in. (38 mm) Nominal
	M9000-537	1-1/8 in. (29 mm) Nominal
Minimum Ambient Operating Temperature (Limited by the Valve)	35°F (2°C) in Water and Steam Applications	
Maximum Ambient Operating Temperature ¹ (Limited by the Actuator)	122°F (50°C) M91xx Series Actuators 131°F (55°C) M9220 Series Actuators	
Shipping Weight	7-1/2 lb (3.4 kg)	

1. In steam applications, install the valve with the stem horizontal to the piping, and wrap the valve with insulation.

VG2000 Series Cast Iron Flanged Globe Valves, Maintenance and Repair

Selection Chart

Code Number	Description	Ship Weight, lb ¹
Packing Kits		
V-9999-613	For 2-1/2 in. through 4 in. Valves with 3/8 in. Stem. Kit Includes: Two Ring Packs (U-Cup with O-Ring Installed), One Follower, One Spacer, Insertion/Removal Tool, One Grease Tube, and One 3 in. (.76 mm) Strip of Crocus Cloth.	0.1
V-5252-668	For 3 in. through 6 in. Valves with 1/2 in. Stem. Kit Includes: Two Ring Packs (U-Cup with O-Ring Installed), One Follower, One Spacer Insertion/Removal Tool, One Grease Tube, and One 3 in. (.76 mm) Strip of Crocus Cloth.	0.2
Packing Nut Kits (Pneumatically Actuated Assemblies Only)		
V-4510-6019	For 2-1/2 in. through 4 in Valves with 3/8 in. Stem	0.1
V-5252-609	For 3 in. through 6 in. Valves with 1/2 in. Stem	0.4
Valve Reconditioning Kits		
V-5252-6001	Reconditioning Kit, 2-1/2 in. N.O. Flanged Valve, M Stem (3/8 in.), for Use with MP84 Pneumatic Actuator or Electric Actuator, Cv = 51.0; Includes: Bonnet and Packing Items, Stem and Disk Assembly, Packing Tools, Gasket and Screw Set, and Grease Packet.	7.0
V-5252-6002	Reconditioning Kit, 2-1/2 in. N.O. Flanged Valve, L Stem (3/8 in.), for Use with MP82 Pneumatic Actuator, Cv = 51.0; Includes: Bonnet and Packing Items, Stem and Disk Assembly, Packing Tools, Gasket and Screw Set, and Grease Packet.	6.9
V-5252-6003	Reconditioning Kit, 3 in. N.O. Flanged Valve, M Stem (3/8 in.), for Use with MP84 Pneumatic Actuator or Electric Actuator, Cv = 83.0; Includes: Bonnet and Packing Items, Stem and Disk Assembly, Packing Tools, Gasket and Screw Set, and Grease Packet.	9.5
V-5252-6004	Reconditioning Kit, 3 in. N.O. Flanged Valve, L Stem (3/8 in.), for Use with MP82 Pneumatic Actuator; Cv = 83.0; Includes: Bonnet and Packing Items, Stem and Disk Assembly, Packing Tools, Gasket and Screw Set, and Grease Packet.	9.5
V-5252-6005	Reconditioning Kit, 4 in. N.O. Flanged Valve, M Stem (3/8 in.), for Use with MP84 Pneumatic Actuator or Electric Actuator, Cv = 150.0; Includes: Bonnet and Packing Items, Stem and Disk Assembly, Packing Tools, Gasket and Screw Set, Grease Packet.	15.0
V-5252-6006	Reconditioning Kit, 4 in. N.O. Flanged Valve, N Stem (1/2 in.), for Use with MP86 Pneumatic Actuator, Cv = 150.0; Includes: Bonnet and Packing Items, Stem and Disk Assembly, Packing Tools, Gasket and Screw Set, and Grease Packet.	16.5
V-5252-6007	Reconditioning Kit, 5 in. N.O. Flanged Valve, N Stem (1/2 in.), for Use with MP86 Pneumatic Actuator, Cv = 240.0; Includes: Bonnet and Packing Items, Stem and Disk Assembly, Packing Tools, Gasket and Screw Set, and Grease Packet.	22.0
V-5252-6008	Reconditioning Kit, 6 in. N.O. Flanged Valve, N Stem (1/2 in.), for Use with MP86 Pneumatic Actuator, Cv = 350.0; Includes: Bonnet and Packing Items, Stem and Disk Assembly, Packing Tools, Gasket and Screw Set, and Grease Packet.	30.6
V-5462-6001	Reconditioning Kit, 2-1/2 in. N.C. Flanged Valve, M Stem (3/8 in.), for Use with MP84 Pneumatic Actuator or Electric Actuator, Cv = 54.0; Includes: Bonnet and Packing Items, Stem and Disk Assembly, Packing Tools, Gasket and Screw Set, and Grease Packet.	7.4
V-5462-6002	Reconditioning Kit, 3 in. N.C. Flanged Valve, M Stem (3/8 in.), for Use with MP84 Pneumatic Actuator or Electric Actuator, Cv = 83.0; Includes: Bonnet and Packing Items, Stem and Disk Assembly, Packing Tools, Gasket and Screw Set, and Grease Packet.	9.9
V-5462-6003	Reconditioning Kit, 3 in. N.C. Flanged Valve, N Stem (1/2 in.), for Use with MP86 Pneumatic Actuator, Cv = 83.0; Includes: Bonnet and Packing Items, Stem and Disk Assembly, Packing Tools, Gasket and Screw Set, and Grease Packet.	12.7
V-5462-6004	Reconditioning Kit, 4 in. N.C. Flanged Valve, M Stem (3/8 in.), for Use with MP84 Pneumatic Actuator or Electric Actuator, Cv = 150.0; Includes: Bonnet and Packing Items, Stem and Disk Assembly, Packing Tools, Gasket and Screw Set, Grease Packet.	16.3
V-5462-6005	Reconditioning Kit, 4 in. N.C. Flanged Valve, N Stem (1/2 in.), for Use with MP86 Pneumatic Actuator, Cv = 150.0; Includes: Bonnet and Packing Items, Stem and Disk Assembly, Packing Tools, Gasket and Screw Set, and Grease Packet.	17.4
V-5462-6006	Reconditioning Kit, 5 in. N.C. Flanged Valve, N Stem, (1/2 in.), for Use with MP86 Pneumatic Actuator, Cv = 237.0; Includes: Bonnet and Packing Items, Stem and Disk Assembly, Packing Tools, Gasket and Screw Set, and Grease Packet.	23.7
V-5462-6007	Reconditioning Kit, 6 in. N.C. Flanged Valve, N Stem (1/2 in.), for Use with MP86 Pneumatic Actuator, Cv = 344.0; Includes: Bonnet and Packing Items, Stem and Disk Assembly, Packing Tools, Gasket and Screw Set, and Grease Packet.	31.1
V-5842-6001	Reconditioning Kit, 2-1/2 in. Three-Way Mixing Flanged Valve, M Stem (3/8 in.), for Use with MP84 Pneumatic Actuator or Electric Actuator, Cv = 54.0; Includes: Bonnet and Packing Items, Stem and Disk Assembly, Packing Tools, Gasket and Screw Set, and Grease Packet.	8.1
V-5842-6002	Reconditioning Kit, 3 in. Three-Way Mixing Flanged Valve, M Stem (3/8 in.), for Use with MP84 Pneumatic Actuator or Electric Actuator, Cv = 80.0; Includes: Bonnet and Packing Items, Stem and Disk Assembly, Packing Tools, Gasket and Screw Set, and Grease Packet.	10.8
V-5842-6003	Reconditioning Kit, 3 in. Three-Way Mixing Flanged Valve, N Stem (1/2 in.), for Use with MP86 Pneumatic Actuator, Cv = 80.0; Includes: Bonnet and Packing Items, Stem and Disk Assembly, Packing Tools, Gasket and Screw Set, and Grease Packet.	12.3
V-5842-6004	Reconditioning Kit, 4 in. Three-Way Mixing Flanged Valve, for Use with Electric Actuator, Cv = 157.0; Includes: Bonnet and Packing Items, Stem and Disk Assembly, Packing Tools, Gasket and Screw Set, and Grease Packet.	16.6
V-5842-6005	Reconditioning Kit, 4 in. Three-Way Mixing Flanged Valve, N Stem (1/2 in.), for Use with MP86 Pneumatic Actuator, Cv = 157.0; Includes: Bonnet and Packing Items, Stem and Disk Assembly, Packing Tools, Gasket and Screw Set, and Grease Packet.	17.8
V-5842-6006	Reconditioning Kit, 5 in. Three-Way Mixing Flanged Valve, N Stem (1/2 in.), for Use with MP86 Pneumatic Actuator, Cv = 238.0; Includes: Bonnet and Packing Items, Stem and Disk Assembly, Packing Tools, Gasket and Screw Set, and Grease Packet.	22.0
V-5842-6007	Reconditioning Kit, 6 in. Three-Way Mixing Flanged Valve, N Stem (1/2 in.), for Use with MP86 Pneumatic Actuator, Cv = 347.0; Includes: Bonnet and Packing Items, Stem and Disk Assembly, Packing Tools, Gasket and Screw Set, and Grease Packet.	31.9

1. lb x 0.454 = kg.

The performance specifications are nominal and conform to acceptable industry standards. For applications at conditions beyond these specifications, consult the local Johnson Controls office. Johnson Controls shall not be liable for damages resulting from misapplication or misuse of its products. © 2019 Johnson Controls. www.johnsoncontrols.com

M9000 Electrically Actuated, Standard-Pressure, Standard-Temperature, Two-Way Butterfly Valves (without Weather Shield)

Description

VF Series M9000 Electrically Actuated, Standard-Pressure, Standard-Temperature, Two-Way Butterfly Valves are specifically designed for a wide range of HVAC applications, including two-position and modulating control of hot, chilled, or condenser water, and 50/50 glycol solutions. These valves are also bidirectional, allowing positive shutoff with the flow in either direction.

Two-way configurations are available in sizes 2 through 6 in. non-spring return, and 2 through 5 in. spring return. M9000 electrically actuated, non-weather shield models feature an integral handle for manual positioning of the valve, independent of a power supply.

Refer to the *VF Series Standard-Pressure, Standard-Temperature Butterfly Valves Product Bulletin (LIT-977205P)* for important product application information.

Features

- low seating/unseating torques
- bubble-tight shutoff
- broad range of pre-assembled actuators
- compatible with all types of American National Standards Institute (ANSI) 125/150 slip-on and weld-neck flanges
- high-integrity components
- M9000 electric actuators available with or without a rugged, factory-installed weather shield
- M9000 electric actuators available with or without end switches

Repair Information

If the VF Series Butterfly Valve fails to operate within its specifications, refer to the *VF Series Standard-Pressure, Standard-Temperature Butterfly Valves Product Bulletin (LIT-977205P)* for a list of repair parts available.



Two-Way Valve with M9000 Series Spring-Return Electric Actuator (without Weather Shield)

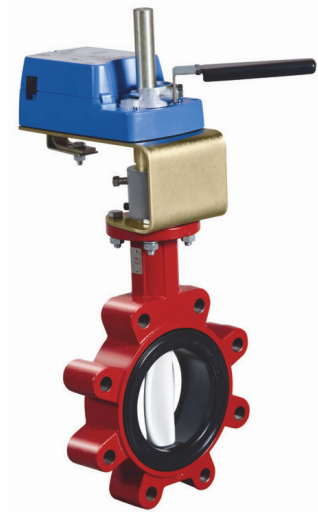

Two-Way Valve with M9000 Series Non-Spring-Return Electric Actuator (without Weather Shield)

Selection Chart

M9000 Electrically Actuated, Standard-Pressure, Standard-Temperature, Two-Way Butterfly Valves (without Weather Shield) (Part 1 of 2)

Valve Code Number	Size, in.	Cv at 90°	Cv at 60°	Closeoff Pressure, psig ¹	Two-Way Butterfly Valves (without Weather Shield)							
					Two-Way — Spring Return							
					Spring Open		Spring Closed		Spring Open		Spring Closed	
					Floating Control							
					M9220-AGA-3 without End Switches				M9220-AGC-3 with Two End Switches			
VFN020HB	2	144	61	175	VFN020HB+92NAGA	VFC020HB+94NAGA	VFN020HB+92NAGC	VFC020HB+94NAGC				
VFN025HB	2-1/2	282	107	175	VFN025HB+92NAGA	VFC025HB+94NAGA	VFN025HB+92NAGC	VFC025HB+94NAGC				
VFN030HB	3	461	154	175	VFN030HB+92NAGA	VFC030HB+94NAGA	VFN030HB+92NAGC	VFC030HB+94NAGC				
VFN040LB	4	841	247	50	VFN040LB+92NAGA	VFC040LB+94NAGA	VFN040LB+92NAGC	VFC040LB+94NAGC				
VFN040HB	4	841	247	175	VFN040HB292NAGA ²	VFC040HB294NAGA ²	VFN040HB292NAGC ²	VFC040HB294NAGC ²				
VFN050LB	5	1376	428	50	VFN050LB292NAGA ²	VFC050LB294NAGA ²	VFN050LB292NAGC ²	VFC050LB294NAGC ²				
					On/Off							
					M9220-BGA-3 without End Switches				M9220-BGC-3 with Two End Switches			
VFN020HB	2	144	61	175	VFN020HB+92NBGA	VFC020HB+94NBGA	VFN020HB+92NBGC	VFC020HB+94NBGC				
VFN025HB	2-1/2	282	107	175	VFN025HB+92NBGA	VFC025HB+94NBGA	VFN025HB+92NBGC	VFC025HB+94NBGC				
VFN030HB	3	461	154	175	VFN030HB+92NBGA	VFC030HB+94NBGA	VFN030HB+92NBGC	VFC030HB+94NBGC				
VFN040LB	4	841	247	50	VFN040LB+92NBGA	VFC040LB+94NBGA	VFN040LB+92NBGC	VFC040LB+94NBGC				
VFN040HB	4	841	247	175	VFN040HB292NBGA ²	VFC040HB294NBGA ²	VFN040HB292NBGC ²	VFC040HB294NBGC ²				
VFN050LB	5	1376	428	50	VFN050LB292NBGA ²	VFC050LB294NBGA ²	VFN050LB292NBGC ²	VFC050LB294NBGC ²				

The performance specifications are nominal and conform to acceptable industry standards. For applications at conditions beyond these specifications, consult the local Johnson Controls office. Johnson Controls shall not be liable for damages resulting from misapplication or misuse of its products. © 2019 Johnson Controls. www.johnsoncontrols.com

M9000 Electrically Actuated, Standard-Pressure, Standard-Temperature, Two-Way Butterfly Valves (without Weather Shield) (Continued)

M9000 Electrically Actuated, Standard-Pressure, Standard-Temperature, Two-Way Butterfly Valves (without Weather Shield)
(Part 2 of 2)

Valve Code Number	Size, in.	Cv at 90°	Cv at 60°	Closeoff Pressure, psig ¹	Two-Way Butterfly Valves (without Weather Shield)			
					0 to 10 VDC Proportional Control			
					M9220-GGA-3 without End Switches		M9220-GGC-3 with Two End Switches	
VFN020HB	2	144	61	175	VFN020HB+92NGGA	VFC020HB+94NGGA	VFN020HB+92NGGC	VFC020HB+94NGGC
VFN025HB	2-1/2	282	107	175	VFN025HB+92NGGA	VFC025HB+94NGGA	VFN025HB+92NGGC	VFC025HB+94NGGC
VFN030HB	3	461	154	175	VFN030HB+92NGGA	VFC030HB+94NGGA	VFN030HB+92NGGC	VFC030HB+94NGGC
VFN040LB	4	841	247	50	VFN040LB+92NGGA	VFC040LB+94NGGA	VFN040LB+92NGGC	VFC040LB+94NGGC
VFN040HB	4	841	247	175	VFN040HB292NGGA ²	VFC040HB294NGGA ²	VFN040HB292NGGC ²	VFC040HB294NGGC ²
VFN050LB	5	1376	428	50	VFN050LB292NGGA ²	VFC050LB294NGGA ²	VFN050LB292NGGC ²	VFC050LB294NGGC ²
					Two-Way — Non-Spring Return			
					On/Off (Floating) Control		0 to 10 VDC Proportional Control	
					M91xx-AGA-2 without Switches	M91xx-AGC-2 with Two Switches	M91xx-GGA-2 without Switches	M91xx-GGC-2 with Two Switches
VFN020HB	2	144	61	175	VFN020HB+916AGA	VFN020HB+916AGC	VFN020HB+916GGA	VFN020HB+916GGC
VFN025HB	2-1/2	282	107	175	VFN025HB+916AGA	VFN025HB+916AGC	VFN025HB+916GGA	VFN025HB+916GGC
VFN030HB	3	461	154	175	VFN030HB+916AGA	VFN030HB+916AGC	VFN030HB+916GGA	VFN030HB+916GGC
VFN040HB	4	841	247	175	VFN040HB+924AGA	VFN040HB+924AGC	VFN040HB+924GGA	VFN040HB+924GGC
VFN050LB	5	1376	428	50	VFN050LB+924AGA	VFN050LB+924AGC	VFN050LB+924GGA	VFN050LB+924GGC
VFN050HB	5	1376	428	175	VFN050HB2924AGA ²	VFN050HB2924AGC ²	VFN050HB2924GGA ²	VFN050HB2924GGC ²
VFN060LB	6	1850	576	50	VFN060LB2924AGA ²	VFN060LB2924AGC ²	VFN060LB2924GGA ²	VFN060LB2924GGC ²

1. Valves rated for 175 psig closeoff have 75 psig maximum dead-end service rating. Valves rated for 50 psig closeoff are not rated for dead-end service.
2. Valve assemblies have two actuators mounted in tandem.

M9000 Electrically Actuated, Standard-Pressure, Standard-Temperature, Two-Way Butterfly Valves (without Weather Shield)

Valve Code Number	Size, in.	Cv at 90°	Cv at 70°	Closeoff Pressure, psig ¹	Two-Way Butterfly Valves (without Weather Shield)	
					Two-Way — Non Spring Return	
					Automatic Signal Detection Floating On/Off, Proportional	
					M93xx-HGC-2 Without End Switches	M93xx-HGC-2 With Two End Switches
VFN020HB	2	144	84	175	VFN020HB+920HGA	VFN020HB+920HGC
VFN025HB	2-1/2	282	163	175	VFN025HB+920HGA	VFN025HB+920HGC
VFN030HB	3	461	267	175	VFN030HB+920HGA	VFN030HB+920HGC
VFN040LB	4	841	496	175	VFN040HB+935HGA	VFN040HB+935HGC
VFN040HB	4	841	496	50	VFN040LB+920HGA	VFN040LB+920HGC
VFN050HB	5	1376	775	175	VFN050HB2935HGA ²	VFN050HB2935HGC ²
VFN050LB	5	1376	775	50	VFN050LB+935HGA	VFN050LB+935HGC
VFN060HB	6	1850	1025	175	VFN060HB2935HGA ²	VFN060HB2935HGC ²
VFN060NB	6	1850	1025	50	VFN060NB+935HGA	VFN060NB+935HGC
VFN080NB	8	3316	1862	50	VFN080NB+935HGA	VFN080NB+935HGC

1. Valves rated for 175 psig closeoff have 75 psig maximum dead-end service rating. Valves rated for 50 psig closeoff are not rated for dead-end service.
2. Valve assemblies have two actuators mounted in tandem.

M9000 Electrically Actuated, Standard-Pressure, Standard-Temperature, Two-Way Butterfly Valves (without Weather Shield) (Continued)
Technical Specifications

M9000 Electrically Actuated, Standard-Pressure, Standard-Temperature, Two-Way Butterfly Valves (without Weather Shield)¹		
Service	Hot, Chilled, or Condenser Water, and 50/50 Glycol Solutions (Not Designed for Use in Steam Applications)	
Body Styles and Sizes	Two-Way, 2 through 6 in., Fully Lugged	
Fluid Temperature Limits	-20°F to 250°F (-29°C to 121°C)	
Body Pressure Rating	175 psig	
Maximum Fluid Velocity	30 ft/second (9 m/second)	
Rangeability	Refer to the <i>VF Series Standard-Pressure, Standard-Temperature Butterfly Valves Product Bulletin (LIT-977205P)</i> .	
Leakage	Bubble Tight	
Flow Characteristics	Modified Equal Percentage	
Materials	Body	Cast Iron ASTM A126 Class B
	Tee (Three-Way Valves Only)	Cast Iron
	Disc	Ductile Iron, Nylon 11 Coated, ASTM A536 Gr 65-45-12
	Seat	Ethylene Propylene Diene Monomer (EPDM)
	Stem	416 Stainless Steel
Ambient Temperature Limits	Storage	-20°F to 150°F (-29°C to 66°C), Preferably 40°F to 85 F (4°C to 29°C)
	Operating	Spring-Return Actuator: -20°F to 131°F (-29°C to 55°C) Non-Spring-Return Actuator: -4°F to 122°F (-20°C to 50°C)

1. Refer to the *VF Series Standard-Pressure, Standard-Temperature Butterfly Valves Product Bulletin (LIT-977205P)* for actuator specifications.

M9000 Electrically Actuated, Standard-Pressure, Standard-Temperature, Two-Way Butterfly Valves (with Weather Shield)

Description

VF Series M9000 Electrically Actuated, Standard-Pressure, Standard-Temperature, Two-Way Butterfly Valves are specifically designed for a wide range of HVAC applications, including two-position and modulating control of hot, chilled, or condenser water, and 50/50 glycol solutions. These valves are also bidirectional, allowing positive shutoff with the flow in either direction.

Two-way configurations are available in sizes 2 through 6 in. non-spring return, and 2 through 5 in. spring return. M9000 electrically actuated, weather shield models feature an integral handle for manual positioning of the valve, independent of a power supply.

Refer to the *VF Series Standard-Pressure, Standard-Temperature Butterfly Valves Product Bulletin (LIT-977205P)* for important product application information.

Features

- low seating/unseating torques
- bubble-tight shutoff
- broad range of pre-assembled actuators
- compatible with all types of American National Standards Institute (ANSI) 125/150 slip-on and weld-neck flanges
- high-integrity components
- M9000 electric actuators available with or without a rugged, factory-installed weather shield
- M9000 electric actuators available with or without end switches

Repair Information

If the VF Series Butterfly Valve fails to operate within its specifications, refer to the *VF Series Standard-Pressure, Standard-Temperature Butterfly Valves Product Bulletin (LIT-977205P)* for a list of repair parts available.



Two-Way Valve with M9000 Series Electric Actuator (with Weather Shield)

Selection Chart

M9000 Electrically Actuated, Standard-Pressure, Standard-Temperature, Two-Way Butterfly Valves (with Weather Shield)
(Part 1 of 2)

Valve Code Number	Size, in.	Cv at 90°	Cv at 70°	Closeoff Pressure, psig ¹	Two-Way Valve with M9000 Series Electric Actuator (with Weather Shield)			
					Spring Open	Spring Closed	Spring Open	Spring Closed
Spring Return — Floating Control								
M9220-AGA-3 without End Switches								
M9220-AGC-3 with 2 End Switches								
VWN020HB	2	144	84	175	VWN020HB+92NAGA	VWC020HB+94NAGA	VWN020HB+92NAGC	VWC020HB+94NAGC
VWN025HB	2-1/2	282	163	175	VWN025HB+92NAGA	VWC025HB+94NAGA	VWN025HB+92NAGC	VWC025HB+94NAGC
VWN030HB	3	461	267	175	VWN030HB+92NAGA	VWC030HB+94NAGA	VWN030HB+92NAGC	VWC030HB+94NAGC
VWN040LB	4	841	496	50	VWN040LB+92NAGA	VWC040LB+94NAGA	VWN040LB+92NAGC	VWC040LB+94NAGC
VWN040HB	4	841	496	175	VWN040HB292NAGA ²	VWC040HB294NAGA ²	VWN040HB292NAGC ²	VWC040HB294NAGC ²
VWN050LB	5	1,376	775	50	VWN050LB292NAGA ²	VWC050LB294NAGA ²	VWN050LB292NAGC ²	VWC050LB294NAGC ²
Spring Return — On/Off								
M9220-BGA-3 without End Switches								
M9220-BGC-3 with 2 End Switches								
VWN020HB	2	144	84	175	VWN020HB+92NBGA	VWC020HB+94NBGA	VWN020HB+92NBGC	VWC020HB+94NBGC
VWN025HB	2-1/2	282	163	175	VWN025HB+92NBGA	VWC025HB+94NBGA	VWN025HB+92NBGC	VWC025HB+94NBGC
VWN030HB	3	461	267	175	VWN030HB+92NBGA	VWC030HB+94NBGA	VWN030HB+92NBGC	VWC030HB+94NBGC
VWN040LB	4	841	496	50	VWN040LB+92NBGA	VWC040LB+94NBGA	VWN040LB+92NBGC	VWC040LB+94NBGC
VWN040HB	4	841	496	175	VWN040HB292NBGA ²	VWC040HB294NBGA ²	VWN040HB292NBGC ²	VWC040HB294NBGC ²
VWN050LB	5	1,376	775	50	VWN050LB292NBGA ²	VWC050LB294NBGA ²	VWN050LB292NBGC ²	VWC050LB294NBGC ²
Spring Return — 0 to 10 VDC Proportional Control								
M9220-GGA-3 without End Switches								
M9220-GGC-3 with 2 End Switches								
VWN020HB	2	144	84	175	VWN020HB+92NGGA	VWC020HB+94NGGA	VWN020HB+92NGGC	VWC020HB+94NGGC
VWN025HB	2-1/2	282	163	175	VWN025HB+92NGGA	VWC025HB+94NGGA	VWN025HB+92NGGC	VWC025HB+94NGGC
VWN030HB	3	461	267	175	VWN030HB+92NGGA	VWC030HB+94NGGA	VWN030HB+92NGGC	VWC030HB+94NGGC
VWN040LB	4	841	496	50	VWN040LB+92NGGA	VWC040LB+94NGGA	VWN040LB+92NGGC	VWC040LB+94NGGC
VWN040HB	4	841	496	175	VWN040HB292NGGA ²	VWC040HB294NGGA ²	VWN040HB292NGGC ²	VWC040HB294NGGC ²
VWN050LB	5	1,376	775	50	VWN050LB292NGGA ²	VWC050LB294NGGA ²	VWN050LB292NGGC ²	VWC050LB294NGGC ²

The performance specifications are nominal and conform to acceptable industry standards. For applications at conditions beyond these specifications, consult the local Johnson Controls office. Johnson Controls shall not be liable for damages resulting from misapplication or misuse of its products. © 2019 Johnson Controls. www.johnsoncontrols.com

M9000 Electrically Actuated, Standard-Pressure, Standard-Temperature, Two-Way Butterfly Valves (with Weather Shield) (Continued)

M9000 Electrically Actuated, Standard-Pressure, Standard-Temperature, Two-Way Butterfly Valves (with Weather Shield)
(Part 2 of 2)

Valve Code Number	Size, in.	Cv at 90°	Cv at 70°	Closeoff Pressure, psig ¹	Two-Way Valve with M9000 Series Electric Actuator (with Weather Shield)			
					Spring Open	Spring Closed	Spring Open	Spring Closed
					Two-Way — Non-Spring Return			
					On/Off (Floating) Control		0 to 10 VDC Proportional Control	
					M91xx-AGA-2 without switches	M91xx-AGC-2 with 2 Switches	M91xx-GGA-2 without switches	M91xx-GGC-2 with 2 Switches
VWN020HB	2	144	84	175	VWN020HB+916AGA	VWN020HB+916AGC	VWN020HB+916GGA	VWN020HB+916GGC
VWN025HB	2-1/2	282	163	175	VWN025HB+916AGA	VWN025HB+916AGC	VWN025HB+916GGA	VWN025HB+916GGC
VWN030HB	3	461	267	175	VWN030HB+916AGA	VWN030HB+916AGC	VWN030HB+916GGA	VWN030HB+916GGC
VWN040HB	4	841	496	175	VWN040HB+924AGA	VWN040HB+924AGC	VWN040HB+924GGA	VWN040HB+924GGC
VWN050LB	5	1376	775	50	VWN050LB+924AGA	VWN050LB+924AGC	VWN050LB+924GGA	VWN050LB+924GGC
VWN050HB	5	1376	775	175	VWN050HB2924AGA ²	VWN050HB2924AGC ²	VWN050HB2924GGA ²	VWN050HB2924GGC ²
VWN060LB	6	1850	1025	50	VWN060LB2924AGA ²	VWN060LB2924AGC ²	VWN060LB2924GGA ²	VWN060LB2924GGC ²
					Two-Way — Non-Spring Return			
					Automatic Signal Detection Floating, On/Off, Proportional			
					M93xx-HGC-2 Without End Switches	M93xx-HGC-2 With Two End Switches		
VWN020HB	2	144	84	175	VWN020HB+920HGA	VWN020HB+920HGC		
VWN025HB	2-1/2	282	163	175	VWN025HB+920HGA	VWN025HB+920HGC		
VWN030HB	3	461	267	175	VWN030HB+920HGA	VWN030HB+920HGC		
VWN040HB	4	841	496	175	VWN040HB+935HGA	VWN040HB+935HGC		
VWN040LB	4	841	496	50	VWN040LB+920HGA	VWN040LB+920HGC		
VWN050HB	5	1376	775	175	VWN050HB2935HGA ²	VWN050HB2935HGC ²		
VWN050LB	5	1376	775	50	VWN050LB+935HGA	VWN050LB+935HGC		
VWN060HB	6	1850	1025	175	VWN060HB2935HGA ²	VWN060HB2935HGC ²		
VWN060NB	6	1850	1025	50	VWN060NB+935HGA	VWN060NB+935HGC		
VWN080NB	8	3316	1862	50	VWN080NB+935HGA	VWN080NB+935HGC		

1. Valves rated for 175 psig closeoff have 75 psig maximum dead-end service rating. Valves rated for 50 psig closeoff are not rated for dead-end service.
2. Valve assemblies have two actuators mounted in tandem.

Technical Specifications

M9000 Electrically Actuated, Standard-Pressure, Standard-Temperature, Two-Way Butterfly Valves (with Weather Shield) ¹		
Service	Hot, Chilled, or Condenser Water, and 50/50 Glycol Solutions (Not Designed for Use in Steam Applications)	
Body Styles and Sizes	Two-Way, 2 through 6 in., Fully Lugged	
Fluid Temperature Limits	-20°F to 250°F (-29°C to 121°C)	
Body Pressure Rating	175 psig	
Maximum Fluid Velocity	30 ft/second (9 m/second)	
Rangeability	Refer to the <i>VF Series Standard-Pressure, Standard-Temperature Butterfly Valves Product Bulletin (LIT-977205P)</i> .	
Leakage	Bubble Tight	
Flow Characteristics	Modified Equal Percentage	
Materials	Body	Cast Iron ASTM A126 Class B
	Tee (Three-Way Valves Only)	Cast Iron
	Disc	Ductile Iron, Nylon 11 Coated, ASTM A536 Gr 65-45-12
	Seat	Ethylene Propylene Diene Monomer (EPDM)
	Stem	416 Stainless Steel
Ambient Temperature Limits	Storage	-20°F to 150°F (-29°C to 66°C), Preferably 40°F to 85°F (4°C to 29°C)
	Operating	Spring-Return Actuator: -20°F to 131°F (-29°C to 55°C) Non-Spring-Return Actuator: -4°F to 122°F (-20°C to 50°C)
Weather Shield Rating	National Electrical Manufacturers' Association (NEMA) 4	

1. Refer to the *VF Series Standard-Pressure, Standard-Temperature Butterfly Valves Product Bulletin (LIT-977205P)* for actuator specifications.

VF Series Two-Way, Industrial-Grade, Non-Spring Return, VA-907x Series Electric Actuated, Standard-Pressure, Standard-Temperature Butterfly Valve Assemblies

Description

VF Series Two-Way, Industrial-Grade, Non-Spring Return, VA-907x Series Electric Actuated, Standard-Pressure, Standard-Temperature Butterfly Valves are specifically designed for a wide range of Heating, Ventilating, and Air Conditioning (HVAC) applications, including two-position and modulating control of hot, chilled, or condenser water, and 50/50 glycol solutions. All valves are factory tested for bubble-tight shutoff at 100% of the fully-rated pressure. These valves are bidirectional, allowing positive shutoff with the flow in either direction. Refer to the *VF Series Standard-Pressure, Standard-Temperature Butterfly Valves Product Bulletin (LIT-977205P)* for important product application information.

- compatible with all types of American National Standards Institute (ANSI) 125/150 slip-on and weld-neck flanges
- high-integrity components

Repair Information

If the Two-Way, Industrial-Grade, Non-Spring Return, VA-90xx Series Electric Actuated, Standard-Pressure, Standard-Temperature Butterfly Valve fails to operate within its specifications, refer to the *VF Series Standard-Pressure, Standard-Temperature Butterfly Valves Product Bulletin (LIT-977205P)* for a list of repair parts available.



Two-Way, Industrial-Grade, Non-Spring Return, VA-90xx Series Electric Actuated, Standard-Pressure, Standard-Temperature Butterfly Valve Assemblies

Features

- low seating/unseating torques
- bubble-tight shutoff
- broad range of pre-assembled actuators

Selection Chart

Two-Way Valves with Industrial-Grade, Non-Spring Return, VA-90xx Series Electric Actuators

Actuator				AC 120 V Powered Actuator		AC 24 V Powered Actuator	
Size, in.	Cv at 90°	Cv at 60°	Closeoff Pressure psig	On/Off	0 VDC to 10 VDC Proportional	On/Off	0 VDC to 10 VDC Proportional
Two-Way, Non-Spring Return – 150 or 175 psig Closeoff Pressure; 75 psig Dead-End Service							
2	144	61	175	VFC-020HB-722D	VFC-020HB-702N	VFC-020HB-722D4	VFC-020HB-702N4
2-1/2	282	107	175	VFC-025HB-722D	VFC-025HB-702N	VFC-025HB-722D4	VFC-025HB-702N4
3	461	154	175	VFC-030HB-722D	VFC-030HB-702N	VFC-030HB-722D4	VFC-030HB-702N4
4	841	274	175	VFC-040HB-722D	VFC-040HB-702N	VFC-040HB-722D4	VFC-040HB-702N4
5	1,376	428	175	VFC-050HB-722D	VFC-050HB-702N	VFC-050HB-722D4	VFC-050HB-702N4
6	1,850	567	175	VFC-060HB-722D	VFC-060HB-702N	VFC-060HB-722D4	VFC-060HB-702N4
8	3,316	1,081	175	VFC-080HB-725D	VFC-080HB-705N	VFC-080HB-725D4	VFC-080HB-705N4
10	5,430	1,710	175	VFC-100HB-726D	VFC-100HB-706N	VFC-100HB-727D4	VFC-100HB-707N4
12	8,077	2,563	175	VFC-120HB-727D	VFC-120HB-707N	VFC-120HB-727D4	VFC-120HB-707N4
14	10,538	3,384	150	VFC-140HC-728D	VFC-140HC-708N	—	—
16	13,966	4,483	150	VFC-160HC-927D	VFC-160HC-907N	—	—
18	17,214	5,736	150	VFC-180HC-927D	VFC-180HC-907N	—	—
20	22,339	7,144	150	VFC-200HC-928D	VFC-200HC-908N	—	—
Two-Way, Non-Spring Return – 50 psig Closeoff Pressure; Not Rated for Dead-End Service							
4	841	274	50	VFC-040LB-722D	VFC-040LB-702N	VFC-040LB-722D4	VFC-040LB-702N4
5	1,376	428	50	VFC-050LB-722D	VFC-050LB-702N	VFC-050LB-722D4	VFC-050LB-702N4
6	1,850	567	50	VFC-060LB-722D	VFC-060LB-702N	VFC-060LB-722D4	VFC-060LB-702N4
8	3,316	1,081	50	VFC-080LB-723D	VFC-080LB-703N	VFC-080LB-725D4	VFC-080LB-705N4
10	5,430	1,710	50	VFC-100LB-725D	VFC-100LB-705N	VFC-100LB-725D4	VFC-100LB-705N4
12	8,077	2,563	50	VFC-120LB-726D	VFC-120LB-706N	VFC-120LB-727D4	VFC-120LB-707N4
14	10,538	3,384	50	VFC-140LC-726D	VFC-140LC-706N	VFC-140LC-727D4	VFC-140LC-707N4
16	13,966	4,483	50	VFC-160LC-727D	VFC-160LC-707N	VFC-160LC-727D4	VFC-160LC-707N4
18	17,214	5,736	50	VFC-180LC-727D	VFC-180LC-707N	—	—
20	22,339	7,144	50	VFC-200LC-728D	VFC-200LC-708N	—	—

The performance specifications are nominal and conform to acceptable industry standards. For applications at conditions beyond these specifications, consult the local Johnson Controls office. Johnson Controls shall not be liable for damages resulting from misapplication or misuse of its products. © 2019 Johnson Controls. www.johnsoncontrols.com

VF Series Two-Way, Industrial-Grade, Non-Spring Return, VA-907x Series Electric Actuated, Standard-Pressure, Standard-Temperature Butterfly Valve Assemblies (Continued)

Technical Specifications

Two-Way, Industrial-Grade, Non-Spring Return, VA-907x Series Electric Actuated, Standard-Pressure, Standard-Temperature Butterfly Valve Assemblies¹		
Service	Hot, Chilled, or Condenser Water, and 50/50 Glycol Solutions (Not designed for use in steam applications.)	
Body Styles and Sizes	Two-Way, 2 in. through 20 in., Fully Lugged	
Fluid Temperature Limits	-20°F to 250°F (-29°C to 121°C)	
Body Pressure Rating	250 psig (1723 kPa)	
Maximum Fluid Velocity	30 ft/second (9 m/second)	
Rangeability	Refer to the <i>VF Series Standard-Pressure, Standard-Temperature Butterfly Valves Product Bulletin (LIT-977205P)</i> .	
Leakage	Bubble Tight	
Flow Characteristics	Modified Equal Percentage	
Materials	Body	Cast Iron, ASTM A126 Class B
	Tee (Three-Way Valves Only)	Cast Iron
	Disc	Ductile Iron, Nylon 11 Coated, ASTM A536 Gr 65-45-12
	Seat	Ethylene Propylene Diene Monomer (EPDM)
	Stem	416 Stainless Steel (2 in. through 12 in.) 304 Stainless Steel (14 in. through 20 in.)
Ambient Temperature Limits	Storage	-20°F to 150°F (-29°C to 66°C), Preferably 40°F to 85°F (4°C to 29°C)
	Operating	-20°F to 150°F (-29°C to 65°C)
Enclosure Rating	National Electrical Manufacturers' Association (NEMA) 4	

1. Refer to the *VF Series Standard-Pressure, Standard-Temperature Butterfly Valves Product Bulletin (LIT-977205P)* for actuator specifications.

Two-Way, Spring-Return, Low-Pressure D-3000 Series Pneumatically Actuated, Standard-Pressure, Standard-Temperature Butterfly Valve Assemblies

Description

VF Series Two-Way, Spring-Return, Low-Pressure D-3000 Series Pneumatically Actuated, Standard-Pressure, Standard-Temperature Butterfly Valves are specifically designed for a wide range of HVAC applications, including two-position and modulating control of hot, chilled, or condenser water, and 50/50 glycol solutions. These valves are also bidirectional, allowing positive shutoff with the flow in either direction.

Refer to the *VF Series Standard-Pressure, Standard-Temperature Butterfly Valves Product Bulletin (LIT-977205P)* for important product application information.

Features

- low seating/unseating torques
- bubble-tight shutoff
- broad range of pre-assembled actuators
- compatible with all types of American National Standards Institute (ANSI) 125/150 slip-on and weld-neck flanges

- high-integrity components
- D-3000 Series pneumatic actuators available with or without a pneumatic positioner
- air supply pressure 20 psi minimum
- valve assemblies for on/off applications for valve actuator positioner, 30 psig maximum pressure rating
- valve assemblies for proportional applications standard with D-9502 valve actuator positioner, 25 psig maximum air pressure rating

Repair Information

If the VF Series Butterfly Valve Assembly fails to operate within its specifications, refer to the *VF Series Standard-Pressure, Standard-Temperature Butterfly Valves Product Bulletin (LIT-977205P)* for a list of repair parts available.

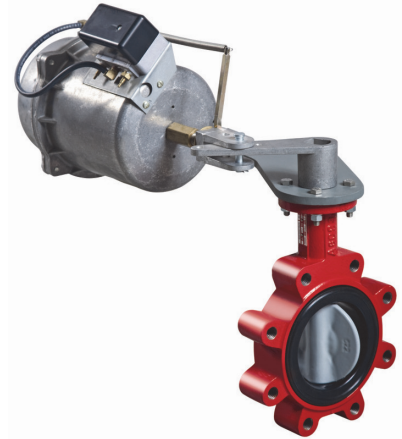

Two-Way, Spring-Return, Low-Pressure D-3000 Series Pneumatically Actuated, Standard-Pressure, Standard-Temperature Butterfly Valve Assemblies

Selection Chart

Valve Code Number	Size, in.	Cv at 70°	Closeoff Pressure, psig	On/Off (Proportional) Control		Proportional Control (with Positioner)	
				Spring Closed	Spring Open	Spring Closed	Spring Open
Two-Way Butterfly Valve Assemblies — 175 psig Closeoff Pressure — Rated for 75 psig Dead-End Service							
VFC-020HB	2	84	175	VFC-020HB-001N	VFN-020HB-001N	VFC-020HB-001A	VFN-020HB-001A
VFC-025HB	2-1/2	163	175	VFC-025HB-001N	VFN-025HB-001N	VFC-025HB-001A	VFN-025HB-001A
VFC-030HB	3	267	175	VFC-030HB-001N	VFN-030HB-001N	VFC-030HB-001A	VFN-030HB-001A
VFC-040HB	4	496	175	VFC-040HB-002N	VFN-040HB-002N	VFC-040HB-002A	VFN-040HB-002A
VFC-050HB	5	775	175	VFC-050HB-003N	VFN-050HB-003N	VFC-050HB-003A	VFN-050HB-003A
VFC-060HB	6	1,025	175	VFC-060HB-003N	VFN-060HB-003N	VFC-060HB-003A	VFN-060HB-003A
VFC-080HB	8	1,862	175	VFC-080HB-005N ¹	VFN-080HB-005N ¹	VFC-080HB-005A ¹	VFN-080HB-005A ¹
Two-Way Butterfly Valve Assemblies — 50 psig Closeoff Pressure — Not Rated for Dead-End Service							
VFC-040LB	4	496	50	VFC-040LB-001N	VFN-040LB-001N	VFC-040LB-001A	VFN-040LB-001A
VFC-050LB	5	775	50	VFC-050LB-002N	VFN-050LB-002N	VFC-050LB-002A	VFN-050LB-002A
VFC-060LB	6	1,025	50	VFC-060LB-003N	VFN-060LB-003N	VFC-060LB-003A	VFN-060LB-003A
VFC-080LB	8	1,862	50	VFC-080LB-003N	VFN-080LB-003N	VFC-080LB-003A	VFN-080LB-003A
VFC-100LB	10	2,948	50	VFC-100LB-005N ¹	VFN-100LB-005N ¹	VFC-100LB-005A ¹	VFN-100LB-005A ¹

1. Valve assemblies have two actuators mounted in tandem.

Two-Way, Spring-Return, Low-Pressure D-3000 Series Pneumatically Actuated, Standard-Pressure, Standard-Temperature Butterfly Valve Assemblies (Continued)

Technical Specifications

Two-Way, Spring-Return, Low-Pressure D-3000 Series Pneumatically Actuated, Standard-Pressure, Standard-Temperature Butterfly Valve Assemblies ¹		
Service	Hot, Chilled, or Condenser Water, and 50/50 Glycol Solutions (Not Designed for Use in Steam Applications)	
Body Styles and Sizes	Two-Way, 2 in. through 10 in., Fully Lugged	
Fluid Temperature Limits	-20°F to 250°F (-29°C or 121°C)	
Body Pressure Rating	175 psig	
Maximum Fluid Velocity	30 ft/second (9 m/second)	
Rangeability	Refer to the <i>VF Series Standard-Pressure, Standard-Temperature Butterfly Valves Product Bulletin (LIT-977205P)</i> .	
Leakage	Bubble Tight	
Flow Characteristics	Modified Equal Percentage	
Materials	Body	Cast Iron, ASTM A126 Class B
	Tee (Three-Way Valves Only)	Cast Iron
	Disc	Ductile Iron, Nylon 11 Coated, ASTM A536 Gr 65-45-12
	Seat	Ethylene Propylene Diene Monomer (EPDM)
	Stem	416 Stainless Steel
Ambient Temperature Limits	Storage	-20°F to 150°F (-29°C to 66°C), Preferably 40°F to 85°F (4°C to 29°C)
	Operating	Spring-Return Actuator: -20°F to 131°F (-29°C to 55°C) Non-Spring-Return Actuator: -4°F to 122°F (-20°C to 50°C)

1. Refer to the *VF Series Standard-Pressure, Standard-Temperature Butterfly Valves Product Bulletin (LIT-977205P)* for actuator specifications.

Two-Way, Industrial-Grade, Spring-Return, V-919x Series High-Pressure Pneumatically Actuated, Standard-Pressure, Standard-Temperature Butterfly Valve Assemblies

Description

VF Series Two-Way, Industrial-Grade, Spring-Return, V-919x Series High-Pressure Pneumatically Actuated, Standard-Pressure, Standard-Temperature Butterfly Valves are specifically designed for a wide range of HVAC applications, including two-position and modulating control of hot, chilled, or condenser water, and 50/50 glycol solutions. These valves are also bidirectional, allowing positive shutoff with the flow in either direction.

Refer to the *VF Series Standard-Pressure, Standard-Temperature Butterfly Valves Product Bulletin (LIT-977205P)* for important product application information.

Features

- low seating/unseating torques
- bubble-tight shutoff
- broad range of pre-assembled actuators

- compatible with all types of American National Standards Institute (ANSI) 125/150 slip-on and weld-neck flanges
- high-integrity components
- valve assemblies for on/off applications come standard with a 24 VAC or 120 VAC solenoid valve with speed controls
- valve assemblies for proportional applications come standard with a valve actuator positioner

Repair Information

If the VF Series Butterfly Valve Assembly fails to operate within its specifications, refer to the *VF Series Standard-Pressure, Standard-Temperature Butterfly Valves Product Bulletin (LIT-977205P)* for a list of repair parts available.

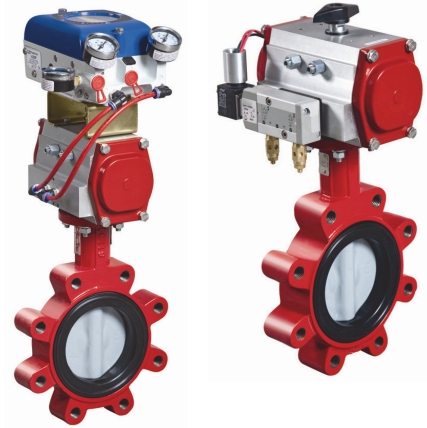

Two-Way, Industrial-Grade, Spring-Return, V-919x Series High-Pressure Pneumatically Actuated, Standard-Pressure, Standard-Temperature Butterfly Valve Assemblies

Selection Chart

Valve Code Number	Actuator				On/Off ¹		Proportional (with Positioner)	
	Size, in.	Cv at 90°	Cv at 60°	Closeoff Pressure, psig	Spring Closed	Spring Open	Spring Closed	Spring Open
Two-Way, Spring Return¹ — 150 or 175 psig Closeoff Pressure; 75 psig Dead-End Service								
VFC-020HB	2	144	61	175	VFC-020HB-320C	VFN-020HB-320C	VFC-020HB-320B	VFN-020HB-320B
VFC-025HB	2-1/2	282	107	175	VFC-025HB-330C	VFN-025HB-320C	VFC-025HB-330B	VFN-025HB-320B
VFC-030HB	3	461	154	175	VFC-030HB-340C	VFN-030HB-330C	VFC-030HB-340B	VFN-030HB-330B
VFC-040HB	4	841	274	175	VFC-040HB-450C	VFN-040HB-440C	VFC-040HB-450B	VFN-040HB-440B
VFC-050HB	5	1,376	428	175	VFC-050HB-432C	VFN-050HB-422C	VFC-050HB-432B	VFN-050HB-422B
VFC-060HB	6	1,850	567	175	VFC-060HB-442C	VFN-060HB-432C	VFC-060HB-442B	VFN-060HB-432B
VFC-080HB	8	3,316	1,081	175	VFC-080HB-640C	VFN-080HB-620C	VFC-080HB-640B	VFN-080HB-620B
VFC-100HB	10	5,430	1,710	175	VFC-100HB-740C	VFN-100HB-720C	VFC-100HB-740B	VFN-100HB-720B
VFC-120HB	12	8,077	2,563	175	VFC-120HB-750C	VFN-120HB-730C	VFC-120HB-750B	VFN-120HB-730B
VFC-140HC	14	10,538	3,384	150	VFC-140HC-760C	VFN-140HC-820C	VFC-140HC-760B	VFN-140HC-820B
VFC-160HC	16	13,966	4,483	150	VFC-160HC-840C	VFN-160HC-830C	VFC-160HC-840B	VFN-160HC-830B
VFC-180HC	18	17,214	5,736	150	VFC-180HC-850C	VFN-180HC-830C	VFC-180HC-850B	VFN-180HC-830B
VFC-200HC	20	22,339	7,144	150	VFC-200HC-860C	VFN-200HC-840C	VFC-200HC-860B	VFN-200HC-840B
Two-Way, Spring Return¹ — 50 psig Closeoff Pressure; Not Rated for Dead-End Service								
VFC-040LB	4	841	274	50	VFC-040LB-340C	VFN-040LB-330C	VFC-040LB-340B	VFN-040LB-330B
VFC-050LB	5	1,376	428	50	VFC-050LB-440C	VFN-050LB-340C	VFC-050LB-440B	VFN-050LB-340B
VFC-060LB	6	1,850	567	50	VFC-060LB-432C	VFN-060LB-422C	VFC-060LB-432B	VFN-060LB-422B
VFC-080LB	8	3,316	1,081	50	VFC-080LB-442C	VFN-080LB-432C	VFC-080LB-442B	VFN-080LB-432B
VFC-100LB	10	5,430	1,710	50	VFC-100LB-550C	VFN-100LB-530C	VFC-100LB-550B	VFN-100LB-530B
VFC-120LB	12	8,077	2,563	50	VFC-120LB-660C	VFN-120LB-630C	VFC-120LB-660B	VFN-120LB-630B
VFC-140LC	14	10,538	3,384	50	VFC-140LC-740C	VFN-140LC-720C	VFC-140LC-740B	VFN-140LC-720B
VFC-160LC	16	13,966	4,438	50	VFC-160LC-740C	VFN-160LC-730C	VFC-160LC-740B	VFN-160LC-730B
VFC-180LC	18	17,214	5,736	50	VFC-180LC-750C	VFN-180LC-730C	VFC-180LC-750B	VFN-180LC-730B
VFC-200LC	20	22,339	7,144	50	VFC-200LC-830C	VFN-200LC-820C	VFC-200LC-830B	VFN-200LC-820B

1. On/off assemblies come with a 120 VAC solenoid valve and speed controls. If a 24 VAC solenoid valve is desired, change the C at the end of the code number to an E.

Two-Way, Industrial-Grade, Spring-Return, V-919x Series High-Pressure Pneumatically Actuated, Standard-Pressure, Standard-Temperature Butterfly Valve Assemblies (Continued)

Technical Specifications

Two-Way, Industrial-Grade, Spring-Return, V-919x Series High-Pressure Pneumatically Actuated, Standard-Pressure, Standard-Temperature Butterfly Valve Assemblies ¹		
Service	Hot, Chilled, or Condenser Water, and 50/50 Glycol Solutions (Not Designed for Use in Steam Applications)	
Body Styles and Sizes	Two-Way, 2 in. through 20 in., Fully Lugged	
Fluid Temperature Limits	-20°F to 250°F (-29°C to 121°C)	
Body Pressure Rating	175 psig	
Maximum Fluid Velocity	30 ft/second (9 m/second)	
Rangeability	Refer to the <i>VF Series Standard-Pressure, Standard-Temperature Butterfly Valves Product Bulletin (LIT-977205P)</i> .	
Leakage	Bubble Tight	
Flow Characteristics	Modified Equal Percentage	
Materials	Body	Cast Iron, ASTM A126 Class B
	Tee (Three-Way Valves Only)	Cast Iron
	Disc	Ductile Iron, Nylon 11 Coated, ASTM A536 Gr 65-45-12
	Seat	Ethylene Propylene Diene Monomer (EPDM)
	Stem	416 Stainless Steel (2 in. through 12 in.) 304 Stainless Steel (14 in. through 20 in.)
Ambient Temperature Limits	Storage	-20°F to 150°F (-29°C to 66°C), Preferably 40°F to 85°F (4°C to 29°C)
	Operating	-20°F to 200°F (-29°C to 95°C)

1. Refer to the *VF Series Standard-Pressure, Standard-Temperature Butterfly Valves Product Bulletin (LIT-977205P)* for actuator specifications.

Two-Way, Industrial-Grade, Non-Spring-Return, V-909x Series High-Pressure Pneumatically Actuated, Standard-Pressure, Standard-Temperature Butterfly Valve Assemblies

Description

VF Series Two-Way, Industrial-Grade, Non-Spring-Return, V-909x Series High-Pressure Pneumatically Actuated, Standard-Pressure, Standard-Temperature Butterfly Valves are specifically designed for a wide range of HVAC applications, including two-position and modulating control of hot, chilled, or condenser water, and 50/50 glycol solutions. All valves are factory tested for bubble-tight shutoff at 100% of the fully rated pressure. These valves are also bidirectional, allowing positive shutoff with the flow in either direction.

Refer to the *VF Series Standard-Pressure, Standard-Temperature Butterfly Valves Product Bulletin (LIT-977205P)* for important product application information.

Features

- low seating/unseating torques
- bubble-tight shutoff
- broad range of pre-assembled actuators

- compatible with all types of American National Standards Institute (ANSI) 125/150 slip-on and weld-neck flanges
- high-integrity components
- air supply pressure of 70 psig to 90 psig (80 psig nominal; 140 psig maximum)
- valve assemblies for on/off applications come standard with a 24 VAC or 120 VAC solenoid valve with speed controls
- valve assemblies for proportional applications come standard with a valve actuator positioner

Repair Information

If the VF Series Butterfly Valve Assembly fails to operate within its specifications, refer to the *VF Series Standard-Pressure, Standard-Temperature Butterfly Valves Product Bulletin (LIT-977205P)* for a list of repair parts available.

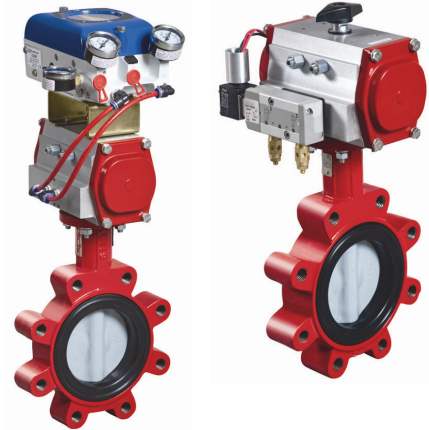

Two-Way, Industrial-Grade, Non-Spring-Return, V-909x Series High-Pressure Pneumatically Actuated, Standard-Pressure, Standard-Temperature Butterfly Valve Assemblies

Selection Chart

Valve Code Number	Actuator				On/Off ¹	Proportional (with Positioner)
	Size, in.	Cv at 90°	Cv at 70°	Closeoff Pressure, psig		
Two-Way, Non-Spring Return — 150 or 175 psig Closeoff Pressure; 75 psig Dead-End Service						
VFC-020HB	2	144	84	175	VFC-020HB-020C	VFC-020HB-020B
VFC-025HB	2-1/2	282	163	175	VFC-025HB-020C	VFC-025HB-020B
VFC-030HB	3	461	267	175	VFC-030HB-020C	VFC-030HB-020B
VFC-040HB	4	841	496	175	VFC-040HB-030C	VFC-040HB-030B
VFC-050HB	5	1,376	775	175	VFC-050HB-030C	VFC-050HB-030B
VFC-060HB	6	1,850	1,025	175	VFC-060HB-030C	VFC-060HB-030B
VFC-080HB	8	3,316	1,862	175	VFC-080HB-042C	VFC-080HB-042B
VFC-100HB	10	5,430	2,948	175	VFC-100HB-060C	VFC-100HB-060B
VFC-120HB	12	8,077	4,393	175	VFC-120HB-060C	VFC-120HB-060B
VFC-140HC	14	10,538	5,939	150	VFC-140HC-060C	VFC-140HC-060B
VFC-160HC	16	13,966	7,867	150	VFC-160HC-070C	VFC-160HC-070B
VFC-180HC	18	17,214	10,065	150	VFC-180HC-070C	VFC-180HC-070B
VFC-200HC	20	22,339	12,535	150	VFC-200HC-080C	VFC-200HC-080B
Two-Way, Non-Spring Return — 50 psig Closeoff, Not Rated for Dead-End Service						
VFC-040LB	4	841	496	50	VFC-040LB-030C	VFC-040LB-030B
VFC-050LB	5	1,376	775	50	VFC-050LB-030C	VFC-050LB-030B
VFC-060LB	6	1,850	1,025	50	VFC-060LB-030C	VFC-060LB-030B
VFC-080LB	8	3,316	1,862	50	VFC-080LB-042C	VFC-080LB-042B
VFC-100LB	10	5,430	2,948	50	VFC-100LB-042C	VFC-100LB-042B
VFC-120LB	12	8,077	4,393	50	VFC-120LB-042C	VFC-120LB-042B
VFC-140LC	14	10,538	5,939	50	VFC-140LC-060C	VFC-140LC-060B
VFC-160LC	16	13,966	7,867	50	VFC-160LC-060C	VFC-160LC-060B
VFC-180LC	18	17,214	10,065	50	VFC-180LC-070C	VFC-180LC-080B
VFC-200LC	20	22,339	12,535	50	VFC-200LC-070C	VFC-200LC-070B

1. On/off assemblies come with a 120 VAC solenoid valve and speed controls. If a 24 VAC solenoid valve is desired, change the C at the end of the code number to an E.

Two-Way, Industrial-Grade, Non-Spring-Return, V-909x Series High-Pressure Pneumatically Actuated, Standard-Pressure, Standard-Temperature Butterfly Valve Assemblies (Continued)

Technical Specifications

Two-Way, Industrial-Grade, Non-Spring-Return, V-909x Series High-Pressure Pneumatically Actuated, Standard-Pressure, Standard-Temperature Butterfly Valve Assemblies ¹		
Service		Hot, Chilled, or Condenser Water, and 50/50 Glycol Solutions (Not Designed for Use in Steam Applications)
Body Styles and Sizes		Two-Way, 2 in. through 20 in., Fully Lugged
Fluid Temperature Limits		-20°F to 250°F (-29°C to 121°C)
Body Pressure Rating		175 psig
Maximum Fluid Velocity		30 ft/second (9 m/second)
Rangeability		Refer to the <i>VF Series Standard-Pressure, Standard-Temperature Butterfly Valves Product Bulletin (LIT-977205P)</i> .
Leakage		Bubble Tight
Flow Characteristics		Modified Equal Percentage
Materials	Body	Cast Iron, ASTM A126 Class B
	Tee (Three-Way Valves Only)	Cast Iron
	Disc	Ductile Iron, Nylon 11 Coated, ASTM A536 Gr 65-45-12
	Seat	Ethylene Propylene Diene Monomer (EPDM)
	Stem	416 Stainless Steel (2 in. through 12 in.) 304 Stainless Steel (14 in. through 20 in.)
Ambient Temperature Limits	Storage	-20°F to 150°F (-29°C to 66°C), Preferably 40°F to 85°F (4°C to 29°C)
	Operating	-20°F to 200°F (-29°C to 95°C)

1. Refer to the *VF Series Standard-Pressure, Standard-Temperature Butterfly Valves Product Bulletin (LIT-977205P)* for actuator specifications.

Two-Way, Industrial-Grade, Manually Operated, Standard-Pressure, Standard-Temperature Butterfly Valve Assemblies

Description

VF Series Two-Way, Industrial-Grade, Manually Operated, Standard-Pressure, Standard-Temperature Butterfly Valves are specifically designed for a wide range of HVAC applications, including two-position and modulating control of hot, chilled, or condenser water, and 50/50 glycol solutions. All valves are factory tested for bubble-tight shutoff at 100% of the fully rated pressure. These valves are bidirectional, allowing positive shutoff with the flow in either direction.

Refer to the *VF Series Standard-Pressure, Standard-Temperature Butterfly Valves Product Bulletin (LIT-977205P)* for important product application information.

Features

- low seating/unseating torques
- bubble-tight shutoff
- broad range of pre-assembled actuators
- compatible with all types of American National Standards Institute (ANSI) 125/150 slip-on and weld-neck flanges
- high-integrity components
- manually operated



Two-Way, Industrial-Grade, Manually Operated, Standard-Pressure, Standard-Temperature Butterfly Valve Assemblies

Repair Information

If the VF Series Butterfly Valve Assembly fails to operate within its specifications, refer to the *VF Series Standard-Pressure, Standard-Temperature Butterfly Valves Product Bulletin (LIT-977205P)* for a list of repair parts available.

Selection Chart

Valve Code Number	Actuator			Ten-Position Manual Handle	Gear-Operated Manual Hand Wheel
	Size, in.	Cv at 90°	Closeoff Pressure, psig		
Two-Way, Manually Operated — 150 or 175 psig Closeoff Pressure; 75 psig Dead-End Service					
VFM-020HB	2	144	175	VFM-020HB-000M	VFM-020HB-000G
VFM-025HB	2-1/2	282	175	VFM-025HB-000M	VFM-025HB-000G
VFM-030HB	3	461	175	VFM-030HB-000M	VFM-030HB-000G
VFM-040HB	4	841	175	VFM-040HB-000M	VFM-040HB-000G
VFM-050HB	5	1,376	175	VFM-050HB-000M	VFM-050HB-000G
VFM-060HB	6	1,850	175	VFM-060HB-000M	VFM-060HB-000G
VFM-080HB	8	3,316	175		VFM-080HB-000G
VFM-100HB	10	5,430	175		VFM-100HB-000G
VFM-120HB	12	8,077	175		VFM-120HB-000G
VFM-140HC	14	10,538	150		VFM-140HC-000G
VFM-160HC	16	13,966	150		VFM-160HC-000G
VFM-180HC	18	17,214	150		VFM-180HC-000G
VFM-200HC	20	22,339	150		VFM-200HC-000G

Two-Way, Industrial-Grade, Manually Operated, Standard-Pressure, Standard-Temperature Butterfly Valve Assemblies (Continued)

Technical Specifications

Two-Way, Industrial-Grade, Manually Operated, Standard-Pressure, Standard-Temperature Butterfly Valve Assemblies¹		
Service	Hot, Chilled, or Condenser Water, and 50/50 Glycol Solutions (Not Designed for Use in Steam Applications)	
Body Styles and Sizes	Two-Way, 2 in. through 20 in., Fully Lugged	
Fluid Temperature Limits	-20°F to 250°F (-29°C to 121°C)	
Body Pressure Rating	175 psig	
Maximum Fluid Velocity	30 ft/second (9 m/second)	
Rangeability	Refer to the <i>VF Series Standard-Pressure, Standard-Temperature Butterfly Valves Product Bulletin (LIT-977205P)</i> .	
Leakage	Bubble Tight	
Flow Characteristics	Modified Equal Percentage	
Materials	Body	Cast Iron, ASTM A126 Class B
	Tee (Three-Way Valves Only)	Cast Iron
	Disc	Ductile Iron, Nylon 11 Coated, ASTM A536 Gr 65-45-12
	Seat	Ethylene Propylene Diene Monomer (EPDM)
	Stem	416 Stainless Steel (2 in. through 12 in.) 304 Stainless Steel (14 in. through 20 in.)
Ambient Temperature Limits	Storage	-20°F to 150°F (-29°C to 66°C), Preferably 40°F to 85°F (4°C to 29°C)
	Operating	-20°F to 200°F (-29°C to 95°C)

1. Refer to the *VF Series Standard-Pressure, Standard-Temperature Butterfly Valves Product Bulletin (LIT-977205P)* for actuator specifications.

M9000 Series Electrically Actuated, Standard-Pressure, Standard-Temperature, Three-Way Butterfly Valves (without Weather Shield)

Description

VF Series M9000 Electrically Actuated, Standard-Pressure, Standard-Temperature, Three-Way Butterfly Valves are specifically designed for a wide range of HVAC applications, including two-position and modulating control of hot, chilled, or condenser water, and 50/50 glycol solutions. These valves are also bidirectional, allowing positive shutoff with the flow in either direction.

Three-way configurations are available in sizes 2 through 6 in. non-spring return, and 2 through 4 in. spring return. M9000 electrically actuated, non-weather shield models feature an integral handle for manual positioning of the valve, independent of a power supply.

Refer to the *VF Series Standard-Pressure, Standard-Temperature Butterfly Valves Product Bulletin (LIT-977205P)* for important product application information.

Features

- low seating/unseating torques
- bubble-tight shutoff
- broad range of pre-assembled actuators
- compatible with all types of American National Standards Institute (ANSI) 125/150 slip-on and weld-neck flanges
- high-integrity components
- M9000 Series electric actuators available with or without a rugged, factory-installed weather shield
- M9000 Series electric actuators available with or without end switches

Repair Information

If the VF Series Butterfly Valve fails to operate within its specifications, refer to the *VF Series Standard-Pressure, Standard-Temperature Butterfly Valves Product Bulletin (LIT-977205P)* for a list of repair parts available.

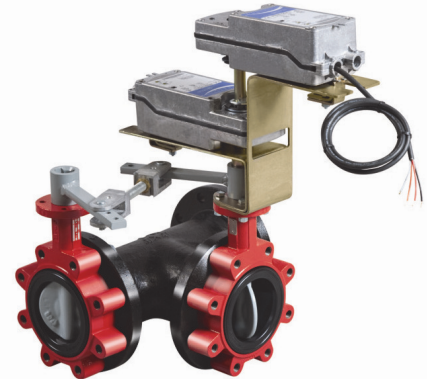

Three-Way Valve with M9000 Series Electric Actuator (without Weather Shield)

Selection Chart

Valve Code Number	Size, in.	Cv at 90°	Cv at 70°	Closeoff Pressure, psig ¹	Three-Way Butterfly Valves			
					Three-Way — Spring Return²			
					On/Off Control		Proportional Control	
					M9220-BGA-3 without End Switches	M9220-BGC-3 with Two End Switches	M9220-GGA-3 without End Switches	M9220-GGC-3 with Two End Switches
VFD020HB	2	144	84	175	VFD020HB+92NBGA	VFD020HB+92NBGC	VFD020HB+92NGGA	VFD020HB+92NGGC
VFD025HB	2-1/2	282	163	175	VFD025HB+92NBGA	VFD025HB+92NBGC	VFD025HB+92NGGA	VFD025HB+92NGGC
VFD030HB	3	461	267	175	VFD030HB292NBGA ³	VFD030HB292NBGC ³	VFD030HB292NGGA ³	VFD030HB292NGGC ³
VFD040LB	4	841	496	50	VFD040LB292NBGA ³	VFD040LB292NBGC ³	VFD040LB292NGGA ³	VFD040LB292NGGC ³
					Floating Control			
					M9220-AGA-3 without End Switches	M9220-AGC-3 with Two End Switches		
VFD020HB	2	144	84	175	VFD020HB+92NAGA	VFD020HB+92NAGC		
VFD025HB	2-1/2	282	163	175	VFD025HB+92NAGA	VFD025HB+92NAGC		
VFD030HB	3	461	267	175	VFD030HB292NAGA ³	VFD030HB292NAGC ³		
VFD040LB	4	841	496	50	VFD040LB292NAGA ³	VFD040LB292NAGC ³		
					Three-Way — Non-Spring Return			
					On/Off (Floating) Control		0 to 10 VDC Proportional Control	
					M91xx-AGA-2 without End Switches	M91xx-AGC-2 with Two End Switches	M91xx-GGA-2 without End Switches	M91xx-GGC-2 with Two End Switches
VFD020HB	2	144	84	175	VFD020HB+916AGA	VFD020HB+916AGC	VFD020HB+916GGA	VFD020HB+916GGC
VFD025HB	2-1/2	282	163	175	VFD025HB+916AGA	VFD025HB+916AGC	VFD025HB+916GGA	VFD025HB+916GGC
VFD030HB	3	461	267	175	VFD030HB+924AGA	VFD030HB+924AGC	VFD030HB+924GGA	VFD030HB+924GGC
VFD040LB	4	841	496	50	VFD040LB+924AGA	VFD040LB+924AGC	VFD040LB+924GGA	VFD040LB+924GGC
VFD040HB	4	841	496	175	VFD040HB2924AGA ³	VFD040HB2924AGC ³	VFD040HB2924GGA ³	VFD040HB2924GGC ³
VFD050LB	5	1376	775	50	VFD050LB2924AGA ³	VFD050LB2924AGC ³	VFD050LB2924GGA ³	VFD050LB2924GGC ³
VFD060LB	6	1850	1025	50	VFD060LB2924AGA ³	VFD060LB2924AGC ³	VFD060LB2924GGA ³	VFD060LB2924GGC ³

The performance specifications are nominal and conform to acceptable industry standards. For applications at conditions beyond these specifications, consult the local Johnson Controls office. Johnson Controls shall not be liable for damages resulting from misapplication or misuse of its products. © 2019 Johnson Controls. www.johnsoncontrols.com

M9000 Series Electrically Actuated, Standard-Pressure, Standard-Temperature, Three-Way Butterfly Valves (without Weather Shield) (Continued)

Valve Code Number	Size, in.	Cv at 90°	Cv at 70°	Closeoff Pressure, psig ¹	Three-Way Butterfly Valves	
					Three-Way — Non-Spring Return	
					Automatic Signal Detection Floating, On/Off, Proportional	
					M93xx-HGC-2 Without End Switches	M93xx-HGC-2 With Two End Switches
VFD020HB	2	144	84	175	VFD020HB+920HGA	VFD020HB+920HGC
VFD025HB	2-1/2	282	163	175	VFD025HB+920HGA	VFD025HB+920HGC
VFD030HB	3	461	267	175	VFD030HB+935HGA	VFD030HB+935HGC
VFD040HB	4	841	496	175	VFD040HB2935HGA ³	VFD040HB2935HGC ³
VFD040LB	4	841	496	50	VFD040LB+935HGA	VFD040LB+935HGC
VFD050HB	5	1376	775	175	VFD050HB2935HGA ³	VFD050HB2935HGC ³
VFD050LB	5	1376	775	50	VFD050LB2935HGA ³	VFD050LB2935HGC ³
VFD060HB	6	1850	1025	175	VFD060HB2935HGA ³	VFD060HB2935HGC ³
VFD060NB	6	1850	1025	50	VFD060NB2935HGA ³	VFD060NB2935HGC ³

- Valves rated for 175 psig closeoff have a 75 psig maximum dead-end service rating. Valves rated for 50 psig closeoff are not rated for dead-end service.
- Code numbers listed in this table are three-way valves, style D. For styles E, F, or G, change the D in the third digit of the code number to the desired style.
Example: VFExxxxx+xxxxx, VFFxxxxx+xxxxx, or VFGxxxxx+xxxxx. See the following figure.
- Valve assemblies have two actuators mounted in tandem.

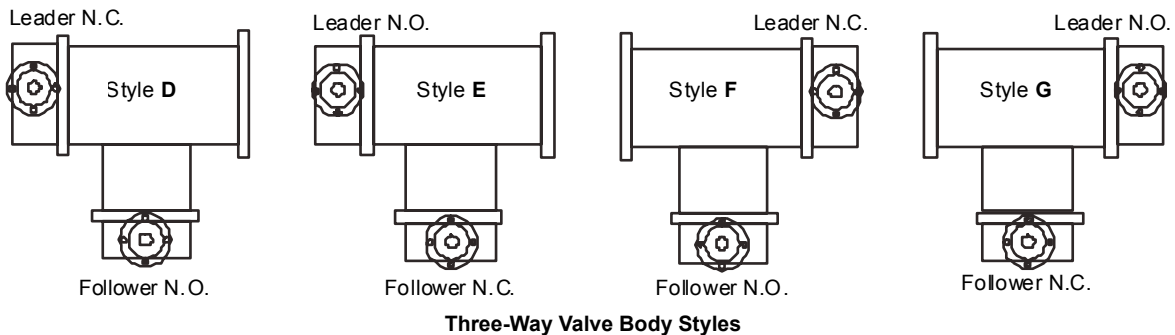

Technical Specifications

M9000 Series Electrically Actuated, Standard-Pressure, Standard-Temperature, Three-Way Butterfly Valves (without Weather Shield) ¹		
Service	Hot, Chilled, or Condenser Water, and 50/50Glycol Solutions (Not Designed for Use in Steam Applications)	
Body Styles and Sizes	Three-Way, 2 through 6 in., Fully Lugged	
Fluid Temperature Limits	-20°F to 250°F (-29°C to 121°C)	
Body Pressure Rating	175 psig	
Maximum Fluid Velocity	30 ft/second (9 m/second)	
Rangeability	Refer to the <i>VF Series Standard-Pressure, Standard-Temperature Butterfly Valves Product Bulletin (LIT-977205P)</i> .	
Leakage	Bubble Tight	
Flow Characteristics	Modified Equal Percentage	
Materials	Body	Cast Iron, ASTM A126 Class B
	Tee (Three-Way Valves Only)	Cast Iron
	Disc	Ductile Iron, Nylon 11 Coated, ASTM A536 Gr 65-45-12
	Seat	Ethylene Propylene Diene Monomer (EPDM)
	Stem	416 Stainless Steel
Ambient Temperature Limits	Storage	-20°F to 150°F (-29°C to 66°C), Preferably 40°F to 85°F (4°C to 29°C)
	Operating	Spring-Return Actuator: -20°F to 131°F (-29°C to 55°C) Non-Spring-Return Actuator: -4°F to 122°F (-20°C to 50°C)

1. Refer to the *VF Series Standard-Pressure, Standard-Temperature Butterfly Valves Product Bulletin (LIT-977205P)* for actuator specifications.

M9000 Series Electrically Actuated, Standard-Pressure, Standard-Temperature, Three-Way Butterfly Valves (with Weather Shield)

Description

VF Series M9000 Electrically Actuated, Standard-Pressure, Standard-Temperature, Three-Way Butterfly Valves are specifically designed for a wide range of HVAC applications, including two-position and modulating control of hot, chilled, or condenser water, and 50/50 glycol solutions. These valves are also bidirectional, allowing positive shutoff with the flow in either direction.

Three-way configurations are available in sizes 2 through 6 in. non-spring return, and 2 through 4 in. spring return. M9000 electrically actuated spring-return, weather-shield models feature an integral handle for manual positioning of the valve, independent of a power supply.

Refer to the *VF Series Standard-Pressure, Standard-Temperature Butterfly Valves Product Bulletin (LIT-977205P)* for important product application information.

Features

- low seating/unseating torques
- bubble-tight shutoff
- broad range of pre-assembled actuators
- compatible with all types of American National Standards Institute (ANSI) 125/150 slip-on and weld-neck flanges
- high-integrity components
- M9000 electric actuators available with or without a rugged, factory-installed weather shield
- M9000 electric actuators available with or without end switches

Repair Information

If the VF Series Butterfly Valve fails to operate within its specifications, refer to the *VF Series Standard-Pressure, Standard-Temperature Butterfly Valves Product Bulletin (LIT-977205P)* for a list of repair parts available.



M9000 Series Electrically Actuated, Standard-Pressure, Standard-Temperature, Three-Way Butterfly Valves (with Weather Shield)

Selection Chart

Valve Code Number	Size, in.	Cv at 90°	Cv at 70°	Closeoff Pressure, psig ¹	M9000 Series Electrically Actuated Standard-Pressure, Standard-Temperature, Three-Way Butterfly Valves (with Weather Shield)			
					Three-Way — Spring Return²			
					On/Off Control		Proportional Control	
					M9220-BGA-3 without End Switches	M9220-BGC-3 with Two End Switches	M9220-GGA-3 without End Switches	M9220-GGC-3 with Two End Switches
VWD020HB	2	144	84	175	VWD020HB+92NBGA	VWD020HB+92NBGC	VWD020HB+92NGGA	VWD020HB+92NGGC
VWD025HB	2-1/2	282	163	175	VWD025HB+92NBGA	VWD025HB+92NBGC	VWD025HB+92NGGA	VWD025HB+92NGGC
VWD030HB	3	461	267	175	VWD030HB292NBGA ³	VWD030HB292NBGC ³	VWD030HB292NGGA ³	VWD030HB292NGGC ³
VWD040LB	4	841	496	50	VWD040LB292NBGA ³	VWD040LB292NBGC ³	VWD040LB292NGGA ³	VWD040LB292NGGC ³
					Floating Control			
					M9220-AGA-3 without End Switches		M9220-AGC-3 with Two End Switches	
VWD020HB	2	144	84	175	VWD020HB+92NAGA	VWD020HB+92NAGC		
VWD025HB	2-1/2	282	163	175	VWD025HB+92NAGA	VWD025HB+92NAGC		
VWD030HB	3	461	267	175	VWD030HB292NAGA ³	VWD030HB292NAGC ³		
VWD040LB	4	841	496	50	VWD040LB292NAGA ³	VWD040LB292NAGC ³		

The performance specifications are nominal and conform to acceptable industry standards. For applications at conditions beyond these specifications, consult the local Johnson Controls office. Johnson Controls shall not be liable for damages resulting from misapplication or misuse of its products. © 2019 Johnson Controls. www.johnsoncontrols.com

M9000 Series Electrically Actuated, Standard-Pressure, Standard-Temperature, Three-Way Butterfly Valves (with Weather Shield) (Continued)

Valve Code Number	Size, in.	Cv at 90°	Cv at 70°	Closeoff Pressure, psig ¹	M9000 Series Electrically Actuated Standard-Pressure, Standard-Temperature, Three-Way Butterfly Valves (with Weather Shield)	
					Two-Way — Non-Spring Return	
					Automatic Signal Detection Floating, On/Off, Proportional	
					M93xx-HGC-2 Without End Switches	M93xx-HGC-2 With Two End Switches
VWD020HB	2	144	84	175	VWD020HB+920HGA	VWD020HB+920HGA
VWD020HB	2	144	84	175	VWD020HB+920HGC	VWD020HB+920HGC
VWD025HB	2-1/2	282	163	175	VWD025HB+920HGA	VWD025HB+920HGA
VWD025HB	2-1/2	282	163	175	VWD025HB+920HGC	VWD025HB+920HGC
VWD030HB	3	461	267	175	VWD030HB+935HGA	VWD030HB+935HGA
VWD030HB	3	461	267	175	VWD030HB+935HGC	VWD030HB+935HGC
VWD040HB	4	841	496	175	VWD040HB2935HGA ³	VWD040HB2935HGA ³
VWD040HB	4	841	496	175	VWD040HB2935HGC ³	VWD040HB2935HGC ³
VWD040LB	4	841	496	50	VWD040LB+920HGA	VWD040LB+920HGA
VWD040LB	4	841	496	50	VWD040LB+920HGC	VWD040LB+920HGC
VWD050HB	5	1376	775	175	VWD050HB2935HGA ³	VWD050HB2935HGA ³
VWD050HB	5	1376	775	175	VWD050HB2935HGC ³	VWD050HB2935HGC ³
VWD050LB	5	1376	775	50	VWD050LB2935HGA	VWD050LB2935HGA
VWD050LB	5	1376	775	50	VWD050LB2935HGC	VWD050LB2935HGC
VWD060HB	6	1850	1025	175	VWD060HB2935HGA ³	VWD060HB2935HGA ³
VWD060HB	6	1850	1025	175	VWD060HB2935HGC ³	VWD060HB2935HGC ³
VWD060NB	6	1850	1025	50	VWD060NB2935HGA ³	VWD060NB2935HGA ³
VWD060NB	6	1850	1025	50	VWD060NB2935HGC ³	VWD060NB2935HGC ³

- All valves are rated for dead-end service. Valves rated for 75 psig closeoff or higher have a 75 psig maximum dead-end service rating.
- Code numbers listed in this table are three-way valves, style D. For styles E, F, or G, change the D in the third digit of the code number to the desired style.
Example: VWExxxxx+xxxxxx, VWFxxxxx+xxxxxx, or VWGxxxxx+xxxxxx. See the following figure.
- Valve assemblies have two actuators mounted in tandem.

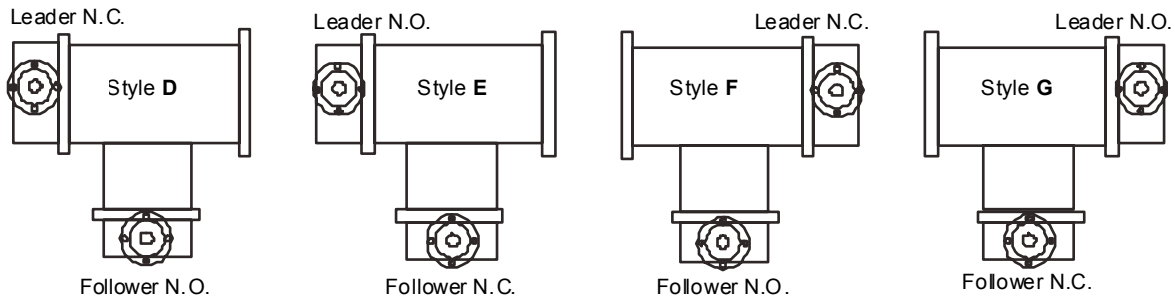

Three-Way Valve Body Styles

M9000 Series Electrically Actuated, Standard-Pressure, Standard-Temperature, Three-Way Butterfly Valves (with Weather Shield) (Continued)

Technical Specifications

M9000 Series Electrically Actuated, Standard-Pressure, Standard-Temperature, Three-Way Butterfly Valves (with Weather Shield)¹		
Service	Hot, Chilled, or Condenser Water, and 50/50 Glycol Solutions (Not Designed for Use in Steam Applications)	
Body Styles and Sizes	Three-Way, 2 through 6 in., Fully Lugged	
Fluid Temperature Limits	-20°F to 250°F (-29°C to 121°C)	
Body Pressure Rating	175 psig	
Maximum Fluid Velocity	30 ft/second (9 m/second)	
Rangeability	Refer to the <i>VF Series Standard-Pressure, Standard-Temperature Butterfly Valves Product Bulletin (LIT-977205P)</i> .	
Leakage	Bubble Tight	
Flow Characteristics	Modified Equal Percentage	
Materials	Body	Cast Iron, ASTM A126 Class B
	Tee (Three-Way Valves Only)	Cast Iron
	Disc	Ductile Iron, Nylon 11 Coated, ASTM A536 Gr 65-45-12
	Seat	Ethylene Propylene Diene Monomer (EPDM)
	Stem	416 Stainless Steel
Ambient Temperature Limits	Storage	-20°F to 150°F (-29°C to 66°C), Preferably 40°F to 85°F (4°C to 29°C)
	Operating	Spring-Return Actuator: -20°F to 131°F (-29°C to 55°C) Non-Spring-Return Actuator: -4°F to 122°F (-20°C to 50°C)
Weather Shield Rating	National Electrical Manufacturers' Association (NEMA) 4	

1. Refer to the *VF Series Standard-Pressure, Standard-Temperature Butterfly Valves Product Bulletin (LIT-977205P)* for actuator specifications.

VF Series Three-Way, Industrial-Grade, Non-Spring-Return, VA-907x Series Electric Actuated, Standard-Pressure, Standard-Temperature Butterfly Valve Assemblies

Description

VF Series Three-Way, Industrial-Grade, Non-Spring-Return, VA-907x Series Electric Actuated, Standard-Pressure, Standard-Temperature Butterfly Valves are specifically designed for a wide range of Heating, Ventilating, and Air Conditioning (HVAC) applications, including two-position and modulating control of hot, chilled, or condenser water, and 50/50 glycol solutions. All valves are factory tested for bubble-tight shutoff at 100% of the fully-rated pressure. These valves are bidirectional, allowing positive shutoff with the flow in either direction.

Refer to the *VF Series Standard-Pressure, Standard-Temperature Butterfly Valves Product Bulletin (LIT-977205P)* for important product application information.

Features

- low seating/unseating torques
- bubble-tight shutoff
- broad range of pre-assembled actuators

- compatible with all types of American National Standards Institute (ANSI) 125/150 slip-on and weld-neck flanges
- high-integrity components

Repair Information

If the Three-Way, Industrial-Grade, Non-Spring-Return, VA-907x Series Electric Actuated, Standard-Pressure, Standard-Temperature Butterfly Valve fails to operate within its specifications, refer to the *VF Series Standard-Pressure, Standard-Temperature Butterfly Valves Product Bulletin (LIT-977205P)* for a list of repair parts available.



Three-Way, Industrial-Grade, Non-Spring-Return, VA-907x Series Electric Actuated, Standard-Pressure, Standard-Temperature Butterfly Valves

Selection Chart

Actuator				AC 120 V Powered Actuator		AC 24 V Powered Actuator	
Size, in.	Cv at 90°	Cv at 60°	Closeoff Pressure psig	On/Off	0 VDC to 10 VDC Proportional	On/Off	0 VDC to 10 VDC Proportional
Three-Way, Non-Spring Return¹ – 150 or 175 psig Closeoff Pressure; 75 psig Dead-End Service							
2	144	61	175	VFD-020HB-722D	VFD-020HB-702N	VFD-020HB-722D4	VFD-020HB-702N4
2-1/2	282	107	175	VFD-025HB-722D	VFD-025HB-702N	VFD-025HB-722D4	VFD-025HB-702N4
3	461	154	175	VFD-030HB-722D	VFD-030HB-702N	VFD-030HB-722D4	VFD-030HB-702N4
4	841	274	175	VFD-040HB-722D	VFD-040HB-702N	VFD-040HB-722D4	VFD-040HB-702N4
5	1,376	428	175	VFD-050HB-722D	VFD-050HB-702N	VFD-050HB-722D4	VFD-050HB-702N4
6	1,850	567	175	VFD-060HB-724D	VFD-060HB-704N	VFD-060HB-725D4	VFD-060HB-705N4
8	3,316	1,081	175	VFD-080HB-725D	VFD-080HB-705N	VFD-080HB-725D4	VFD-080HB-705N4
10	5,430	1,710	175	VFD-100HB-727D	VFD-100HB-707N	VFD-100HB-727D4	VFD-100HB-707N4
12	8,077	2,563	175	VFD-120HB-727D	VFD-120HB-707N	—	—
Three-Way, Non-Spring Return¹ – 50 psig Closeoff Pressure; Not Rated for Dead-End Service							
4	841	274	50	VFD-040LB-722D	VFD-040LB-702N	VFD-040LB-722D4	VFD-040LB-702N4
5	1,376	428	50	VFD-050LB-722D	VFD-050LB-702N	VFD-050LB-722D4	VFD-050LB-702N4
6	1,850	567	50	VFD-060LB-722D	VFD-060LB-702N	VFD-060LB-722D4	VFD-060LB-702N4
8	3,316	1,081	50	VFD-080LB-724D	VFD-080LB-704N	VFD-080LB-725D4	VFD-080LB-705N4
10	5,430	1,710	50	VFD-100LB-725D	VFD-100LB-705N	VFD-100LB-725D4	VFD-100LB-705N4
12	8,077	2,563	50	VFD-120LB-726D	VFD-120LB-706N	VFD-120LB-727D4	VFD-120LB-707N4

1. Code numbers listed are three-way valves, style **D**. For styles **E**, **F**, or **G**, change the **D** in the third digit of the code number to the desired style. Example: VFE-xxxxx-xxxx, VFF-xxxxx-xxxx, or VFG-xxxxx-xxxx (see the following figure).

VF Series Three-Way, Industrial-Grade, Non-Spring-Return, VA-907x Series Electric Actuated, Standard-Pressure, Standard-Temperature Butterfly Valve Assemblies (Continued)

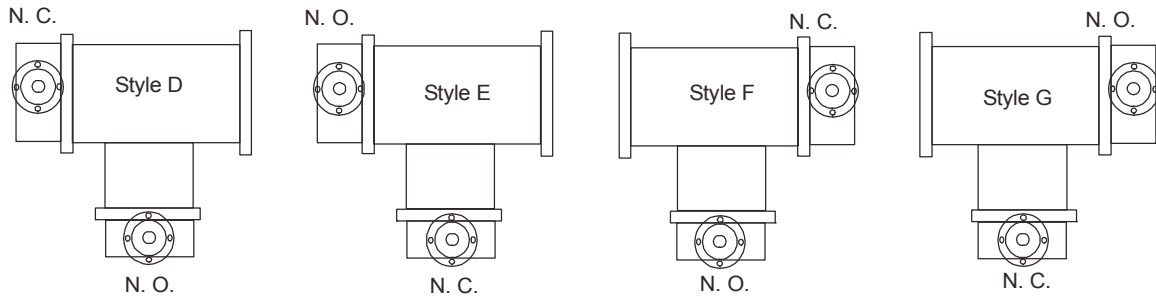

Three-Way Valve Body Styles

Technical Specifications

Three-Way, Industrial-Grade, Non-Spring-Return, VA-907x Series Electric Actuated, Standard-Pressure, Standard-Temperature Butterfly Valve Assemblies ¹		
Service	Hot, Chilled, or Condenser Water, and 50/50 Glycol Solutions (Not designed for use in steam applications.)	
Body Styles and Sizes	Three-Way, 2 in. through 12 in., Fully Lugged	
Fluid Temperature Limits	-20°F to 250°F (-29°C to 121°C)	
Body Pressure Rating	250 psig (1723 kPa)	
Maximum Fluid Velocity	30 ft/second (9 m/second)	
Rangeability	Refer to the <i>VF Series Standard-Pressure, Standard-Temperature Butterfly Valves Product Bulletin (LIT-977205P)</i> .	
Leakage	Bubble Tight	
Flow Characteristics	Modified Equal Percentage	
Materials	Body	Cast Iron, ASTM A126 Class B
	Tee (Three-Way Valves Only)	Cast Iron
	Disc	Ductile Iron, Nylon 11 Coated, ASTM A536 Gr 65-45-12
	Seat	Ethylene Propylene Diene Monomer (EPDM)
	Stem	416 Stainless Steel
Ambient Temperature Limits	Storage	-20°F to 150°F (-29°C to 66°C), Preferably 40°F to 85°F (4°C to 29°C)
	Operating	-20°F to 150°F (-29°C to 65°C)
Enclosure Rating	National Electrical Manufacturers' Association (NEMA) 4	

1. Refer to the *VF Series Standard-Pressure, Standard-Temperature Butterfly Valves Product Bulletin (LIT-977205P)* for actuator specifications.

Three-Way, Spring-Return, Low-Pressure D-3000 Series Pneumatically Actuated, Standard-Pressure, Standard-Temperature Butterfly Valve Assemblies

Description

VF Series Three-Way, Spring-Return, Low-Pressure D-3000 Series Pneumatically Actuated, Standard-Pressure, Standard-Temperature Butterfly Valves are specifically designed for a wide range of HVAC applications, including two-position and modulating control of hot, chilled, or condenser water, and 50/50 glycol solutions. These valves are also bidirectional, allowing positive shutoff with the flow in either direction. Three-way assemblies have two valves that are linked together and mounted on a flanged, cast-iron tee. Three-way configurations are available in sizes 2 in. through 8 in.

Refer to the *VF Series Standard-Pressure, Standard-Temperature Butterfly Valves Product Bulletin (LIT-977205P)* for important product application information.

Features

- low seating/unseating torques
- bubble-tight shutoff
- broad range of pre-assembled actuators

- compatible with all types of American National Standards Institute (ANSI) 125/150 slip-on and weld-neck flanges
- high-integrity components
- D-3000 Series pneumatic actuators available with or without a pneumatic positioner
- air supply pressure 20 psi minimum
- valve assemblies for on/off applications with valve actuator positioner, 30 psig maximum pressure rating
- valve assemblies for proportional applications standard with D-9502 valve actuator positioner, 25 psig maximum air pressure rating

Repair Information

If the VF Series Butterfly Valve Assembly fails to operate within its specifications, refer to the *VF Series Standard-Pressure, Standard-Temperature Butterfly Valves Product Bulletin (LIT-977205P)* for a list of repair parts available.



Three-Way, Spring-Return, Low-Pressure D-3000 Series Pneumatically Actuated, Standard-Pressure, Standard-Temperature Butterfly Valve Assembly

Selection Chart

Valve Code Number	Size, in.	Cv at 70°	Closeoff Pressure, psig	Actuator	
				On/Off Control	Proportional Control (with Positioner)
Three-Way Butterfly Valve Assemblies¹ — 175 psig Closeoff Pressure — Rated for 75 psig Dead-End Service					
VFD-020HB	2	84	175	VFD-020HB-001N	VFD-020HB-001A
VFD-025HB	2-1/2	163	175	VFD-025HB-002N	VFD-025HB-002A
VFD-030HB	3	267	175	VFD-030HB-002N	VFD-030HB-002A
VFD-040HB	4	496	175	VFD-040HB-003N	VFD-040HB-003A
VFD-050HB	5	775	175	VFD-050HB-003N	VFD-050HB-003A
VFD-060HB	6	1,025	175	VFD-060HB-005N ²	VFD-060HB-005A ²
Three-Way Butterfly Valve Assemblies¹ — 50 psig Closeoff Pressure — Not Rated for Dead-End Service					
VFD-040LB	4	496	50	VFD-040LB-002N	VFD-040LB-002A
VFD-050LB	5	775	50	VFD-050LB-003N	VFD-050LB-003A
VFD-060LB	6	1,025	50	VFD-060LB-003N	VFD-060LB-003A
VFD-080LB	8	1,862	50	VFD-080LB-005N ²	VFD-080LB-005A ²

1. Code numbers listed are three-way valves, style D. For styles E, F, or G, change the D in the third digit of the code number to the desired style. Example: VFE-xxxx-xxxx, VFF-xxxx-xxxx, or VFG-xxxx-xxxx. See the following figure.

2. Valve assemblies have two actuators mounted in tandem.

Three-Way, Spring-Return, Low-Pressure D-3000 Series Pneumatically Actuated, Standard-Pressure, Standard-Temperature Butterfly Valve Assemblies (Continued)

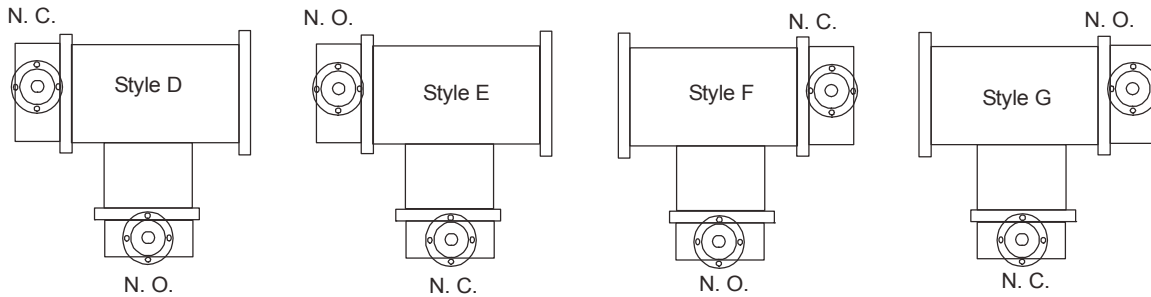

Three-Way Valve Body Styles

Technical Specifications

Three-Way, Spring-Return, Low-Pressure D-3000 Series Pneumatically Actuated, Standard-Pressure, Standard-Temperature Butterfly Valve Assemblies¹		
Service	Hot, Chilled, or Condenser Water, and 50/50 Glycol Solutions (Not Designed for Use in Steam Applications)	
Body Styles and Sizes	Three-Way, 2 in. through 8 in., Fully Lugged	
Fluid Temperature Limits	-20°F to 250°F (-29°C to 121°C)	
Body Pressure Rating	175 psig	
Maximum Fluid Velocity	30 ft/second (9 m/second)	
Rangeability	Refer to the <i>VF Series Standard-Pressure, Standard-Temperature Butterfly Valves Product Bulletin (LIT-977205P)</i> .	
Leakage	Bubble Tight	
Flow Characteristics	Modified Equal Percentage	
Materials	Body	Cast Iron, ASTM A126 Class B
	Tee (Three-Way Valves Only)	Cast Iron
	Disc	Ductile Iron, Nylon 11 Coated, ASTM A536 Gr 65-45-12
	Seat	Ethylene Propylene Diene Monomer (EPDM)
	Stem	416 Stainless Steel
Ambient Temperature Limits	Storage	-20°F to 150°F (-29°C to 66°C), Preferably 40°F to 85°F (4°C to 29°C)
	Operating	Spring-Return Actuator: -20°F to 131°F (-29°C to 55°C) Non-Spring-Return Actuator: -4°F to 122°F (-20°C to 50°C)

1. Refer to the *VF Series Standard-Pressure, Standard-Temperature Butterfly Valves Product Bulletin (LIT-977205P)* for actuator specifications.

Three-Way, Industrial-Grade, Spring-Return, V-919x Series High-Pressure Pneumatically Actuated, Standard-Pressure, Standard-Temperature Butterfly Valve Assemblies

Description

VF Series Three-Way, Industrial-Grade, Spring-Return, V-919x Series High-Pressure Pneumatically Actuated, Standard-Pressure, Standard-Temperature Butterfly Valves are specifically designed for a wide range of HVAC applications, including two-position and modulating control of hot, chilled, or condenser water, and 50/50 glycol solutions. All valves are factory tested for bubble-tight shutoff at 100% of the fully rated pressure. These valves are bidirectional, allowing positive shutoff with the flow in either direction.

Refer to the *VF Series Standard-Pressure, Standard-Temperature Butterfly Valves Product Bulletin (LIT-977205P)* for important product application information.

Features

- low seating/unseating torques
- bubble-tight shutoff
- broad range of pre-assembled actuators

- compatible with all types of American National Standards Institute (ANSI) 125/150 slip-on and weld-neck flanges
- high-integrity components
- air supply pressure of 70 psig to 90 psig (80 psig nominal; 140 psig maximum)
- valve assemblies for on/off applications come standard with a 24 VAC or 120 VAC solenoid valve with speed controls
- valve assemblies for proportional applications come standard with a valve actuator positioner



Three-Way, Industrial-Grade, Spring-Return, V-919x Series High-Pressure Pneumatically Actuated, Standard-Pressure, Standard-Temperature Butterfly Valve Assemblies

Repair Information

If the VF Series Butterfly Valve Assembly fails to operate within its specifications, refer to the *VF Series Standard-Pressure, Standard-Temperature Butterfly Valves Product Bulletin (LIT-977205P)* for a list of repair parts available.

Selection Chart

Valve Code Number	Actuator				On/Off ¹	Proportional (with Positioner)
	Size, in.	Cv at 90°	Cv at 60°	Closeoff Pressure, psig		
Three-Way, Spring Return² — 175 psig Closeoff Pressure; 75 psig Dead-End Service						
VFD-020HB	2	144	61	175	VFD-020HB-330C	VFD-020HB-330B
VFD-025HB	2-1/2	282	107	175	VFD-025HB-340C	VFD-025HB-340B
VFD-030HB	3	461	154	175	VFD-030HB-340C	VFD-030HB-340B
VFD-040HB	4	841	274	175	VFD-040HB-432C	VFD-040HB-432B
VFD-050HB	5	1,376	428	175	VFD-050HB-442C	VFD-050HB-442B
VFD-060HB	6	1,850	567	175	VFD-060HB-530C	VFD-060HB-530B
VFD-080HB	8	3,316	1,081	175	VFD-080HB-640C	VFD-080HB-640B
VFD-100HB	10	5,430	1,710	175	VFD-100HB-740C	VFD-100HB-740B
VFD-120HB	12	8,077	2,563	175	VFD-120HB-830C	VFD-120HB-830B
Three-Way, Spring Return² — 50 psig Closeoff Pressure; Not Rated for Dead-End Service						
VFD-040LB	4	841	274	50	VFD-040LB-340C	VFD-040LB-340B
VFD-050LB	5	1,376	428	50	VFD-050LB-432C	VFD-050LB-432B
VFD-060LB	6	1,850	567	50	VFD-060LB-442C	VFD-060LB-442B
VFD-080LB	8	3,316	1,081	50	VFD-080LB-530C	VFD-080LB-530B
VFD-100LB	10	5,430	1,710	50	VFD-100LB-640C	VFD-100LB-640B
VFD-120LB	12	8,077	2,563	50	VFD-120LB-740C	VFD-120LB-740B

1. On/off assemblies come with a 120 VAC solenoid valve and speed controls. If a 24 VAC solenoid valve is desired, change the **C** at the end of the code number to an **E**.
 2. Code numbers listed are three-way valves, style **D**. For styles **E**, **F**, or **G**, change the **D** in the third digit of the code number to the desired style. Example: VFE-xxxxx-xxxx, VFF-xxxxx-xxxx, or VFG-xxxxx-xxxx. See the following figure.

Three-Way, Industrial-Grade, Spring-Return, V-919x Series High-Pressure Pneumatically Actuated, Standard-Pressure, Standard-Temperature Butterfly Valve Assemblies (Continued)

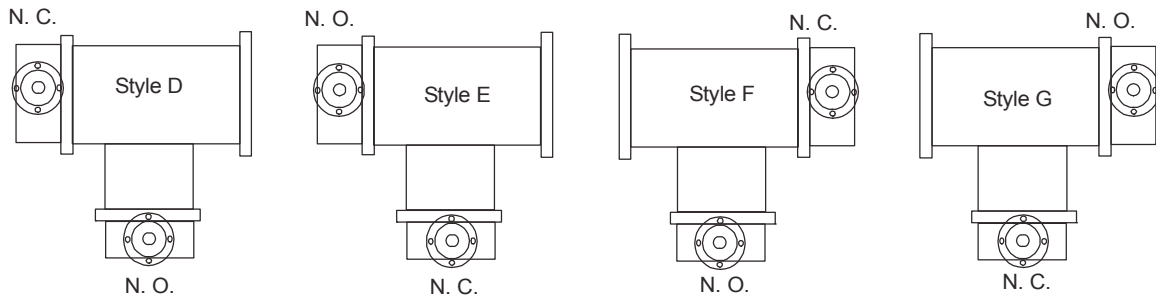

Three-Way Valve Body Styles

Technical Specifications

Three-Way, Industrial-Grade, Spring-Return, V-919x Series High-Pressure Pneumatically Actuated, Standard-Pressure, Standard-Temperature Butterfly Valve Assemblies ¹		
Service	Hot, Chilled, or Condenser Water, and 50/50 Glycol Solutions (Not Designed for Use in Steam Applications)	
Body Styles and Sizes	Three-Way, 2 in. through 12 in., Fully Lugged	
Fluid Temperature Limits	-20°F to 250°F (-29°C to 121°C)	
Body Pressure Rating	175 psig	
Maximum Fluid Velocity	30 ft/second (9 m/second)	
Rangeability	Refer to the <i>VF Series Standard-Pressure, Standard-Temperature Butterfly Valves Product Bulletin (LIT-977205P)</i> .	
Leakage	Bubble Tight	
Flow Characteristics	Modified Equal Percentage	
Materials	Body	Cast Iron, ASTM A126 Class B
	Tee (Three-Way Valves Only)	Cast Iron
	Disc	Ductile Iron, Nylon 11 Coated, ASTM A536 Gr 65-45-12
	Seat	Ethylene Propylene Diene Monomer (EPDM)
	Stem	416 Stainless Steel
Ambient Temperature Limits	Storage	-20°F to 150°F (-29°C to 66°C), Preferably 40°F to 85°F (4°C to 29°C)
	Operating	-20°F to 200°F (-29°C to 95°C)

1. Refer to the *VF Series Standard-Pressure, Standard-Temperature Butterfly Valves Product Bulletin (LIT-977205P)* for actuator specifications.

Three-Way, Industrial-Grade, Non-Spring-Return, V-909x Series High-Pressure Pneumatically Actuated, Standard-Pressure, Standard-Temperature Butterfly Valve Assemblies

Description

VF Series Three-Way, Industrial-Grade, Non-Spring-Return, V-909x Series High-Pressure Pneumatically Actuated, Standard-Pressure, Standard-Temperature Butterfly Valves are specifically designed for a wide range of HVAC applications, including two-position and modulating control of hot, chilled, or condenser water, and 50/50 glycol solutions. All valves are factory tested for bubble-tight shutoff at 100% of the fully rated pressure. These valves are bidirectional, allowing positive shutoff with the flow in either direction.

Refer to the *VF Series Standard-Pressure, Standard-Temperature Butterfly Valves Product Bulletin (LIT-977205P)* for important product application information.

Features

- low seating/unseating torques
- bubble-tight shutoff
- broad range of pre-assembled actuators

- compatible with all types of American National Standards Institute (ANSI) 125/150 slip-on and weld-neck flanges
- high-integrity components
- air supply pressure of 70 psig to 90 psig (80 psig nominal; 140 psig maximum)
- valve assemblies for On/Off applications come standard with a 24 VAC or 120 VAC solenoid valve with speed controls
- valve assemblies for proportional applications come standard with a valve actuator positioner



Three-Way, Industrial-Grade, Non-Spring-Return, V-909x Series High-Pressure Pneumatically Actuated, Standard-Pressure, Standard-Temperature Butterfly Valve Assemblies

Repair Information

If the VF Series Butterfly Valve Assembly fails to operate within its specifications, refer to the *VF Series Standard-Pressure, Standard-Temperature Butterfly Valves Product Bulletin (LIT-977205P)* for a list of repair parts available.

Selection Chart

Valve Code Number	Actuator				On/Off ¹	Proportional (with Positioner)
	Size, in.	Cv at 90°	Cv at 70°	Closeoff Pressure, psig		
Three-Way, Non-Spring Return² — 175 psig Closeoff Pressure, 75 psig Dead-End Service						
VFD-020HB	2	144	84	175	VFD-020HB-020C	VFD-020HB-020B
VFD-025HB	2-1/2	282	163	175	VFD-025HB-020C	VFD-025HB-020B
VFD-030HB	3	461	267	175	VFD-030HB-020C	VFD-030HB-020B
VFD-040HB	4	841	496	175	VFD-040HB-030C	VFD-040HB-030B
VFD-050HB	5	1,376	775	175	VFD-050HB-030C	VFD-050HB-030B
VFD-060HB	6	1,850	1,025	175	VFD-060HB-040C	VFD-060HB-040B
VFD-080HB	8	3,316	1,862	175	VFD-080HB-042C	VFD-080HB-042B
VFD-100HB	10	5,430	2,948	175	VFD-100HB-060C	VFD-100HB-060B
VFD-120HB	12	8,077	4,393	175	VFD-120HB-060C	VFD-120HB-060B
Three-Way, Non-Spring Return² — 50 psig Closeoff Pressure; Not Rated for Dead-End Service						
VFD-040LB	4	841	496	50	VFD-040LB-030C	VFD-040LB-030B
VFD-050LB	5	1,376	775	50	VFD-050LB-030C	VFD-050LB-030B
VFD-060LB	6	1,850	1,025	50	VFD-060LB-030C	VFD-060LB-030B
VFD-080LB	8	3,316	1,862	50	VFD-080LB-042C	VFD-080LB-042B
VFD-100LB	10	5,430	2,948	50	VFD-100LB-042C	VFD-100LB-042B
VFD-120LB	12	8,077	4,393	50	VFD-120LB-060C	VFD-120LB-060B

1. On/off assemblies come with a 120 VAC solenoid valve and speed controls. If a 24 VAC solenoid valve is desired, change the **C** at the end of the code number to an **E**.
2. Code numbers listed are three-way valves, style **D**. For styles **E**, **F**, or **G**, change the **D** in the third digit of the code number to the desired style. Example: VFE-xxxxx-xxxx, VFF-xxxxx-xxxx, or VFG-xxxxx-xxxx. See the following figure.

Three-Way, Industrial-Grade, Non-Spring-Return, V-909x Series High-Pressure Pneumatically Actuated, Standard-Pressure, Standard-Temperature Butterfly Valve Assemblies (Continued)

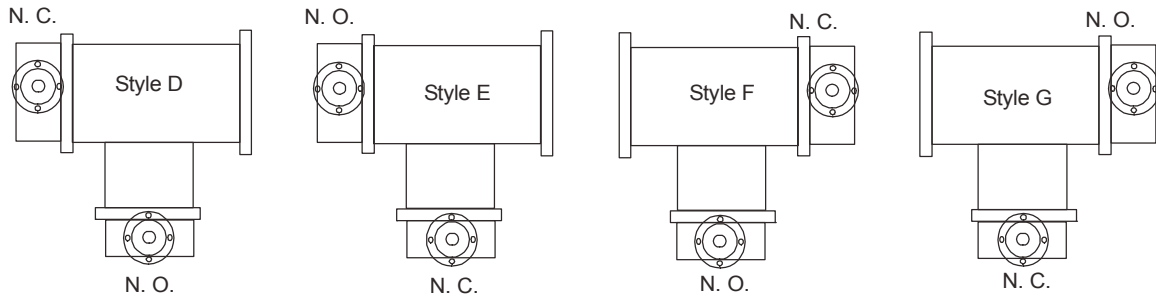

Three-Way Valve Body Styles

Technical Specifications

Three-Way, Industrial-Grade, Non-Spring-Return, V-909x Series High-Pressure Pneumatically Actuated, Standard-Pressure, Standard-Temperature Butterfly Valve Assemblies¹		
Service	Hot, Chilled, or Condenser Water, and 50/50 Glycol Solutions (Not Designed for Use in Steam Applications)	
Body Styles and Sizes	Three-Way, 2 in. through 12 in., Fully Lugged	
Fluid Temperature Limits	-20°F to 250°F (-29°C to 121°C)	
Body Pressure Rating	175 psig	
Maximum Fluid Velocity	30 ft/second (9 m/second)	
Rangeability	Refer to the <i>VF Series Standard-Pressure, Standard-Temperature Butterfly Valves Product Bulletin (LIT-977205P)</i> .	
Leakage	Bubble Tight	
Flow Characteristics	Modified Equal Percentage	
Materials	Body	Cast Iron, ASTM A126 Class B
	Tee (Three-Way Valves Only)	Cast Iron
	Disc	Ductile Iron, Nylon 11 Coated, ASTM A536 Gr 65-45-12
	Seat	Ethylene Propylene Diene Monomer (EPDM)
	Stem	416 Stainless Steel
Ambient Temperature Limits	Storage	-20°F to 150°F (-29°C to 66°C), Preferably 40°F to 85°F (4°C to 29°C)
	Operating	-40°F to 200°F (-40°C to 95°C)

1. Refer to the *VF Series Standard-Pressure, Standard-Temperature Butterfly Valves Product Bulletin (LIT-977205P)* for actuator specifications.

VF Series Two-Way, Industrial-Grade, Non-Spring Return, VA-907X Series Electric Actuated, High-Pressure, High-Temperature Butterfly Valve Assemblies

Description

VF Series Two-Way, Industrial-Grade, Non-Spring Return, VA-907X Series Electric Actuated, High-Pressure, High-Temperature Butterfly Valve Assemblies are specifically designed for a wide range of Heating, Ventilating, and Air Conditioning (HVAC) applications including two-position and modulating/throttling control of hot water, chilled water, condenser water, and steam. Refer to the *VF Series High-Pressure, High-Temperature Butterfly Valves for Steam Service Application Note (LIT-977321)* for more information on steam applications. These lug-style valves offer bidirectional shutoff at full-rated American National Standards Institute (ANSI) Class 150 and 300 operating pressures, increasing the range of applications—particularly in high-rise building HVAC control applications. ANSI Class 150 and 300 models are also suitable for steam applications.

Refer to the *VF Series High-Pressure, High-Temperature Butterfly Valves Product Bulletin (LIT-977208)* for important product application information.

Features

- compatible with all types of ANSI 150/300 slip-on and weld-neck flanges
- high-pressure, high-temperature design
- bidirectional shutoff, dead-end service
- live-loaded seat design with fully encased O-ring
- double offset stem design
- broad range of compact pre-assembled actuators available
- direct actuator-to-stem mounting

Repair Information

If the Two-Way, Industrial-Grade, Non-Spring Return, VA-90xx Series Electric Actuated, High-Pressure, High-Temperature Butterfly Valve fails to operate within its specifications, refer to the *VF Series High-Pressure, High-Temperature Butterfly Valves Product Bulletin (LIT-977208)* for a list of replacement parts available.



Two-Way, Industrial-Grade, Non-Spring Return, VA-907X Series Electric Actuated, High-Pressure, High-Temperature Butterfly Valve Assemblies

Selection Chart

Actuator				AC 120 V Powered Actuator		AC 24 V Powered Actuator	
Size, in.	Cv at 90°	Cv at 60°	Closeoff Pressure ¹	On/Off	0 VDC to 10 VDC Proportional	On/Off	0 VDC to 10 VDC Proportional
Two-Way, Normally Closed – ANSI Class 300 Flanges²							
2-1/2	160	78	550 psig	VFC-025ZE-722D	VFC-025ZE-702N	VFC-025ZE-722D4	VFC-025ZE-702N4
3	185	123		VFC-030ZE-722D	VFC-030ZE-702N	VFC-030ZE-722D4	VFC-030ZE-702N4
4	375	250		VFC-040ZE-723D	VFC-040ZE-703N	VFC-040ZE-725D4	VFC-040ZE-705N4
5	790	360		VFC-050ZE-725D	VFC-050ZE-705N	VFC-050ZE-725D4	VFC-050ZE-705N4
6	1,000	530		VFC-060ZE-726D	VFC-060ZE-706N	VFC-060ZE-727D4	VFC-060ZE-707N4
8	2,000	950		VFC-080ZE-727D	VFC-080ZE-707N	VFC-080ZE-727D4	VFC-080ZE-707N4
10	2,650	1,025		VFC-100ZE-927D	VFC-100ZE-907N	—	—
12	4,000	1,690		VFC-120ZE-927D	VFC-120ZE-907N	—	—
14	4,100	1,770		VFC-140ZE-928D	VFC-140ZE-908N	—	—
Two-Way, Normally Closed – ANSI Class 150 Flanges³							
2-1/2	160	78	240 psig	VFC-025VE-722D	VFC-025VE-702N	VFC-025VE-722D4	VFC-025VE-702N4
3	185	123		VFC-030VE-722D	VFC-030VE-702N	VFC-030VE-722D4	VFC-030VE-702N4
4	375	250		VFC-040VE-722D	VFC-040VE-702N	VFC-040VE-722D4	VFC-040VE-702N4
5	790	360		VFC-050VE-724D	VFC-050VE-704N	VFC-050VE-725D4	VFC-050VE-705N4
6	1,350	510		VFC-060VE-725D	VFC-060VE-705N	VFC-060VE-725D4	VFC-060VE-705N4
8	2,800	1,060		VFC-080VE-725D	VFC-080VE-705N	VFC-080VE-725D4	VFC-080VE-705N4
10	4,300	1,630		VFC-100VE-726D	VFC-100VE-706N	VFC-100VE-727D4	VFC-100VE-707N4
12	6,650	2,530		VFC-120VE-727D	VFC-120VE-707N	—	—
14	7,650	2,900		VFC-140VE-927D	VFC-140VE-907N	—	—
16	9,800	3,170		VFC-160VE-927D	VFC-160VE-907N	—	—

1. Close-off pressures are dimensioned for a valve seat retainer that is oriented upstream.
 2. Maximum closeoff pressure for ANSI Class 300 valves is 740 psig (5102.1 kPa) for fluid temperatures below 100°F (37.8°C), and 550 psig (3,790 kPa) for fluid temperatures at 250°F (121.1°C). Maximum steam pressure is 150 psig (1034.2 kPa) for On/Off service, and 50 psig (344.8 kPa) for proportional service.
 3. Maximum closeoff pressure for ANSI Class 150 valves is 285 psig (1965 kPa) for fluid temperatures below 100°F (37.8°C), and 240 psig (1654.8 kPa) for fluid temperatures at 250°F (121.1°C). Maximum steam pressure is 150 psig (1034.2 kPa) for On/Off service, and 50 psig (344.8 kPa) for proportional service.

VF Series Two-Way, Industrial-Grade, Non-Spring Return, VA-907X Series Electric Actuated, High-Pressure, High-Temperature Butterfly Valve Assemblies (Continued)

Technical Specifications

Two-Way, Industrial-Grade, Non-Spring Return, VA-907x Series Electric Actuated, High-Pressure, High-Temperature Butterfly Valve Assemblies ¹		
Service		Hot Water, Chilled Water, Condenser Water, and Steam ²
Body Styles and Sizes		Two-Way, 2-1/2 in. through 16 in., Fully Lugged ³
Fluid Temperature Limits		-40°F to 500°F (-40°C to 260°C)
Maximum Closeoff Pressure	2-1/2 through 16 in. ANSI Class 150 Valves (Type V)	240 psig (1,654 kPa) at 250°F (121°C) Fluid Temperature, Bidirectional ³ 240 psig (1,654 kPa) at 250°F (121°C) Fluid Temperature, Dead-End Service ^{3, 4}
	2-1/2 through 14 in. ANSI Class 300 Valves (Type Z)	550 psig (3,790 kPa) at 250°F (121°C) Fluid Temperature, Bidirectional ^{3, 5} 550 psig (3,790 kPa) at 250°F (121°C) Fluid Temperature, Dead-End Service ^{3, 4, 5}
Materials	Body	Carbon Steel, ASTM A216 GR WCB/A516 GR 70
	Disc	Stainless Steel, ASTM A 351 GR CF8M
	Seat Assembly	RTFE with Silicone Rubber O-Ring
	Seat Retainer	Carbon Steel, ASTM A516 GR 70
	Stem	17-4 PH Stainless Steel, ASTM A564-Type 630
Ambient Storage Temperature Limits		-20°F to 150°F (-29°C to 66°C); Preferably 40°F to 85°F (4°C to 29°C)

1. Refer to the *VF Series High-Pressure, High-Temperature Butterfly Valves Product Bulletin (LIT-977208)* for actuator specifications.
2. Type **V** and **Z** valves are rated for 150 psig (1,034 kPa) saturated steam at 366°F (186°C) for two-position applications, and 50 psig (345 kPa) saturated steam at 297°F (147°C) for modulating applications. Refer to the *VF Series High-Pressure, High-Temperature Butterfly Valves for Steam Service Application Note (LIT-977321)* for more information.
3. For 18 in. or larger ANSI Class 150 valves and 16 in. or larger ANSI Class 300 valves, consult the local Johnson Controls office.
4. The preferred orientation of the seat retainer in dead-end service is against the flange.
5. For pressures between 550 and 740 psig (3,790 and 5,099 kPa), consult the local Johnson Controls office.

Two-Way, Industrial-Grade, Non-Spring-Return, V-909x Series High-Pressure Pneumatically Actuated, High-Pressure, High-Temperature Butterfly Valve Assemblies

Description

VF Series Two-Way, Industrial-Grade, Non-Spring-Return, V-909x Series High-Pressure Pneumatically Actuated, High-Pressure, High-Temperature Butterfly Valve Assemblies are specifically designed for a wide range of HVAC applications, including two-position and modulating/throttling control of hot water, chilled water, condenser water, and steam. Refer to the *VF Series High-Pressure, High-Temperature Butterfly Valves for Steam Application Note (LIT 977321)* for more information on steam applications. These lug-style valves offer bidirectional shutoff at full-rated American National Standards Institute (ANSI) Class 150 and 300 operating pressures, increasing the range of applications—particularly in high-rise building HVAC control applications. ANSI Class 150 and 300 models are also suitable for steam applications.

Refer to the *VF Series High-Pressure, High-Temperature Butterfly Valves Product Bulletin (LIT-977208)* for important product application information.

Features

- compatible with all types of ANSI 150/300 slip-on and weld-neck flanges
- high-pressure, high-temperature design
- bidirectional shutoff, dead-end service
- live-loaded seat design with fully encased O-ring
- double offset stem design
- broad range of compact pre-assembled actuators available
- direct actuator-to-stem mounting

Repair Information

If the VF Series Butterfly Valve Assembly fails to operate within its specifications, refer to the *VF Series High-Pressure, High-Temperature Butterfly Valves Product Bulletin (LIT-977208)* for a list of repair parts available.



Two-Way, Industrial-Grade, Non-Spring-Return, V-909x Series High-Pressure Pneumatically Actuated, High-Pressure, High-Temperature Butterfly Valve Assemblies

Selection Chart

Valve Code Number	Actuator				On/Off ¹	Proportional (with Positioner)
	Size, in.	Cv at 90°	Cv at 70°	Closeoff Pressure, psig		
Two-Way, Normally Closed — ANSI Class 300 Flanges²						
VFC-025ZE	2-1/2	160	100	550	VFC-025ZE-030C	VFC-025ZE-030B
VFC-030ZE	3	185	155		VFC-030ZE-030C	VFC-030ZE-030B
VFC-040ZE	4	375	315		VFC-040ZE-040C	VFC-040ZE-040B
VFC-050ZE	5	790	500		VFC-050ZE-042C	VFC-050ZE-042B
VFC-060ZE	6	1,000	710		VFC-060ZE-050C	VFC-060ZE-050B
VFC-080ZE	8	2,000	1,360		VFC-080ZE-060C	VFC-080ZE-060B
VFC-100ZE	10	2,650	1,740		VFC-100ZE-070C	VFC-100ZE-070B
VFC-120ZE	12	4,000	2,500		VFC-120ZE-070C	VFC-120ZE-070B
VFC-140ZE	14	4,100	2,600		VFC-140ZE-080C	VFC-140ZE-080B
Two-Way, Normally Closed — ANSI Class 150 Flanges³						
VFC-025VE	2-1/2	160	100	240	VFC-025VE-030C	VFC-025VE-030B
VFC-030VE	3	185	155		VFC-030VE-030C	VFC-030VE-030B
VFC-040VE	4	375	315		VFC-040VE-030C	VFC-040VE-030B
VFC-050VE	5	790	500		VFC-050VE-042C	VFC-050VE-042B
VFC-060VE	6	1,350	750		VFC-060VE-042C	VFC-060VE-042B
VFC-080VE	8	2,800	1,590		VFC-080VE-050C	VFC-080VE-050B
VFC-100VE	10	4,300	2,430		VFC-100VE-060C	VFC-100VE-060B
VFC-120VE	12	6,650	3,750		VFC-120VE-070C	VFC-120VE-070B
VFC-140VE	14	7,650	4,300		VFC-140VE-070C	VFC-140VE-070B
VFC-160VE	16	9,800	5,510		VFC-160VE-080C	VFC-160VE-080B

1. On/off assemblies come with 120 VAC solenoid valve and speed controls. If a 24 VAC solenoid is desired, change the **C** at the end of the code number to an **E**.
2. Maximum closeoff pressure for ANSI Class 300 valves is 740 psig (5,102.1 kPa) for fluid temperatures below 100°F (37.8°C), and 550 psig (3,790 kPa) for fluid temperatures at 250°F (121.1°C). Maximum steam pressure is 150 psig (1,034.2 kPa) for on/off service, and 50 psig (344.8 kPa) for proportional service.
3. Maximum closeoff pressure for ANSI Class 150 valves is 285 psig (1,965 kPa) for fluid temperatures below 100°F (37.8°C), and 240 psig (1,654.8 kPa) for fluid temperatures at 250°F (121.1°C). Maximum steam pressure is 150 psig (1,034.2 kPa) for on/off service, and 50 psig (344.8 kPa) for proportional service.

Two-Way, Industrial-Grade, Non-Spring-Return, V-909x Series High-Pressure Pneumatically Actuated, High-Pressure, High-Temperature Butterfly Valve Assemblies (Continued)

Technical Specifications

Two-Way, Industrial-Grade, Non-Spring-Return, V-909x Series High-Pressure Pneumatically Actuated, High-Pressure, High-Temperature Butterfly Valve Assemblies ¹		
Service		Hot, Chilled, or Condenser Water, and Steam ²
Body Styles and Sizes		Two-Way, 2-1/2 in. through 16 in., Fully Lugged ³
Fluid Temperature Limits		-40°F to 500°F (-40°C to 260°C)
Maximum Closeoff Pressure	2-1/2 through 16 in. ANSI Class 150 Valves (Type V)	240 psig (1,654 kPa) at 250°F (121°C) Fluid Temperature, Bidirectional ³ 240 psig (1,654 kPa) at 250°F (121°C) Fluid Temperature, Dead-End Service ^{3, 4}
	2-1/2 through 14 in. ANSI Class 300 Valves (Type Z)	550 psig (3,790 kPa) at 250°F (121°C) Fluid Temperature, Bidirectional ^{3, 5} 550 psig (3,790 kPa) at 250°F (121°C) Fluid Temperature, Dead-End Service ^{3, 4, 5}
Materials	Body	Carbon Steel, ASTM A216 GR WCB/A516 GR 70
	Disk	Stainless Steel, ASTM A 351 GR CF8M
	Seat Assembly	RTFE with Silicone Rubber O-Ring
	Seat Retainer	Carbon Steel, ASTM A516 GR 70
	Stem	17-4 PH Stainless Steel, ASTM A564-Type 630
Ambient Storage Temperature Limits		-20°F to 150°F (-29°C to 66°C); Preferably 40°F to 85°F (4°C to 29°C)

1. Refer to the *VF Series High-Pressure, High-Temperature Butterfly Valves Product Bulletin (LIT-977208)* for actuator specifications.
2. Types **V** and **Z** valves are rated for 150 psig (1,034 kPa) saturated steam at 366°F (186°C) for two-position applications, and 50 psig (345 kPa) saturated steam at 297°F (147°C) for modulating applications. Refer to the *VF Series High-Pressure, High-Temperature Butterfly Valves for Steam Service Application Note (LIT-977321)* for more information.
3. For 18 in. or larger ANSI Class 150 valves and 16 in. or larger ANSI Class 300 valves, consult the local Johnson Controls® office.
4. The preferred orientation of the seat retainer in dead-end service is against the flange.
5. For pressures between 550 and 740 psig (3,790 and 5,099 kPa), consult the local Johnson Controls office.

Two-Way, Industrial-Grade, Spring-Return, V-919x Series High-Pressure Pneumatically Actuated, High-Pressure, High-Temperature Butterfly Valve Assemblies

Description

VF Series Two-Way, Industrial-Grade, Spring-Return, V-919x Series High-Pressure Pneumatically Actuated, High-Pressure, High-Temperature Butterfly Valve Assemblies are specifically designed for a wide range of HVAC applications, including two-position and modulating/throttling control of hot water, chilled water, condenser water, and steam. Refer to the *VF Series High-Pressure, High-Temperature Butterfly Valves for Steam Service Application Note (LIT 977321)* for more information on steam applications. These lug-style valves offer bidirectional shutoff at full-rated American National Standards Institute (ANSI) Class 150 and 300 operating pressures, increasing the range of applications—particularly in high-rise building HVAC control applications. ANSI Class 150 and 300 models are also suitable for steam applications.

Refer to the *VF Series High-Pressure, High-Temperature Butterfly Valves Product Bulletin (LIT-977208)* for important product application information.

Features

- compatible with all types of ANSI 150/300 slip-on and weld-neck flanges
- high-pressure, high-temperature design
- bidirectional shutoff, dead-end service
- live-loaded seat design with fully encased O-ring
- double offset stem design
- broad range of compact pre-assembled actuators available
- direct actuator-to-stem mounting

Repair Information

If the VF Series Butterfly Valve Assembly fails to operate within its specifications, refer to the *VF Series High-Pressure, High-Temperature Butterfly Valves Product Bulletin (LIT-977208)* for a list of repair parts available.



Two-Way, Industrial-Grade, Spring-Return, V-919x Series High-Pressure Pneumatically Actuated, High-Pressure, High-Temperature Butterfly Valve Assemblies

Selection Chart

Valve Code Number	Actuator				On/Off ¹		Proportional (with Positioner)	
	Size, in.	Cv at 90°	Cv at 70°	Closeoff Pressure, psig	Spring Closed	Spring Open	Spring Closed	Spring Open
Two-Way, Normally Closed — ANSI Class 300 Flanges²								
VFC-024ZE	2-1/2	160	100	550	VFC-024ZE-432C	VFN-025ZE-422C	VFC-025ZE-432B	VFN-025ZE-422B
VFC-030ZE	3	185	155		VFC-030ZE-442C	VFN-030ZE-422C	VFC-030ZE-442B	VFN-030ZE-422B
VFC-040ZE	4	375	315		VFC-040ZE-452C	VFN-040ZE-432C	VFC-040ZE-452B	VFN-040ZE-432B
VFC-050ZE	5	790	500		VFC-050ZE-650C	VFN-050ZE-630C	VFC-050ZE-650B	VFN-050ZE-630B
VFC-060ZE	6	1,000	710		VFC-060ZE-660C	VFN-060ZE-630C	VFC-060ZE-660B	VFN-060ZE-630B
VFC-080ZE	8	2,000	1,360		VFC-080ZE-750C	VFN-080ZE-730C	VFC-080ZE-750B	VFN-080ZE-730B
VFC-100ZE	10	2,650	1,740		VFC-100ZE-840C	VFN-100ZE-830C	VFC-100ZE-840B	VFN-100ZE-830B
VFC-120ZE	12	4,000	2,500		VFC-120ZE-850C	VFN-120ZE-840C	VFC-120ZE-850B	VFN-120ZE-840B
Two-Way, Normally Closed — ANSI Class 150 Flanges³								
VFC-025VE	2-1/2	160	100	240	VFC-025VE-360C	VFN-025VE-340C	VFC-025VE-360B	VFN-025VE-340B
VFC-030VE	3	185	155		VFC-030VE-360C	VFN-030VE-340C	VFC-030VE-360B	VFN-030VE-340B
VFC-040VE	4	375	315		VFC-040VE-430C	VFN-040VE-440C	VFC-040VE-430B	VFN-040VE-440B
VFC-050VE	5	790	500		VFC-050VE-462C	VFN-050VE-530C	VFC-050VE-462B	VFN-050VE-530B
VFC-060VE	6	1,350	750		VFC-060VE-550C	VFN-060VE-530C	VFC-060VE-550B	VFN-060VE-530B
VFC-080VE	8	2,800	1,590		VFC-080VE-650C	VFN-080VE-630C	VFC-080VE-650B	VFN-080VE-630B
VFC-100VE	10	4,300	2,430		VFC-100VE-750C	VFN-100VE-730C	VFC-100VE-750B	VFN-100VE-730B
VFC-120VE	12	6,650	3,750		VFC-120VE-830C	VFN-120VE-820C	VFC-120VE-830B	VFN-120VE-820B
VFC-140VE	14	7,650	4,300		VFC-140VE-850C	VFN-140VE-830C	VFC-140VE-850B	VFN-140VE-830B

1. On/off assemblies come with 120 VAC solenoid valve and speed controls. If a 24 VAC solenoid is desired, change the C at the end of the code number to an E.
2. Maximum closeoff pressure for ANSI Class 300 valves is 740 psig (5,102.1 kPa) for fluid temperatures below 100°F (37.8°C), and 550 psig (3,790 kPa) for fluid temperatures at 250°F (121.1°C). Maximum steam pressure is 150 psig (1,034.2 kPa) for on/off service, and 50 psig (344.8 kPa) for proportional service.
3. Maximum closeoff pressure for ANSI Class 150 valves is 285 psig (1,965 kPa) for fluid temperatures below 100°F (37.8°C), and 240 psig (1,654.8 kPa) for fluid temperatures at 250°F (121.1°C). Maximum steam pressure is 150 psig (1,034.2 kPa) for on/off service, and 50 psig (344.8 kPa) for proportional service.

Two-Way, Industrial-Grade, Spring-Return, V-919x Series High-Pressure Pneumatically Actuated, High-Pressure, High-Temperature Butterfly Valve Assemblies (Continued)

Technical Specifications

Two-Way, Industrial-Grade, Spring-Return, V-919x Series High-Pressure Pneumatically Actuated, High-Pressure, High-Temperature Butterfly Valve Assemblies ¹		
Service	Hot, Chilled, or Condenser Water, and Steam ²	
Body Styles and Sizes	Two-Way, 2-1/2 in. through 14 in., Fully Lugged ³	
Fluid Temperature Limits	-40°F to 500°F (-40°C to 260°C)	
Maximum Closeoff Pressure	2-1/2 through 14 in. ANSI Class 300 Valves (Type Z)	550 psig (3,790 kPa) at 250°F (121°C) Fluid Temperature, Bidirectional ^{3, 4} 550 psig (3,790 kPa) at 250°F (121°C) Fluid Temperature, Dead-End Service ^{3, 4, 5}
Materials	Body	Carbon Steel, ASTM A216 GR WCB/A516 GR 70
	Disc	Stainless Steel, ASTM A 351 GR CF8M
	Seat Assembly	RTFE with Silicone Rubber O-Ring
	Seat Retainer	Carbon Steel, ASTM A516 GR 70
	Stem	17-4 PH Stainless Steel, ASTM A564-Type 630
Ambient Storage Temperature Limits	-20°F to 150°F (-29°C to 66°C); Preferably 40°F to 85°F (4°C to 29°C)	

1. Refer to the *VF Series High-Pressure, High-Temperature Butterfly Valves Product Bulletin (LIT-977208)* for actuator specifications.
2. Types **V** and **Z** valves are rated for 150 psig (1,034 kPa) saturated steam at 366°F (186°C) for two-position applications, and 50 psig (345 kPa) saturated steam at 297°F (147°C) for modulating applications. Refer to the *VF Series High-Pressure, High-Temperature Butterfly Valves for Steam Service Application Note (LIT-977321)* for more information.
3. For 18 in. or larger ANSI Class 150 valves and 16 in. or larger ANSI Class 300 valves, consult the local Johnson Controls® office.
4. The preferred orientation of the seat retainer in dead-end service is against the flange.
5. For pressures between 550 and 740 psig (3,790 and 5,099 kPa), consult the local Johnson Controls office.

Two-Way, Manually Operated, High-Pressure, High-Temperature Butterfly Valve Assemblies

Description

VF Series Two-Way, Manually Operated, High-Pressure, High-Temperature Butterfly Valve Assemblies are specifically designed for a wide range of HVAC applications, including two-position and modulating/throttling control of hot water, chilled water, condenser water, and steam. Refer to the *VF Series High-Pressure, High-Temperature Butterfly Valves for Steam Service Application Note (LIT 977321)* for more information on steam applications. These lug-style valves offer bidirectional shutoff at full-rated American National Standards Institute (ANSI) Class 150 and 300 operating pressures, increasing the range of applications—particularly in high-rise building HVAC control applications. ANSI Class 150 and 300 models are also suitable for steam applications.

Refer to the *VF Series High-Pressure, High-Temperature Butterfly Valves Product Bulletin (LIT-977208)* for important product application information.

Features

- compatible with all types of ANSI 150/300 slip-on and weld-neck flanges
- high-pressure, high-temperature design
- bidirectional shutoff, dead-end service
- live-loaded seat design with fully encased O-ring
- double offset stem design
- broad range of compact pre-assembled actuators available
- direct actuator-to-stem mounting



Two-Way, Manually Operated, High-Pressure, High-Temperature Butterfly Valve Assemblies

Repair Information

If the VF Series Butterfly Valve Assembly fails to operate within its specifications, refer to the *VF Series High-Pressure, High-Temperature Butterfly Valves Product Bulletin (LIT-977208)* for a list of repair parts available.

Selection Chart

Valve Code Number	Actuator			Ten-Position Manual Handle	Gear-Operated Manual Hand Wheel
	Size, in.	Cv at 90°	Closeoff Pressure, psig		
Two-Way, Manually Operated — ANSI Class 300 Flanges¹					
VFM-025ZE	2-1/2	160	550	VFM-025ZE-000M	VFM-025ZE-000G
VFM-030ZE	3	185		VFM-030ZE-000M	VFM-030ZE-000G
VFM-040ZE	4	375		VFM-040ZE-000M	VFM-040ZE-000G
VFM-050ZE	5	790		VFM-050ZE-000M	VFM-050ZE-000G
VFM-060ZE	6	1,000		VFM-060ZE-000M	VFM-060ZE-000G
VFM-080ZE	8	2,000			VFM-080ZE-000G
VFM-100ZE	10	2,650			VFM-100ZE-000G
VFM-120ZE	12	4,000			VFM-120ZE-000G
VFM-140ZE	14	4,100			VFM-140ZE-000G
Two-Way, Manually Operated — ANSI Class 150 Flanges²					
VFM-025VE	2-1/2	160	240	VFM-025VE-000M	VFM-025VE-000G
VFM-030VE	3	185		VFM-030VE-000M	VFM-030VE-000G
VFM-040VE	4	375		VFM-040VE-000M	VFM-040VE-000G
VFM-050VE	5	790		VFM-050VE-000M	VFM-050VE-000G
VFM-060VE	6	1,350		VFM-060VE-000M	VFM-060VE-000G
VFM-080VE	8	2,800			VFM-080VE-000G
VFM-100VE	10	4,300			VFM-100VE-000G
VFM-120VE	12	6,650			VFM-120VE-000G
VFM-140VE	14	7,650			VFM-140VE-000G

1. Maximum closeoff pressure for ANSI Class 300 valves is 740 psig (5,102.1 kPa) for fluid temperatures below 100°F (37.8°C), and 550 psig (3,790 kPa) for fluid temperatures at 250°F (121.1°C). Maximum steam pressure is 150 psig (1,034.2 kPa) for on/off service, and 50 psig (344.8 kPa) for proportional service.
 2. Maximum closeoff pressure for ANSI Class 150 valves is 285 psig (1,965 kPa) for fluid temperatures below 100°F (37.8°C), and 240 psig (1,654.8 kPa) for fluid temperatures at 250°F (121.1°C). Maximum steam pressure is 150 psig (1,034.2 kPa) for on/off service, and 50 psig (344.8 kPa) for proportional service.

Two-Way, Manually Operated, High-Pressure, High-Temperature Butterfly Valve Assemblies (Continued)

Technical Specifications

Two-Way, Manually Operated, High-Pressure, High-Temperature Butterfly Valve Assemblies ¹		
Service		Hot, Chilled, or Condenser Water, and Steam ²
Body Styles and Sizes		Two-Way, 2-1/2 in. through 14 in., Fully Lugged ³
Fluid Temperature Limits		-40°F to 500°F (-40°C to 260°C)
Maximum Closeoff Pressure	2-1/2 through 14 in. ANSI Class 300 Valves (Type Z)	550 psig (3,790 kPa) at 250°F (121°C) Fluid Temperature, Bidirectional ^{3, 4}
		550 psig (3,790 kPa) at 250°F (121°C) Fluid Temperature, Dead-End Service ^{3, 4, 5}
Materials	Body	Carbon Steel, ASTM A216 GR WCB/A516 GR 70
	Disc	Stainless Steel, ASTM A 351 GR CF8M
	Seat Assembly	RTFE with Silicone Rubber O-Ring
	Seat Retainer	Carbon Steel, ASTM A516 GR 70
	Stem	17-4 PH Stainless Steel, ASTM A564-Type 630
Ambient Storage Temperature Limits		-20°F to 150°F (-29°C to 66°C); Preferably 40°F to 85°F (4°C to 29°C)

1. Refer to the *VF Series High-Pressure, High-Temperature Butterfly Valves Product Bulletin (LIT-977208)* for actuator specifications.
2. Types **V** and **Z** valves are rated for 150 psig (1,034 kPa) saturated steam at 366°F (186°C) for two-position applications, and 50 psig (345 kPa) saturated steam at 297°F (147°C) for modulating applications. Refer to the *VF Series High-Pressure, High-Temperature Butterfly Valves for Steam Service Application Note (LIT-977321)* for more information.
3. For 18 in. or larger ANSI Class 150 valves and 16 in. or larger ANSI Class 300 valves, consult the local Johnson Controls® office.
4. The preferred orientation of the seat retainer in dead-end service is against the flange.
5. For pressures between 550 and 740 psig (3,790 and 5,099 kPa), consult the local Johnson Controls office.

VA-9070 Series Electric Rotary Actuators for Two-Position and Modulating Service

Description

The VA-9070 Series Electric Rotary Actuators for Two-Position and Modulating Service are designed for direct mounting on VF Series Butterfly Valves. The VA-9070 is available in eight different sizes, for two-position and modulating service on VF Series Standard-Pressure, Standard-Temperature Butterfly Valves and VF Series High-Pressure, High-Temperature Butterfly Valves.

Refer to the *VA-9070 Series Electric Rotary Actuators for Two-Position and Modulating Service Product Bulletin (LIT-977319)* for important product application information.

Features

- low profile and lightweight design
- built-in motor overload protection
- pre-wired actuator switches to terminal block; field-configurable power and input signals
- patented travel limit switch cam design
- external manual handwheel override
- rugged, die-cast aluminum National Electrical Manufacturers' Association (NEMA) 4, 4X, IP65 Type enclosure and captive housing screws
- valve status display
- heater/thermostat



VA-9070 Series Electric Rotary Actuator Mounted on a VF Series Butterfly Valve

Repair Information

If the VA-9070 Series Electric Rotary Actuators for Two-Position and Modulating Service fails to operate within its specifications, refer to the *VA-9070 Series Electric Rotary Actuators for Two-Position and Modulating Service Product Bulletin (LIT-977319)* for a list of repair parts available.

Selection Charts

Code Numbers and Cross-Reference Data (Part 1 of 2)

Johnson Controls® Actuator Only Code Number	Johnson Controls® VF Series Butterfly Valve Assembly Actuator Sub-code	Bray® Series Number
Electric Two-Position Models		
VA-9072-02	-722	S70-006 On-Off
VA-9075-02	-725	S70-020 On-Off
VA-9076-02	-726	S70-030 On-Off
VA-9077-02	-727	S70-050 On-Off
VA-9078-02	-728	S70-065 On-Off
VA-9072-12	-722D4	S70-006 On-Off, AC 24V
VA-9075-12	-725D4	S70-020 On-Off, AC 24V
VA-9077-12	-727D4	S70-050 On-Off, AC 24V
VA-907A-02	-927	S70-130 On-Off
VA-907B-02	-928	S-180 On-Off

Code Numbers and Cross-Reference Data (Part 2 of 2)

Johnson Controls® Actuator Only Code Number	Johnson Controls® VF Series Butterfly Valve Assembly Actuator Sub-code	Bray® Series Number
Electric Modulating Models		
VA-9072-01	-702	S70-006 Modulating
VA-9075-01	-705	S70-020 Modulating
VA-9076-01	-706	S70-030 Modulating
VA-9077-01	-707	S70-050 Modulating
VA-9078-01	-708	S70-065 Modulating
VA-9072-11	-702N4	S70-006 Modulating, AC 24V
VA-9075-11	-705N4	S70-020 Modulating, AC 24V
VA-9077-11	-707N4	S70-050 Modulating, AC 24V
VA-907A-01	-907	S70-130 Modulating
VA-907B-01	-908	S70-180 Modulating

**VA-9070 Series Electric Rotary Actuators for Two-Position and Modulating Service
(Continued)
Accessories**

Description	Code Number
Servo Kit	For All Models of VA-9070 Series Modulating Electric Actuators VA-907x-630
Thermostat/Heater Kit	For All Models of VA-9070 Series Two-Position and Modulating Electric Actuators VA-907x-609
Mounting and Adaptor Kits for Standard-Pressure, Standard-Temperature Two-Way VF Series Butterfly Valves	Mounts VA-9072 Series Two-Position and Modulating Electric Actuators on 2 through 3 in. Valves VA-9072-300
	Mounts VA-9072 Series Two-Position and Modulating Electric Actuators on 4 in. Valves VA-9072-400
	Mounts VA-9072 Series Two-Position and Modulating Electric Actuators on 5 and 6 in. Valves VA-9072-600
	Mounts VA-9075 Series Two-Position and Modulating Electric Actuators on 4 in. Valves VA-9075-400
	Mounts VA-9075 Series Two-Position and Modulating Electric Actuators on 5 and 6 in. Valves VA-9075-600
	Mounts VA-9075 Series Two-Position and Modulating Electric Actuators on 8 in. Valves VA-9075-800
	Mounts VA-9075 Series Two-Position and Modulating Electric Actuators on 10 and 12 in. Valves VA-9075-1200
	Mounts VA-9076, VA-9077, and VA-9078 Series Two-Position and Modulating Electric Actuators on 8 in. Valves VA-9078-800
	Mounts VA-9076, VA-9077, and VA-9078 Series Two-Position and Modulating Electric Actuators on 10 and 12 in. Valves VA-9078-1200
	Mounts VA-9076, VA-9077, and VA-9078 Series Two-Position and Modulating Electric Actuators on 14 and 16 in. Valves VA-9078-1600
	Mounts VA-907A Series Two-Position and Modulating Electric Actuators on 16 in. Valves VA-9078-2000
	Mounts VA-9076, VA-9077, and VA-9078 Series Two-Position and Modulating Electric Actuators on 18 and 20 in. Valves VA-9078-2000
	Mounts VA-907A Series Two-Position and Modulating Electric Actuators on 18 in. Valves VA-9078-2000
	Mounts VA-907B Series Two-Position and Modulating Electric Actuators on 20 in. Valves VA-9078-2000
Mounting and Adaptor Kits for Class 150 High-Pressure, High-Temperature Two-Way VF Series Butterfly Valves	Mounts VA-9072 Series Two-Position and Modulating Electric Actuators on 2 through 3 in. Valves VA-9072-300
	Mounts VA-9072 Series Two-Position and Modulating Electric Actuators on 4 in. Valves VA-9072-400
	Mounts VA-9072 Series Two-Position and Modulating Electric Actuators on 5 and 6 in. Valves VA-9072-600
	Mounts VA-9072 Series Electric Actuators on 2-1/2 through 4 in. Valves VA-9072-410
	Mounts VA-9075 Series Electric Actuators on 5 in. and on 6 in. Valves VA-9075-610
	Mounts VA-9076 Series Electric Actuators on 8 in. Valves VA-9078-810
Mounting and Adaptor Kits for Class 300 High-Pressure, High-Temperature Two-Way VF Series Butterfly Valves	Mounts VA-9077 Series Electric Actuators on 10 in. and VA-9078 Series Electric Actuators on 12 in. Valves VA-9078-1210
	Mounts VA-907A Series Electric Actuators on 14 in. Valves VA-9078-1600
	Mounts VA-907A Series Electric Actuators on 16 in. Valves VA-9078-2000
	Mounts VA-9075 Series Electric Actuators on 2-1/2 through 4 in. Valves VA-9075-430
	Mounts VA-9075 Series Electric Actuators on 5 in. Valves VA-9075-530
	Mounts VA-9076 Series Electric Actuators on 6 in. Valves VA-9075-630
Local Control Station	For All Models of VA-9070 Series Modulating Electric Actuators; Kit Includes Local and Remote Control Switch, Open-Stop-Close Switch, and Two LEDs for Position Indication (Green for Open and Red for Closed) VA-907X-620
Auxiliary Switch Kits	Single Auxiliary Switch for VA-9074 and VA-9075 Series Modulating Electric Actuators VA-907X-601
	Single Auxiliary Switch for VA-9076, VA-9077, and VA-9078 Series Modulating Electric Actuators VA-907X-602
	Single Auxiliary Switch for VA-9074 and VA-9075 Series Two-Position Electric Actuators VA-907X-603
	Single Auxiliary Switch for VA-9076, VA-9077, and VA-9078 Series Two-Position Electric Actuators VA-907X-604
	Two Auxiliary Switches for VA-9074 and VA-9075 Series Two-Position Electric Actuators VA-907X-605
	Two Auxiliary Switches for VA-9076, VA-9077, and VA-9078 Series Two-Position Electric Actuators VA-907X-606
Feedback Potentiometer Kits	Feedback Potentiometer Kit, 5,000 Ohm, Gear Driven for VA-907x Series Proportional Non-Spring Return Electric Actuators VA-907X-615

VA-9070 Series Electric Rotary Actuators for Two-Position and Modulating Service (Continued)

VA-9070 Series Electric Rotary Actuators Motor Ratings and Operating Speeds

Actuator Series: Johnson Controls Code Number (Bray Series Number)	50/60 Hz Single Phase Motors: Current Rating in Amperes at All Speeds		Two-Position and Modulating Speeds for 90° Operation in Seconds ¹ (Total Gear Ratio)
	VAC	Amperes	
VA-9072 (S70-006)	120	1.0	30 seconds (11,151:1)
	24	1.8 at 60 Seconds	60 seconds
VA-9075 (S70-020)	120	1.0	30 seconds (3,340:1)
	24	2.0	60 seconds
VA-9076 (S70-030)	120	1.2	
VA-9077 (S70-050)	120	1.6	
	24	3.0	60 seconds
VA-9078 (S70-065)	120	2.3	
VA-907A (S70-130)	120	2.3	110 seconds (10,000:1)
VA-907B (S70-180)	120	2.5	

1. The duty cycle for two-position and modulating operation is 100% at a maximum ambient temperature of 104°F (40°C).

VA-9070 Series Electric Rotary Actuators Output Torque Values, Rim Pull, and Mounting Data

Actuator Series: Johnson Controls Code Number (Bray Series Number)	Output Torque lb-in (N·m)	Rim Pull lb (kg)	Net Weight lb (kg)
VA-9072 (S70-006)	600 (68)	22.8 (10.3)	12.0 (5.4)
VA-9075 (S70-020)	2,000 (226)	33.0 (15.0)	28.0 (12.7)
VA-9076 (S70-030)	3,000 (339)	33.0 (15.0)	48.0 (21.8)
VA-9077 (S70-050)	5,000 (565)	55.0 (25.0)	
VA-9078 (S70-065)	6,500 (734)	72.0 (32.7)	
VA-907A (S70-130)	13,000 (1,470)	80.0 (36.2)	118.0 (53.5)
VA-907B (S70-180)	18,000 (2,030)		

Technical Specifications

VA-9070 Series Electric Rotary Actuators

Supply Voltage	120 VAC, 50/60 Hz or 24 VAC 50/60 Hz
Limit Switches	Two SPDT (Single-Pole, Double-Throw) switches rated for 10 amperes (75 to 80% power factor), 1/3 hp 120 VAC and 1/2 hp 220 VAC
Control Signal, Proportional Models	4 to 20 mA, 0 to 5 VDC, 0 to 10 VDC, or 2 to 10 VDC, field-selectable
Ambient Temperature Limits	-20°F to 150°F (-29°C to 66°C); Heater/Thermostat Kit Required below 32°F (0°C)
Agency Listings	Models for 120 VAC Voltage (VA-907x-0x): UL File number E200414; CSA reference LR 78858; CE compliant. All VA-9070 actuators are CSA approved under Class 3211 07 Industrial Control Equipment - Miscellaneous Apparatus. The CSA certificate number is LR78858-4 issued July 1996 to Bray Controls for the Series 70 actuators, NEMA 4, and NEMA 4X.

V-9000 Series Rotary Motion Rack and Pinion Pneumatic Actuators for Butterfly Valves

Description

The V-9000 Series Rack and Pinion Pneumatic Actuators are designed for direct mounting on Johnson Controls® VF Series Butterfly Valves. The actuators are available in eight sizes with torque output capacities capable of automating VF Series Butterfly Valves up to 20 in. (508 mm) in size.

Refer to the *V-9000 Series Rotary Motion Rack and Pinion Pneumatic Actuators for Butterfly Valves (LIT-977260)* for important product application information.

Features

- compact modular design
- low-friction piston guides and rings
- built-in shaft position indicator and travel stops
- full range of modular add-on control accessories

Repair Information

If the V-9000 Series Pneumatic Actuator fails to operate within its specifications, replace the unit. For a replacement actuator, contact the nearest Johnson Controls representative.

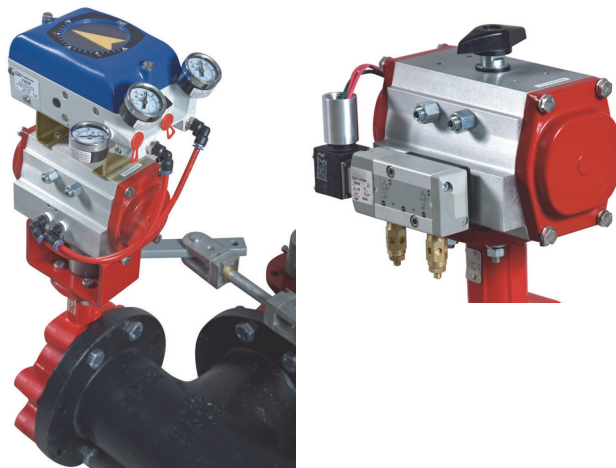

V-9000 Series Rotary Motion Rack and Pinion Pneumatic Actuators for Butterfly Valves

Selection Charts

V-909x Series Actuator Torque Data (lb-in) and Ordering Data (Double Acting)

Code Number	Supply Pressure, psig (kPa)					VF Series Code Number ¹	Actuator Air Volume, cubic in.	Shipping Weight, lb
	40 (280)	60 (420)	80 (560)	100 (700)	120 (840)			
V-9092-1	145	221	297	373	449	-020	9.35	3.4
V-9093-1	351	536	721	906	1,091	-030	20.5	6.3
V-9094-1	493	753	1,013	1,272	1,532	-040	28.9	8.5
V-9094-2	1,058	1,615	2,171	2,728	3,285	-042	62.0	16.9
V-9096-1	2,797	4,270	5,742	7,214	8,687	-060	140.6	38.8
V-9097-1	5,783	8,826	11,870	14,914	17,957	-070	309.5	77.8
V-9098-1	14,211	21,691	29,171	36,650	44,130	-080	734.1	167.0

1. Refer to the ordering data templates in the *VF Series Standard-Pressure, Standard-Temperature Butterfly Valves Product Bulletin (LIT-977205P)* and the *VF Series High-Pressure, High-Temperature Butterfly Valves Product Bulletin (LIT-977208)* for full code numbers.

V-919x Series Actuator Torque Data (lb-in) and Ordering Data (Spring Return) (Part 1 of 2)

Code Number	Air Stroke Supply Pressure, psig (kPa)										Spring Stroke		Weight, lb
	40 (280)		60 (420)		80 (560)		100 (700)		120 (840)		NO Start	NC End	
	NC ¹ Start	NO ¹ End	NC Start	NO End	NC Start	NO End	NC Start	NO End	NC Start	NO End			
V-9193-12	210	167	395	352	580	537	765	722	950	907	184	141	6.0
V-9193-13	156	76	341	261	526	446	711	631	896	816	275	195	6.3
V-9193-14			281	176	466	361	651	546	836	731	360	255	6.6
V-9193-16					369	185	554	370	739	555	536	352	7.1
V-9194-12	310	232	570	492	830	752	1,089	1,011	1,349	1,271	261	183	8.0
V-9194-13	218	101	478	361	738	621	997	880	1,257	1,140	392	275	8.4
V-9194-14			386	231	646	491	905	750	1,165	1,010	522	367	8.8
V-9194-15			294	94	554	354	813	613	1,073	873	659	459	9.1
V-9194-16					462	229	721	488	981	748	784	551	9.5
V-9194-22	692	469	1,249	1,026	1,805	1,582	2,362	2,139	2,919	2,696	589	366	18.1
V-9194-23	509	174	1,066	731	1,622	1,287	2,179	1,844	2,736	2,401	884	549	18.8
V-9194-24			883	437	1,439	993	1,996	1,550	2,553	2,107	1,178	732	19.5
V-9194-25			700	142	1,256	698	1,813	1,255	2,370	1,812	1,473	915	20.3
V-9194-26					1,073	404	1,630	961	2,187	1,518	1,767	1,098	21.0
V-9195-13			1,357	733	2,099	1,475	2,841	2,217	3,583	2,959	1,419	795	22.1
V-9195-15					1,568	529	2,310	1,271	3,052	2,013	2,365	1,326	24.2

V-9000 Series Rotary Motion Rack and Pinion Pneumatic Actuators for Butterfly Valves (Continued)

V-919x Series Actuator Torque Data (lb-in) and Ordering Data (Spring Return) (Part 2 of 2)

Code Number	Air Stroke Supply Pressure, psig (kPa)										Spring Stroke		Weight, lb
	40 (280)		60 (420)		80 (560)		100 (700)		120 (840)		NO Start	NC End	
	NC ¹ Start	NO ¹ End	NC Start	NO End	NC Start	NO End	NC Start	NO End	NC Start	NO End			
V-9196-12	1,819	1,118	3,292	2,591	4,764	4,063	6,236	5,535	7,709	7,008	1,679	978	39.7
V-9196-13	1,399	349	2,872	1,822	4,344	3,294	5,816	4,766	7,289	6,239	2,448	1,398	42.1
V-9196-14			2,452	1,123	3,924	2,595	5,396	4,067	6,869	5,540	3,147	1,818	44.5
V-9196-15			2,030	353	3,502	1,825	4,974	3,297	6,447	4,770	3,917	2,240	46.8
V-9196-16					3,154	1,196	4,626	2,668	6,099	4,141	4,546	2,588	49.2
V-9197-12	3,833	2,508	6,876	5,551	9,920	8,595	12,964	11,639	16,007	14,682	3,275	1,950	75.1
V-9197-13	2,859	868	5,902	3,911	8,946	6,955	11,990	9,999	15,033	13,042	4,915	2,924	80.2
V-9197-14			4,930	2,275	7,974	5,319	11,018	8,363	14,061	11,406	6,551	3,896	85.2
V-9197-15			3,949	638	6,993	3,682	10,037	6,726	13,080	9,769	8,188	4,877	90.3
V-9197-16					6,022	2,031	9,066	5,075	12,109	8,118	9,839	5,848	95.3
V-9198-12	9,487	6,747	16,967	14,227	24,447	21,707	31,926	29,186	39,406	36,666	7,464	4,724	160.2
V-9198-13	7,125	3,015	14,605	10,495	22,085	17,975	29,564	25,454	37,044	32,934	11,196	7,086	168.3
V-9198-14			12,243	6,762	19,723	14,242	27,202	21,721	34,682	29,201	14,929	9,448	176.4
V-9198-15			9,880	3,030	17,360	10,510	24,839	17,989	32,319	25,469	18,661	11,811	184.5
V-9198-16					14,998	6,778	22,477	14,257	29,957	21,737	22,393	14,173	192.6

1. N.C. is the abbreviation for Normally Closed; N.O. is the abbreviation for Normally Open.

V-919x Series Ordering Data

Code Number	VF Series Code Number ¹	Total Actuator Air Volume Required for 90° Rotation, cubic in.	Total Number of Springs in Actuator ²
V-9193-12	-320	32.6	4
V-9193-13	-330		6
V-9193-14	-340		8
V-9193-16	-360		12
V-9194-12	-420	45.9	4
V-9194-13	-430		6
V-9194-14	-440		8
V-9194-15	-450		10
V-9194-16	-460	12	
V-9194-22	-422	95.5	4
V-9194-23	-432		6
V-9194-24	-442		8
V-9195-13	-530	130.8	6
V-9195-15	-550		10
V-9196-12	-620	259.6	4
V-9196-13	-630		6
V-9196-14	-640		8
V-9196-15	-650		10
V-9196-16	-660		12
V-9197-12	-720	450	4
V-9197-13	-730		6
V-9197-14	-740		8
V-9197-15	-750		10
V-9197-16	-760		12
V-9198-12	-820		900
V-9198-13	-830	6	
V-9198-14	-840	8	
V-9198-15	-850	10	
V-9198-16	-860	12	

1. Refer to the ordering data templates in the VF Series Standard-Pressure, Standard-Temperature Butterfly Valves Product Bulletin (LIT-977205P) and the VF Series High-Pressure, High-Temperature Butterfly Valves Product Bulletin (LIT-977208) for full code numbers.

2. The numbers listed are the total number of springs in the actuator; the last digit of the code number suffix indicates the number of springs per piston. There are two pistons per actuator.

V-9000 Series Rotary Motion Rack and Pinion Pneumatic Actuators for Butterfly Valves (Continued)

Accessories

Solenoid Valves Including Mounting Hardware

Code Number and Features		Description
V-9000-146 ¹		120 VAC Solenoid Air Valve, Four-Way, for New Style V-9092 to V-9094-1 and V-9193 to V-9194-1 Series Actuators
V-9000-147 ¹		120 VAC Solenoid Air Valve, Four-Way, for New Style V-9094-2 to V-9098 and V-9194-2 to V-9198 Series Actuators
Features	Voltage Requirements	120 VAC
	Power Consumption	AC: 5.6 VA; DC: 7.2 W
	Maximum Pressure	140 psig (980 kPa)
	Ambient Temperature Limits	0°F to 180°F (-18°C to 82°C)
	Air Connections	1/4 in. NPT (Internal)
	Electrical Connections	18 AWG Leads, 24 in. (61 cm) Long
Enclosure Materials		Die-Cast Aluminum Body with NEMA 4 Coil Housing

1. For actuators manufactured after April 1, 1992

Speed Controls

Code Number	Description
V-9000-311	Brass Speed Controls (Two) for New Style ¹ V-9192 to V-9194-2 Series Actuators
V-9000-312	Brass Speed Controls (Two) for New Style ¹ V-9194-2 to V-9198 Series Actuators

1. For actuators manufactured after April 1, 1992

Plastic Position Indicators

Actuator Series	Code Number ¹
V-9x92	V-9092-611
V-9x93	V-9093-611
V-9x94-1x	V-9094-6111
V-9x94-2x	V-9094-6112
V-9x95	V-9095-611
V-9x96	V-9096-611
V-9x97	V-9097-611
V-9x98	V-9098-611

1. For actuators manufactured after April 1, 1992

Positioners

Code Number and Specifications		Description
Models		V-9000-500 Pneumatic Positioner for All Old and New Style V-9000 Series Actuators (Includes Three Gauges)
Mounting Kits	V-9000-502 ¹	Positioner Mounting Kit for Old-Style V-9x94 and V-9x95 Series Actuators
	V-9000-511 ²	Positioner Mounting Kit for New Style V-9x92 to V-9x94-1 Series Actuators
	V-9000-512 ²	Positioner Mounting Kit for New Style V-9x94-2 and V-9x95 Series Actuators
	V-9000-513 ²	Positioner Mounting Kit for New Style V-9x96 to V-9x98 Series Actuators
Air Specifications	Supply Pressure	40 to 140 psig (280 to 980 kPa) Air Supply Must be Clean (Filtered), Dry, and Oil Free.
	Output Flow Capacity	2,000 scim (546 mL/s) at 60 psig (420 kPa)
	Air Consumption	1,200 scim (328 mL/s) at 60 psig (420 kPa)
	Control Action	Direct or Reverse; Field Selectable
	Operating Range	Factory Set at 3 psig to 15 psig (21 kPa to 105 kPa) for 90° Rotation; Field Selectable at 3 psig to 15 psig for 65° Rotation or 3 psig to 9 psig (21 kPa to 63 kPa) or 9 psig to 15 psig (63 kPa to 105 kPa) for 65° Rotation
	Starting Point	Factory Set at Approximately 3 psig (21 kPa)
Ambient Temperature Limits		-5°F to 160°F (-21°C to 71°C)
Air Connections	Supply	1/4 in. NPT (Internal)
	Control Input	1/8 in. NPT (Internal)
	Outputs	1/8 in. NPT (Internal)
Materials	Body	Aluminum, Anodized
	Diaphragm	Buna-N Rubber
	Spool	Stainless Steel
	Cover	Polycarbonate

1. For actuators manufactured before April 1, 1992

2. For actuators manufactured after April 1, 1992

The performance specifications are nominal and conform to acceptable industry standards. For applications at conditions beyond these specifications, consult the local Johnson Controls office. Johnson Controls shall not be liable for damages resulting from misapplication or misuse of its products. © 2019 Johnson Controls. www.johnsoncontrols.com

V-9000 Series Rotary Motion Rack and Pinion Pneumatic Actuators for Butterfly Valves (Continued)

Travel Switches

Code Number and Specifications		Description
Travel Limit Switch Models	V-9000-400 ¹	For All V-9000 Series Actuators
Mounting Kits	V-9000-401 ¹	For V-9x92 and V-9x93 Series Actuators
	V-9000-402 ¹	For V-9x94 and V-9x95 Series Actuators
	V-9000-403 ¹	For V-9x96 and V-9x97 Series Actuators
	V-9000-404 ²	For V-9x96, V-9x97, and V-9x98 Series Actuators ³
Features	Switches	Two Single-Pole, Double-Throw (SPDT)
	Electrical Rating	5 A at 120/250 VAC; 5 A at 24 VDC
	Body Materials	Die-Cast Aluminum, NEMA 4, 4x Housing

- For actuators manufactured before April 1, 1992
- For actuators manufactured after April 1, 1992
- Mounting kits are not required for smaller size actuators (V-9x92 through V-9x95).

Pneumatic Rack and Pinion Actuator Adapter Sleeves¹

Valve Size, in.	V-9x92-xx	V-9x93-xx	V-9x94-1x	V-9x94-2x	V-9x95-xx	V-9x96-xx	V-9x97-xx	V-9x98-xx
2	Not Required	V-9094-300	V-9094-300	V-9095-300	V-9095-300			
2-1/2	Not Required	V-9094-300	V-9094-300	V-9095-300	V-9095-300			
3	Not Required	V-9094-300	V-9094-300	V-9095-300	V-9095-300			
4		V-9094-400	V-9094-400	V-9095-400	V-9095-400			
5		Not Required	Not Required	V-9095-600	V-9095-600	V-9096-600		
6		Not Required	Not Required	V-9095-600	V-9095-600	V-9096-600		
8				V-9095-800	V-9095-800	V-9096-800	V-9097-800	
10				Not Required	Not Required	Not Required	V-9097-120	
12				Not Required	Not Required	Not Required	V-9097-120	
14							V-9097-160	V-9098-100
16							V-9097-160	V-9098-100
18							Not Required	V-9098-200
20							Not Required	V-9098-200

- Adapter sleeves are required to field mount rack and pinion actuators to VFM valves.

Technical Specifications

V-9000 Series Rotary Motion Rack and Pinion Pneumatic Actuators for Butterfly Valves		
Models	V-909x Series	Rack and Pinion Double Acting Actuators; See <i>V-909x Series Actuator Torque Data (lb-in) and Ordering Data (Double Acting)</i> Table for Full Code Numbers.
	V-919x Series	Rack and Pinion Spring-Return Actuators; See <i>V-919x Series Actuator Torque Data (lb-in) and Ordering Data (Spring Return)</i> Table for Full Code Numbers.
Output Torque	V-909x Series	See <i>V-909x Series Actuator Torque Data (lb-in) and Ordering Data (Double Acting)</i> .
	V-919x Series	See <i>V-919x Series Actuator Torque Data (lb-in) and Ordering Data (Spring Return)</i> .
Supply Pressure		Nominal 60 psig to 80 psig (420 kPa to 560 kPa); Minimum 40 psi (280 kPa), Maximum 140 psi (980 kPa). Air Supply Must be Clean (Filtered), Dry, and Oil Free.
Ambient Temperature Limits		-13°F to 200°F (-25°C to 93°C)
Materials	Body	Extruded Aluminum, Anodized
	End Caps	Die Cast Aluminum, Polyester Coated
	Pistons	Die Cast Aluminum
	Output Shaft	Carbon Steel, Zinc Plated
	Piston Guides	Acetal
	Spring Cartridges	Coated Spring Steel, Zinc Plated Hardware
	O-Ring Seals	Buna-N Rubber

V-9000-500 Positioner

Description

Use the V-9000-500 Positioner for modulating control of both double-acting and spring-return actuators.

When the V-9000 Series Rack and Pinion Actuator is ordered as a factory-mounted component of a complete VF Series Butterfly Valve assembly, the positioner can be ordered as a factory-installed option.

Specify code number V-9000-500 when ordering; the appropriate mounting kit must be ordered separately.

Refer to the *V-9000 Series Rotary Motion Rack and Pinion Pneumatic Actuators for Butterfly Valves Product Bulletin (LIT-977260)* for important product application information (including mounting kits).



V-9000-500 Positioner

Features

- non-interactive zero and span adjustments as well as field-selectable direct or reverse action
- furnished with supply, input, and output gauges as well as a visual position indicator through the clear polycarbonate cover of the unit

Repair Information

If the V-9000-500 Positioner fails to operate within its specifications, replace the unit. For a replacement positioner, contact the nearest Johnson Controls® representative.

Selection Chart

Code Number	Description
V-9000-500	Positioner

Mounting Kits (Order Separately)

Code Number	Description
V-9000-511 ¹	Positioner Mounting Kit for New Style V-9x92 to V-9x94-1 Series Actuators
V-9000-512 ¹	Positioner Mounting Kit for New Style V-9x94-2 and V-9x95 Series Actuators
V-9000-513 ¹	Positioner Mounting Kit for New Style V-9x96 to V-9x98 Series Actuators

1. For actuators manufactured after April 1, 1992

Technical Specifications

V-9000-500 Positioner		
Air Specifications	Supply Pressure	40 psig to 140 psig (276 kPa to 965 kPa) Air Supply Must be Clean (Filtered), Dry, and Oil Free.
	Output Flow Capacity	2,000 scim (546 mL/s) at 60 psig (414 kPa)
	Air Consumption	1,200 scim (328 mL/s) at 60 psig (414 kPa)
	Control Action	Direct or Reverse; Field Selectable
	Operating Range	Factory Set at 3 psig to 15 psig (21 kPa to 103 kPa) for 90° Rotation; Field Selectable at 3 psig to 15 psig for 65° Rotation or 3 psig to 9 psig (21 kPa to 62 kPa) or 9 psig to 15 psig (62 kPa to 103 kPa) for 65° Rotation
	Starting Point	Factory Set at Approximately 3 psig (21 kPa)
	Ambient Temperature Limits	-5°F to 160°F (-21°C to 71°C)
Air Connections	Supply	1/4 in. NPT (Internal)
	Control Input	1/8 in. NPT (Internal)
	Outputs	1/8 in. NPT (Internal)

V-3766, V-3966, and V-4332 Brass Pneumatic Flare Valves, 1/2 in. Two-Way and Three-Way

Description

The 1/2 in. flared valve line accurately regulates the flow of hot or cold water in small HVAC terminal units. These 1/2 in. valves are available with a factory-installed V-3000-1 exposed type pneumatic actuator; enclosed actuators (V-3000-2) are also available (order separately). This valve style is available for field mounting the VA-805x Series electric actuators or with a factory-coupled VA-805x Series electric actuator.

Refer to the *Flare Valves 1/2 in. Two-Way and Three-Way Product Bulletin (LIT-977175)* for important product application information.

Features

- 1/2 in. OD SAE 45 flare connections do not require solder installation with copper tubing; provides easy removal for maintenance
- standard Johnson Controls® non-adjustable ring pack packings provide proven reliability and long life
- body rated 400 psig static pressure does not restrict building location
- every valve tested for tight initial and long-term shutoff; ensures occupant comfort and energy conservation
- factory-assembled valves available with pneumatic or electric actuators; install quickly and easily, minimizing job site time



Brass Pneumatic Flare Valves

Selection Charts

Pneumatically Actuated V-3766, V-3966, and V-4332 Flare Valves

Valve Body	Style ¹	Max. Cv	Range-ability ²	Valve Suffix with V-3000 Actuator (Maximum Closeoff Pressure, psi ³)		
				Spring Ranges, psi		
				3 to 6	4 to 8	9 to 13
V-3766	N.O.	1.0	7:1	-1001 (345)		
	N.O.	1.7	12:1	-1002 (345)		
	N.O.	3.2	23:1	-1003 (345)		
V-3966	N.C.	1.7	12:1			-1001 (240)
	N.C.	3.2	23:1			-1002 (240)
V-4332	MIX	1.2	7:1		-1007 (240/240)	-1004 (240/240)
	MIX	2.0	12:1		-1009 (240/240)	-1006 (240/240)

1. Normally Open (N.O.); Normally Closed (N.C.); Mixing Valve (MIX); maximum closeoff pressure (N.C. port/N.O. port)
2. Rangeability is defined as the ratio of maximum flow to minimum controllable flow.
3. Maximum closeoff pressures listed are for 20 psi supply pressure to diaphragm for normally open and 0 psi supply pressure to diaphragm for normally closed.

Valid Code Numbers of V-3766, V-3966, and V-4332 Flare Valve and Pneumatic Actuator Combinations

Valid Pneumatic Valve/Actuator Assembly Code Number	Spring Range, psi	Max. Cv	Style
V-3766-1001	3 to 6	1.0	N.O.
V-3766-1002	3 to 6	1.7	
V-3766-1003	3 to 6	3.2	
V-3966-1001	9 to 13	1.7	N.C.
V-3966-1002	9 to 13	3.2	
V-4332-1004	9 to 13	1.2	MIX
V-4332-1006	9 to 13	2.0	
V-4332-1007	4 to 8	1.2	
V-4332-1009	4 to 8	2.0	
VB-3766-1	None	1.0	PDTC ¹
VB-3766-2	None	1.7	
VB-3766-3	None	3.2	
VB-3966-1	None	1.7	PDTO ¹
VB-3966-2	None	3.2	
VB-4332-4	None	1.2	MIX
VB-4332-5	None	2.0	

1. Push-Down-to-Close (PDTC); Push-Down-to-Open (PDTO)

Electrically Actuated VB-3766, VB-3966, and VB-4332 Flare Valves

Valve Body	Style	Max. Cv	Range-ability
VB-3766-1	PDTC	1.0	7:1
VB-3766-2	PDTC	1.7	12:1
VB-3766-3	PDTC	3.2	23:1
VB-4332-4	MIX	1.2	7:1
VB-4332-5	MIX	2.0	12:1

Valid Code Numbers of VB-3766, VB-3966, and VB-4332 Flare Valve and Electric Actuator Combinations

Actuator	Valve Body	Max. Cv	Flared Valve Body Style
VA-8050-1 Floating/ Incremental	VB-3766-1	1.0	Two-Way PDTC
	VB-3766-2	1.7	
	VB-3766-3	3.2	
	VB-4332-4	1.2	Three-Way MIX
	VB-4332-5	2.0	
VA-8051-1 Floating/ Incremental Feedback	VB-3766-1	1.0	Two-Way PDTC
	VB-3766-2	1.7	
	VB-3766-3	3.2	
	VB-4332-4	1.2	Three-Way MIX
VB-4332-5	2.0		



WARNING

This product can expose you to chemicals including lead, which is known to the State of California to cause cancer, birth defects, or other reproductive harm. For more information, go to www.P65Warnings.ca.gov.

Accessories

Code Number	Description
V-3000-8003	Enclosed V-3000 Actuator for Field Mounting
V-3000-10	Valve Position Indicator for V-3000-1 Exposed Style Pneumatically Actuated Valves
V-9502-15	Valve Positioner for Field Mounting to a V-3000-1 Exposed Style Pneumatically Actuated Valve
V-9502-20	Valve Positioner Spring for V-3000-1 Exposed Style Pneumatically Actuated Valves Using a V-9502-15 Positioner; 3.0 psi (21 kPa) Span
V-9502-101	Valve Positioner Spring for V-3000-1 Exposed Style Pneumatically Actuated Valves Using a V-9502-15 Positioner; 4.3 psi (30 kPa) Span
V-9502-19	Valve Positioner Spring for V-3000-1 Exposed Style Pneumatically Actuated Valves Using a V-9502-15 Positioner 8.0 psi (56 kPa) Span

The performance specifications are nominal and conform to acceptable industry standards. For applications at conditions beyond these specifications, consult the local Johnson Controls office. Johnson Controls shall not be liable for damages resulting from misapplication or misuse of its products. © 2019 Johnson Controls. www.johnsoncontrols.com

V-3766, V-3966, and V-4332 Brass Pneumatic Flare Valves, 1/2 in. Two-Way and Three-Way (Continued)

Repair Parts

Valve Code Number	Repair Kit Code Number	Description
V-3766 VB-3766	V-3754-6010 ¹	Spring Kit, 3-6 psig, 1/2 in. Stroke for V-3011, V-3020, V-3752, V-3755, V-4510, V-5250 (1-1/2 and 2), V-3754 (1/2 and 3/4), and V-3766 (1/2) Valve with V-3000-1 or V-3000-2 Actuator
V-3966 VB-3966	V-3754-6009 ¹	Spring Kit, 9-13 psig, 1/2 in. Stroke for V-3011, V-3020, V-3212, V-3752, V-3755, V-3970, V-4322 (1-1/2 and 2), V-3974, V-3966, V-6139 (1/2), V-3754, V-3974, V-4324 (1/2 and 3/4) Valve with V-3000-1 or V-3000-2 Actuator
V-4332 VB-4322	V-4332-6001 ¹	Spring Kit, 4-8 psig, 5/16 in. Stroke for V-3212, V-3970, V-4322 (1/2 and 3/4), V-4332, V-4333 (1/2), V-4334 (5/8), and VT Valve with V-3000-1 or V-3000-2 Actuator
	V-3752-6022 ¹	Spring Kit, 9-13 psig, 5/16 in. Stroke for V-3011, V-3020, V-3212, V-3752, V-3755, V-3970, V-4322 (1/2 and 3/4), V-4334 (5/8), V-4332, V-4333, V-5416, V-7416 (1/2), V-6143 (3/8 and 3/4) and VT Valve with V-3000-1 or V-3000-2 Actuator
All Assemblies	V-9999-608 ²	Ring Pack Packing Kits: Single Pack
	V-9999-610 ²	10 Pack (Contains Enough Materials to Repack 10 Valves)
	V-9999-630 ³	50 Pack (Contains U-Cups and O-Rings Only to Repack 50 Valves)

1. Spring kit contains: spring, upper and lower spring plate, stem extension, lock screw, and instructions.
2. Packing kit contains: O-rings, crocus cloth, assembly tool, gland nut liner, guide, extractor/installer, ring pack assembly, follower, grease, and instructions.
3. Silicone grease is not included in this kit; order V-9999-606 separately.

Technical Specifications

V-3766, V-3966, and V-4332 Brass Pneumatic Flare Valves, 1/2 in. Two-Way and Three-Way		
Models	Pneumatic	V-3766 - PDTC (Normally Open), V-3966 - PDT0 (Normally Closed), V-4332 - Three-Way Mixing
	Electric	VB-3766 - PDTC, VB-3996 - PDT0, VB-4332 - Three-Way Mixing
Service	Hot and Cold Water	
Control Air Connection (Pneumatic Operation)	1/8 in. NPT Barbed Fitting for 5/32 in. or 1/4 in. OD Polytubing for Pneumatic Actuators	
Flow Characteristics	Equal Percentage	
Actuator Sizing/Maximum Closeoff Pressure	See Selection Charts.	
Valve Stem Diameter	1/4 in.	
Flow Coefficients (Cv)	Two-Way: 1.0, 1.7, 3.2; Three-Way (Mixing): 1.2, 2.0. See Selection Charts.	
Maximum Seat Leakage	PDTC (N.O.) and PDT0 (N.C.): 0.05% of Maximum Rated Valve Capacity Three-Way Mixing: 0.5% of Maximum Rated Valve Capacity	
Maximum Recommended Differential Pressure for Valve Sizing	35 psi (245 kPa)	
Rangeability	Refer to the <i>Flare Valves 1/2 in. Two-Way and Three-Way Product Bulletin (LIT-977175)</i> .	
Valve Stroke	5/16 in.	
Maximum Allowable Pressure/Temperature	(Two-Way) V-3766, VB-3766, V-3966, VB-3966 400 psi (2,800 kPa) up to 150°F (66°C) Decreasing to 345 psi (2,415 kPa) at 281°F (140°C) (Three-Way Mixing) V-4332 and VB-4332 250 psi (1,750 kPa) Maximum at 281°F (140°C)	
Ambient Temperature Limit	-10°F to 150°F (-23°C to 66°C) for Pneumatic Actuators; -10°F to 140°F (-23°C to 60°C) with VA-805x Actuator	
Fluid Operating Temperature Limits	281°F (140°C) Maximum for Pneumatic Actuators; 195°F (90°C) Maximum with VA-805x Actuator	
Materials	Stem	Stainless Steel
	Plug	PDTC (N.O.) and PDT0 (N.C.): Brass with Molded and Bonded Composition Disc Three-Way Mixing: Brass (Metal-to-Metal Seating)
	Body	Cast Brass with Natural Finish
	Actuator	Die Cast Aluminum for Pneumatic Actuators. For Electric Actuators, Refer to the Relevant Electric Actuator Product Bulletin.
	Diaphragm	Molded Reinforced Synthetic Rubber for Pneumatic Actuators
Spring Ranges (Nominal)	3 psi to 6 psi (21 kPa to 42 kPa) N.O. only; 4 psi to 8 psi (28 kPa to 56 kPa) MIX Only; 9 psi to 13 psi (63 kPa to 91 kPa) N.C. and MIX for Pneumatic Actuators	
Body Style and Sizes	Offset Globe for 1/2 in. SAE Flared Connections	
Maximum Control Pressure	30 psi (210 kPa) for Pneumatic Actuators	



WARNING This product is made of copper alloy, which contains lead. The product is therefore not to be used on drinking water.

WARNING: BRASS MAY CONTAIN LEAD

To fulfill our obligations towards Article 33, in accordance to the European REACH Regulation No 1907/2006 EC, we hereby inform you that this article contains the following Substances of Very High Concern mentioned on the Candidate list:

- Lead

V-3802-1 Oval Top Actuator

Description

The V-3802 Pneumatic Oval Top Actuator positions steam or water valve modulating plugs in response to a pneumatic signal from a controller.

Features

- designed for use where mounting space is restricted
- die-cast aluminum housing and a molded, synthetic elastomer diaphragm that provides a constant effective area throughout the valve stem stroke
- comparatively small oval enclosed actuator has sufficient force to handle most seating pressures
- remove or reposition actuator by loosening a single set screw
- easily field mounted to the valve bonnet with a single set screw

Applications

VT Series Valves only. Also available to replace older, installed V-3800 Series Oval Top Actuators.

Not for use with VG7000 Series valves.

Selection Chart

Code Number	Description
V-3802-1	Pneumatic Oval Top Actuator

Accessories and Repair Parts

Code Number	Description
V-3100-611	Replacement Diaphragm for V-3802 Pneumatic Oval Top Actuator

Technical Specifications

V-3802-1 Oval Top Actuator	
Media Temperature	281°F Maximum
Maximum Control Pressure	30 psig
Available Spring Ranges	3 psi to 6 psi, 4 psi to 8 psi, and 9 psi to 13 psi ¹
Air Connection	1/8 in. NPT Barbed Fitting for 5/32 in. O.D. Poly tubing
Size, in.	2-7/16 H x 1-5/8 W x 4-31/32 Diameter

1. A spring is assembled with the valve body, not in the actuator. For spring kits to field mount V-3802-1 to valve bodies, refer to the *Valve Spring Kits Sorted by Valve Code Number Catalog Page (LIT-1924395)*, online or in the Johnson Controls® Valves and Actuators Catalog.

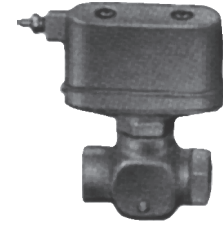

V-3802-1 Compact Actuator on a Two-Way Valve

V-4334 Flare Valve

Description

The V-4334 Three-Way Mixing Flare Valve accurately regulates the mixing of water at different temperatures in small room air conditioning units.

Refer to the *V-4334 Three-Way Cast Brass Valve for 5/8 in. O.D. Tubing S.A.E. 45° Flared Connections Product Bulletin (LIT-977180)* for important product application information.

Features

- supplied with a factory installed V-3000 exposed pneumatic actuator, which has a synthetic rubber diaphragm in a die-cast aluminum housing
- molded diaphragm provides a constant effective area throughout the valve stroke
- actuator assembly can be removed without disturbing the remainder of the valve assembly
- completely enclosed actuator can be ordered separately for field mounting (V-3000-8003)

- contains two modulating plugs, which provide a characterized relationship between valve lift and flow at a constant pressure drop
- bottom service connection is furnished with a 90° elbow that can be rotated to any position

Applications

Typically used when hot water is circulated during the heating cycle and cold water is circulated during the cooling cycle.

Repair Information

If the V-4334 Flare Valve fails to operate within its specifications, replace the valve body, actuator, or entire assembly. For replacement parts, contact the nearest Johnson Controls® representative.

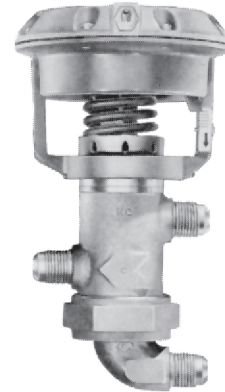

V-4334 Flare Valve

Selection Chart

Code Number	Valve Size, in.	Spring Range, psig	Max. Cv (kv)
V-4334-1001	5/8	4 to 8	4.7 (4.0)
V-4334-1002		9 to 13	

Accessories

Code Number	Description
V-3000-10	Valve Position Indicator
V-3000-8003	Enclosed V-3000 Actuator for Field Mounting
V-9502-15	Pneumatic Positioner

Technical Specifications

V-4334 Flare Valve	
Style	Cast Bronze for O.D. Tubing, S.A.E. 45° Flared Connections, 250 psig Body Rating
Valve Size	5/8 in.
Maximum Cv (kv)	4.7 (4.0)
Style	Three-Way Mixing Valve
Spring Range (Nominal)	4 psig to 8 psig and 9 psig to 13 psig
Service	Hot and Cold Water
Valve Stroke Length (Travel)	11/16 in.

WARNING

This product is made of copper alloy, which contains lead. The product is therefore not to be used on drinking water.

WARNING

This product can expose you to chemicals including lead, which is known to the State of California to cause cancer, birth defects, or other reproductive harm. For more information, go to www.P65Warnings.ca.gov.

WARNING: BRASS MAY CONTAIN LEAD

To fulfill our obligations towards Article 33, in accordance to the European REACH Regulation No 1907/2006 EC, we hereby inform you that this article contains the following Substances of Very High Concern mentioned on the Candidate list:

- Lead

V-4440 Series Water Valve 1/2 and 5/8 in. for Three- and Four-Pipe Systems

Description

The V-4440 Series Water Valve 1/2 and 5/8 in. for Three- and Four-Pipe Systems accurately regulates hot and cold water in small room air conditioning three- or four-pipe systems. The two-pipe supply system provides heating and cooling water to the room units continuously.

Refer to the *V-4440 Water Valve for Three- and Four-Pipe Systems, Cast Brass 1/2 and 5/8 in. S.A.E. 45° Flared Connections Product Bulletin (LIT-977185)* for important product application information.

Features

- supplied with a factory-installed V-3000 exposed pneumatic actuator, which has a synthetic rubber diaphragm in a die-cast aluminum housing
- molded diaphragm provides a constant diaphragm effective area throughout the stroke
- complete actuator assembly can be removed without disturbing the remainder of the valve assembly

- completely enclosed actuator (V-3000-8003 can be ordered separately for field mounting)
- valve has two inlets (upper and lower) and one outlet (center)
- lower inlet port is normally open (N.O.), and upper inlet port is normally closed (N.C.)
- V-4440 is both a switching valve and a control valve
- contains two modulating plugs with replaceable composition discs that are designed for both hot- and cold-water service
- bottom service connection is furnished with a 90° elbow that can be rotated to any position

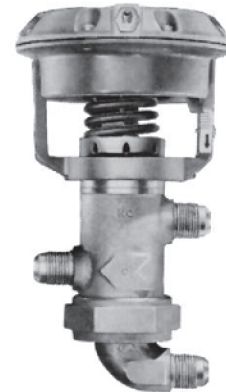

V-4440 Water Valve

Repair Information

If the V-4440 Series Water Valve fails to operate within its specifications, replace the valve body, actuator, or entire assembly. For replacement parts, contact the nearest Johnson Controls® representative.

Selection Chart

Code Number ¹	Size, in.	Max. Cv (kv) N.C. Seat ²	Body Style	Cv N.O. Seat ²
Supply Valve for Three- and Four-Pipe Systems (4 to 12 psig Spring)				
V-4440-1001	1/2	1.4 (1.2)	Three-Way 90° Elbow	1.4
V-4440-1002		2.4 (2.0)		2.4
V-4440-1003	5/8	4.1 (3.5)		4.7
V-4440-1004	1/2	1.4 (1.2)	Three-Way Straight	1.4
V-4440-1005		2.4 (2.0)		2.4
Return Valve for Four-Pipe System (6 to 9 psig Spring)				
V-4440-1008	1/2	2.4 (2.0)	Three-Way 90° Elbow	2.4
V-4440-1009	5/8	4.1 (3.5)		4.7
V-4440-1011	1/2	2.4 (2.0)	Three-Way Straight	2.4

1. With V-3000-1 Actuator Assembled and Seating Pressure 0 to 40 psig

2. N.O. = Normally Open, N.C. = Normally Closed

Technical Specifications

V-4440 Series Water Valve 1/2 and 5/8 in. for Three- and Four-Pipe Systems	
Style	Cast Bronze for 1/2 and 5/8 in. O.D. Tubing, S.A.E. 45° Flared Connections, 250 psig Body Rating
Valve Size	1/2 in. and 5/8 in.
Maximum Cv	1.4, 2.4, 4.1 (Supply Valve) 2.4, 4.1 (Return Valve)
Spring Range (Nominal)	4 psig to 12 psig (Supply Valve) and 6 psig to 9 psig (Return Valve)
Service	Hot and Cold Water
Seating Pressure	0 psig to 40 psig
Valve Stroke Length (Travel)	11/16 in.

Accessories

Code Number	Description
V-3000-10	Valve Position Indicator
V-9502-15	Pneumatic Positioner
V-3000-8003	Enclosed V-3000 Actuator for Field Mounting



WARNING This product is made of copper alloy, which contains lead. The product is therefore not to be used on drinking water.



WARNING This product can expose you to chemicals including lead, which is known to the State of California to cause cancer, birth defects, or other reproductive harm. For more information, go to www.P65Warnings.ca.gov.

WARNING: BRASS MAY CONTAIN LEAD

To fulfill our obligations towards Article 33, in accordance to the European REACH Regulation No 1907/2006 EC, we hereby inform you that this article contains the following Substances of Very High Concern mentioned on the Candidate list:

- Lead

VB-3766, VB-3966, VB-4332 Series Brass Flare Valve Bodies, 1/2 in. Two-Way and Three-Way

Description

The 1/2 in. Two-Way and Three-Way Flare Valves accurately regulate the flow of hot or cold water in small HVAC terminal units, including fan coils, perimeter radiation, and reheat coils.

Refer to the *Flare Valves 1/2 in. Two-Way and Three-Way Product Bulletin (LIT-977175)* for important product application information.

Features

- available with or without a factory coupled V-3000-1 pneumatic or VA-805x Series electric actuator; these actuators can also be field mounted
- contains a modulating plug, which provides an equal percentage relationship (two-way) and linear relationship (three-way) between valve travel and flow at a constant pressure drop
- uses standard Johnson Controls® non-adjustable ring pack packing for proven reliability and long life
- a molded composition disk that ensures tight shutoff is bonded to the valve plug assembly and can be removed for servicing

Repair Information

If the Brass Flare Valve Body fails to operate within its specifications, replace the valve body, actuator, or entire assembly. For replacement parts, contact the nearest Johnson Controls representative.

Selection Chart

Code Number	Size, in.	Maximum Cv (kv)	Stroke, in.	Style ¹	End Connection
VB-3766-1	1/2	1.0 (.85)	1/2	PDTC	Flare
VB-3766-2		1.7 (1.5)			
VB-3766-3		3.2 (2.7)			
VB-3966-1	1/2	1.7 (1.5)	1/2	PDTO	Flare
VB-3966-2		3.2 (2.7)			
VB-4332-4		1.2 (1.0)			
VB-4332-5	2.0 (1.7)				

1. Push-Down-to-Close (PDTC); Push-Down-to-Open (PDTO)

Technical Specifications

VB-3766, VB-3966, VB-4332 Series Bronze Flare Valve Bodies, 1/2 in. Two-Way and Three-Way (Part 1 of 2)	
Service	Hot and Cold Water
Valve Stem Diameter	1/4 in.
Maximum Seat Leakage	PDTC and PDTO: 0.01% of Maximum Rated Valve Capacity (Cv); Three-Way Mixing: 0.25% of Maximum Rated Valve Capacity (Cv)
Maximum Recommended Operating Differential Pressure for Valve Sizing	35 psi (245 kPa)
Valve Stroke Length (Travel)	Two-Way (VB-3766, VB-3966): 1/2 in. Three-Way (VB-4332): 5/16 in.
Maximum Allowable Pressure/Temperature	(Two-Way) VB-3766, VB-3966: 400 psi (2,800 kPa) up to 150°F (66°C) Decreasing to 345 psi (2,415 kPa) at 281°F (140°C); (Three-Way Mixing) and VB-4332: 240 psi (1,750 kPa) Maximum to 281°F (140°C)

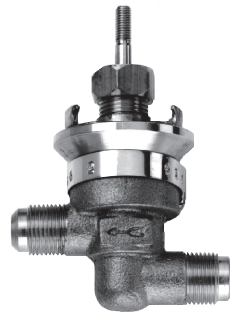

VB-3766 Series Push-Down-To-Close



VB-3966 Series Push-Down-To-Open



VB-4332 Series Three-Way Mixing

VB-3766, VB-3966, VB-4332 Series Bronze Flare Valve Bodies, 1/2 in. Two-Way and Three-Way (Part 2 of 2)		
Fluid Operating Temperature Limits	For VA-805x Electric Actuators: 35°F-195°F (2°C-90°C); For All Pneumatic Actuators: 35°F-281°F (2°C-38°C)	
Maximum Closeoff Pressures	Refer to the V-3766, V-3966, and V-4332 Brass Pneumatic Flare Valves 1/2 in. Two-Way and Three-Way Catalog Page (LIT-1924115).	
Flow Characteristics	VB-3766	PDTC: Equal Percentage
	VB-3966	PDTO: Cv 1.7: Equal Percentage; Cv 3.2: Modified Equal Percentage
	VB-4332	Both Ports: Cv 1.0/1.5 Linear; PDTC/PDTC: Cv 1.7/2.3 Quick Opening/Linear
Materials	Stem	Stainless Steel
	Plug	PDTC (N.O.) and PDTO (N.C.): Brass with Molded and Bonded Composition Disk; Three-Way Mixing: Brass (Metal-to-Metal)
	Body	Cast Bronze with Natural Finish
	Packing	Non-Adjustable EPR (Ethylene Propylene Rubber) Ring Packs
Body Style and End Connection	Offset Globe for 1/2 in. S.A.E. Flared Connections	
Rangeability and Flow Coefficient	Max. Cv (kv) — Rangeability	
	VB-3766 PDTC	1.0 (.85) — 7:1 1.7 (1.5) — 12:1 3.2 (2.7) — 23:1
	VB-3966 PDTO	1.8 (1.5) — 12:1 2.7 (2.3) — 23:1
Dimensions (End-to-End)	VB-3766, VB-4332	3-3/8 in.
	VB-3966	3-3/4 in.
Recommended Actuators	Pneumatic	V-3000-1, V-3000-8003
	Electric	VA-805x

VB-3766, VB-3966, VB-4332 Series Brass Flare Valve Bodies, 1/2 in. Two-Way and Three-Way (Continued)



This product is made of copper alloy, which contains lead. The product is therefore not to be used on drinking water.



This product can expose you to chemicals including lead, which is known to the State of California to cause cancer, birth defects, or other reproductive harm. For more information, go to www.P65Warnings.ca.gov.

WARNING: BRASS MAY CONTAIN LEAD

To fulfill our obligations towards Article 33, in accordance to the European REACH Regulation No 1907/2006 EC, we hereby inform you that this article contains the following Substances of Very High Concern mentioned on the Candidate list:

- Lead

V-3000 Series Pneumatic Actuator

Description

The V-3000 Series Pneumatic Actuator can position steam or water valve-modulating plugs in response to a pneumatic signal from a controller.

Refer to the *V-3000 Pneumatic Valve Actuator Exposed or Enclosed Product Bulletin (LIT-977250)* for important product application information.

Features

- molded synthetic rubber diaphragm design provides a constant effective area throughout the valve stem stroke
- die-cast aluminum housing coated with corrosion-resistant finish
- remove or reposition actuator by loosening a single set screw
- easily field mounted to the valve bonnet with a single set screw
- can be mounted to any of the V-3000, V-4000, or VT Series Valves (except V-3854)

Selection Chart

Code Number	Description
V-3000-1	Exposed Yoke

Accessories

Code Number	Description
V-3000-10	Valve Position Indicator
V-9502-15	Positioner Kit ¹

1. Refer to the *V-9502 Series Pneumatic Valve Actuator Positioners Product Bulletin (LIT-977265)*.

Applications

Used on 1/2 in. Flare Valves, VT Series Valves, and 3/4 to 1-1/2 Cage Trim Valves. This actuator is not used with VG7000 Series Valves.

Repair Information

If the V-3000 Series Pneumatic Actuator fails to operate within its specifications, replace the unit. For a replacement actuator, contact the nearest Johnson Controls® representative.



Exposed V-3000-1 Actuator

Technical Specifications

V-3000 Series Pneumatic Actuator	
Media Temperature	281°F Maximum
Maximum Control Pressure	30 psig
Available Spring ¹ Ranges	3 psig to 6 psig, 4 psig to 8 psig, and 9 psig to 13 psig
Air Connection	1/8 in. NPT Barbed Fitting for 5/32 in. O.D. Poly tubing
Size, in.	3 H x 4-7/16 Diameter

1. A spring is assembled with the valve body, not in the actuator. For spring kits to field mount V-3000-1 to valve bodies, refer to the *Valve Spring Kits Sorted by Valve Code Number Catalog Page (LIT-1924395)* online or in the Johnson Controls Valves and Actuators Catalog.

V-4000-1 Small Pneumatic Actuator for Small Control Valves

Description

The V-4000-1 Small Pneumatic Actuator accurately positions the modulating plugs of chilled- or hot-water control valves in response to a pneumatic signal from a controller.

Refer to the *V-4000 Small Pneumatic Actuator for Small Control Brass Valves Product Bulletin (LIT-977255)* for important product application information.

Applications

Direct replacement for all oval top (V-3800 Series) actuators (except V-3801-8001 on VG7000 Series valves).

Features

- directly replaces field installed V-3854 and V-3800 models
- tailored for small terminal unit valve applications
- direct replacement for oval top actuators (VT Series and older oval top series)

Repair Information

If the V-4000-1 Pneumatic Actuator fails to operate within its specifications, replace the unit. For a replacement actuator, contact the nearest Johnson Controls® representative.

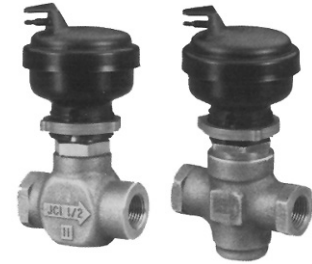

V-4000-1 Actuators

Selection Chart

Code Number	Description
V-4000-1	Small Pneumatic Actuator

Technical Specifications

V-4000-1 Small Pneumatic Actuator for Small Control Valves		
Ambient Temperature Limits		-20°F to 150°F (-29°C to 66°C)
Relative Humidity		5% to 90% RH
Fluid Operating Temperature Limits		35°F to 200°F (2°C to 93°C)
Storage Condition Limits		-20°F to 150°F (-23°C to 66°C) 5% to 95% RH
Dimensions (H x Diameter)		3.27 in. x 2.84 in. (83.1 mm x 72.1 mm)
Maximum Control Pressure		30 psig (210 kPa)
Control Signal Air Connection		Dual Barbed Fitting for 5/32 in. or 1/4 in. O.D. Tubing
Effective Diaphragm Area		4 sq. in. (2,581 sq. mm)
Materials	Yoke and Cover	Glass-Reinforced Nylon
	Piston	Glass-Reinforced Nylon
	Diaphragm	Fabric-Reinforced Synthetic Rubber
	Retaining Nut	Chromate-Coated Zinc
Available Spring Ranges		3 psi to 6 psi, 4 psi to 8 psi, and 9 psi to 13 psi ¹

1. A spring is assembled with the valve body, not in the actuator. For spring kits to field mount V-3802-1 to valve bodies, refer to the *Valve Spring Kits Sorted by Valve Code Number Catalog Page (LIT-1924395)*, online or in the Johnson Controls Valves and Actuators Catalog.

Repair Parts for Use with V-9502 Pneumatic Valve Actuator Positioner

Description

The V-9502 Pneumatic Valve Actuator Positioners can be reconditioned using the parts listed in the following selection chart.

Refer to the *V-9502 Series Pneumatic Valve Actuator Positioners Product Bulletin (LIT-977265)* for important product application information.

Selection Chart

Code Number	Callout	Description
C-9506-1	A	Positioner Movement Complete Less Items B and C
D-9502-604	B	Operating Span Lever Arm Assembly
Refer to the <i>Positioner Springs</i> tables in the <i>V-9502 Series Pneumatic Valve Actuator Positioners Product Bulletin (LIT-977265)</i> .	C	Springs

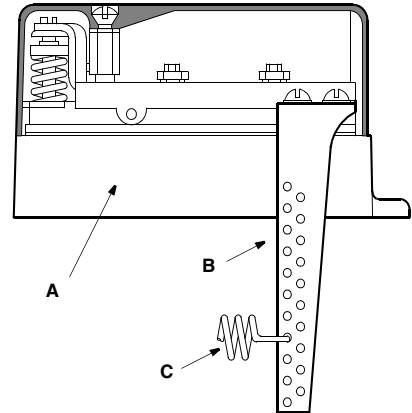

Repair Parts, V-9502

Repair Parts for Use with Electric or Pneumatic VT Series Terminal Unit Valves 1/2 in., Two-Way and Three-Way

Description

The available packing kits and spring kits can extend the service life of the VT Series valves. No inner valve kits are available for this series of valves.

Selection Charts

Ring Pack Packing Kits for VT Series Valves

Code Number	Callout	Description
V-9999-608	A	Single pack
V-9999-610		10 pack (contains enough material to repack 10 valves)
V-9999-630		50 pack (contains U-cups and O-rings only to repack 50 valves)
V-9999-649	B	Packing nut for all VT styles

Spring Kits for VT Series Valves

Code Number	Callout	Spring Range, psig	Actuator	Valve Size, in.	Valve Body
V-9999-6001 ¹	C	3 to 6	V-3802 or V-4000	1/2	VT Series
V-9999-6002 ¹		4 to 8			
V-9999-6003 ¹		9 to 13			
V-3752-6023 ²	D	3 to 6	V-3000	1/2	VT Series
V-4332-6001 ²		4 to 8			
V-3752-6022 ²		9 to 13			

1. Spring kit includes spring, upper spring seat, upper spring seat retainer, and instructions.
2. Spring kit includes spring, upper and lower spring seat, stem extension, stem lock screw, and instructions.

Tailpiece and Nut for VT Series Valves

Code Number	Description	Tube Size, in.	Valve Size, in.	Valve Body
V-9999-663	Tailpiece	3/8	1/2	VT Series
V-9999-664	Tailpiece	1/2	1/2	
V-9999-665	Tailpiece	3/4	1/2	
V-9999-666	Nut	3/8 and 1/2	1/2	
V-9999-667	Nut	3/4	1/2	

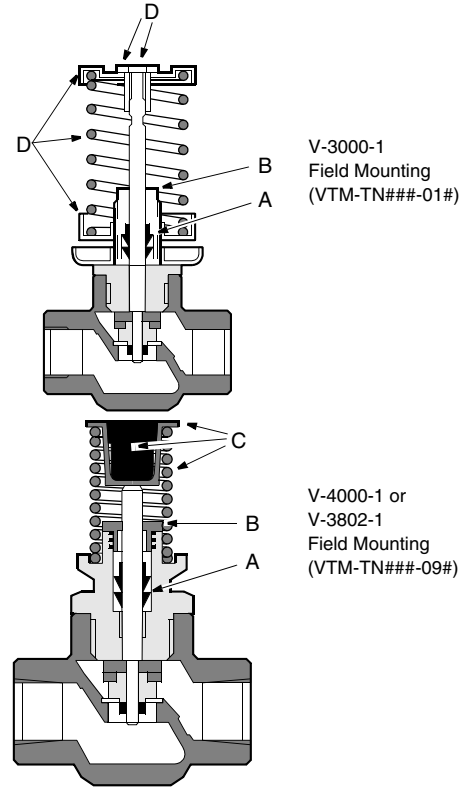

Repair Parts, VT Series Valves

Repair Parts for 1/2 in. Flare Valves for Use with V-3766, V-3966, V-4332, VB-3766, VB-3966, VB-4332, AV-8050, AV-8051, and AV-8052 (Flare Valve Assemblies)

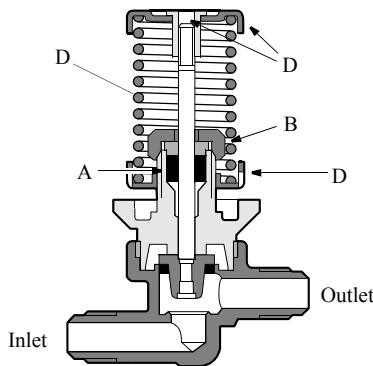

**Repair Parts,
V-3766, Normally Open
Push-Down-to-Close**

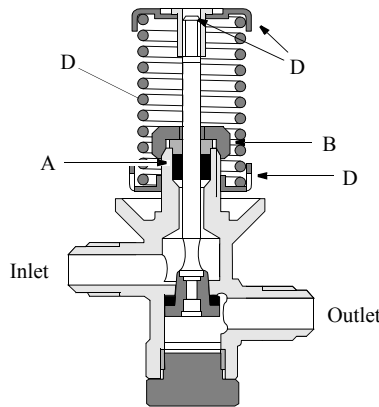

**Repair Parts,
V-3966, Normally Closed
Push-Down-to-Open**

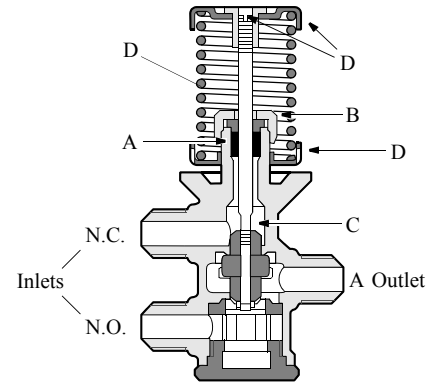

**Repair Parts,
V-4332
Three-Way Mixing**

Description

The available service parts listed in the Selection Chart can extend the service life of the V-3766, V-3966, V-4332, VB-3766, VB-3966, VB-4332, AV-8050, AV-8051, and AV-8052 Flare Valve Assemblies and in many cases return the valve to near original operating performance.

Selection Chart

Code Number	Callout	Description		
V-9999-608	A	Ring Pack		
V-9999-610		Single pack		
V-9999-630		10 pack (contains enough material to repack 10 valves) 50 pack (contains U-cups and O-rings only to repack 50 valves)		
V-3752-646	B	Gland Nut		
V-4332-615	C	Stem and Disc Assemblies¹	Valve Size, in.	Maximum Cv
V-4332-616			1/2 (V-4332, VB-4332)	1.2
V-3754-6009	D	Spring Kits²	Valve Size, in.	Range, psig
V-4332-6001			1/2	9 to 13 (V-3966 only)
V-3752-6022			1/2	4 to 8 (V-4332 only)
V-3754-6010			1/2	9 to 13 (V-4332 only) 3 to 6 (V-3766 only)

1. Assembly includes valve stem, upper and lower modulating plug, lock pins, disc and swivel, packings, and lower O-ring.
2. Spring kit includes spring, upper and lower spring seat, stem extension and lock screw, and instructions.



WARNING

This product is made of copper alloy, which contains lead. The product is therefore not to be used on drinking water.



WARNING

This product can expose you to chemicals including lead, which is known to the State of California to cause cancer, birth defects, or other reproductive harm. For more information, go to www.P65Warnings.ca.gov.

WARNING: BRASS MAY CONTAIN LEAD

To fulfill our obligations towards Article 33, in accordance to the European REACH Regulation No 1907/2006 EC, we hereby inform you that this article contains the following Substances of Very High Concern mentioned on the Candidate list:

- Lead

Repair Parts for Use with V-4334 5/8 in. Flare Valve

Description

The available service parts listed in the Selection Chart can extend the service life of the V-4334 Flare Valve Assemblies and in many cases return the valve to near original operating performance.

Selection Chart

Code Number	Call-out	Description			
		Range, psig	Valve Size, in.	Stroke, in.	
V-4332-6001	A	Springs	4 to 8	5/8	0.313
V-3752-6022			9 to 13	5/8	0.313
V-3752-646			B	Gland Nut	
V-9999-608	C	Ring Pack Packing Kits	Single pack		
V-9999-610			10 pack (contains enough material to repack 10 valves)		
V-9999-630			50 pack (contains U-cups and O-rings only to repack 50 valves)		
V-4334-6001	N/A	Reconditioning Kit ¹	Valve Size, in.	Cv	
			5/8	4.7	

1. Reconditioning kit includes cage, O-ring, plug, stem, bonnet, packing, packing nut, and instructions.

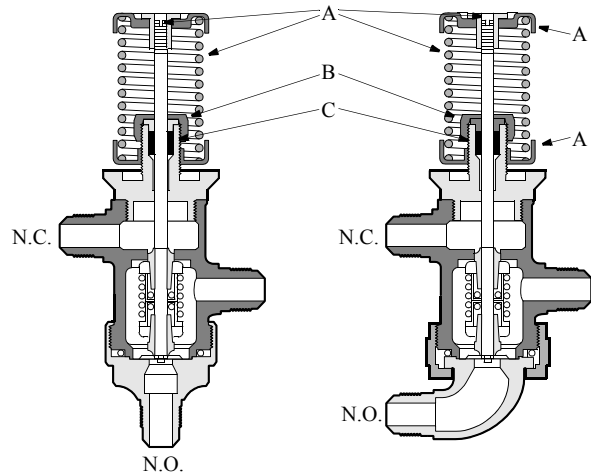

Repair Parts, V-4334



WARNING

This product is made of copper alloy, which contains lead. The product is therefore not to be used on drinking water.



WARNING

This product can expose you to chemicals including lead, which is known to the State of California to cause cancer, birth defects, or other reproductive harm. For more information, go to www.P65Warnings.ca.gov.

WARNING: BRASS MAY CONTAIN LEAD

To fulfill our obligations towards Article 33, in accordance to the European REACH Regulation No 1907/2006 EC, we hereby inform you that this article contains the following Substances of Very High Concern mentioned on the Candidate list:

- Lead

Repair Parts for Use with V-4440 Water Valve 1/2 and 5/8 in. for Three- and Four-Pipe Systems

Description

The available service parts listed in the Selection Chart can extend the service life of the V-4440 Flare Valve Assemblies and in many cases return the valve to near original operating performance.

Selection Chart

Code Number	Call-out	Description			
V-3752-646	A	Gland Nut			
V-9999-608	B	Ring Pack Packing Kits	Single pack		
V-9999-610			10 pack (contains enough material to repack 10 valves)		
V-9999-630	C	Main Springs	50 pack (contains U-cups and O-rings only to repack 50 valves)		
			Valve Size, in.	Spring Range, psig	
V-4440-6001			1/2	6 to 9	
V-4440-6002			1/2	4 to 12	
V-4440-6001			5/8	6 to 9	
V-4440-6002	5/8	4 to 12			
		Reconditioning Kits ¹	Valve Size, in.	Spring Range, psig	Cv
V-4440-6003			1/2	4 to 12	1.4
V-4440-6004					2.4
V-4440-6005				6 to 9	2.4

1. Reconditioning kit includes cage, O-ring, plug, stem, bonnet, packing, packing nut, and instructions.

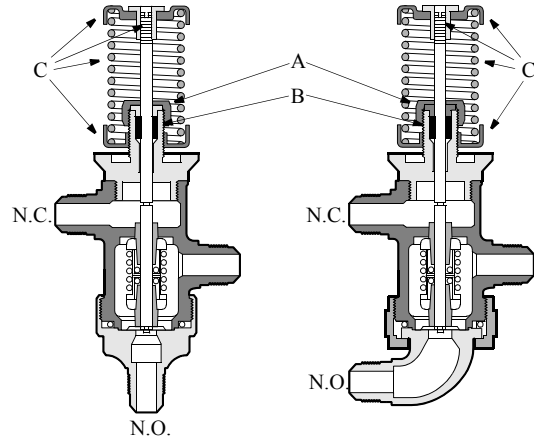

Repair Parts, V-4440
 N.O. = Normally Open N.C. = Normally Closed



WARNING This product is made of copper alloy, which contains lead. The product is therefore not to be used on drinking water.



WARNING This product can expose you to chemicals including lead, which is known to the State of California to cause cancer, birth defects, or other reproductive harm. For more information, go to www.P65Warnings.ca.gov.

WARNING: BRASS MAY CONTAIN LEAD

To fulfill our obligations towards Article 33, in accordance to the European REACH Regulation No 1907/2006 EC, we hereby inform you that this article contains the following Substances of Very High Concern mentioned on the Candidate list:

- Lead

Repair Parts for Cage Trim Valve for Use with V-3754 with Actuator and VB-3754 without Actuator (Including 1/2 in.)

Description

The available service parts listed in the Selection Charts can extend the service life of the V-3754 and VB-3754 Cage Trim Valve Assemblies and in many cases return the valve to near original operating performance.

Selection Charts

Note: 1/2 in. valve assemblies discontinued in 1991.
 VB valves used with AV-8050, AV-8051, AV-8052, AV-8090, AV-8091, and AV-8092 assemblies.
 Springs are under compression.
 Removal of springs requires use of spring compression tool JC 5389.

Repair Parts for Cage Trim Valve for Use with V-3754 with Actuator and VB-3754 without Actuator (Including 1/2 in.)

Code Number	Callout	Description	V-3754	VB-3754
V-3752-646	A	Gland Nut (Packing Nut)	■	■
V-9999-608	B	Ring Pack Packing Kits	■	■
V-9999-610		Single pack	■	■
V-9999-630		10 pack (contains enough material to repack 10 valves)	■	■
		50 pack (contains U-cups and O-rings only to repack 50 valves)	■	■

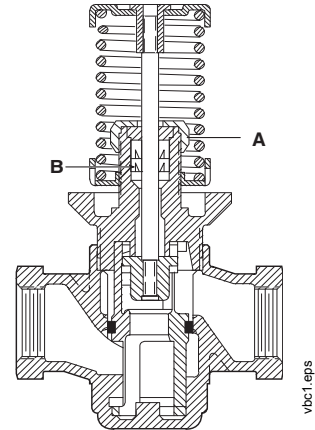

Repair Parts, V-3754 and VB-3754

Spring Kits and Reconditioning Kits for Use with V-3754 and VB-3754

Valve	Valve Size, in.	Actuator Size	Spring Range, psig	Spring Kit s ¹	Reconditioning Kits ²
V-3754	1/2	V-3000	3 to 6	V-3754-6010	V-3754-6003 (Cv = 0.20), or V-3754-6004 (Cv = 0.40) or V-3754-6005 (Cv = 1.20), or V-3754-6006 (Cv = 2.20) or V-3754-6007 (Cv = 4.40)
			9 to 13	V-3754-6009	
	3/4		3 to 6	V-3754-6010	V-3754-6001 (Cv = 8.6)
			9 to 13	V-3754-6009	
	1		3 to 6	V-3754-6011	V-3754-6002 (Cv = 13.9)
			9 to 13	V-3754-6008	
	1-1/2		3 to 6	V-3754-6011	V-5254-6001 (Cv = 27.5)
			9 to 13	V-3754-6008	

1. Spring kit includes upper and lower spring plate, spring, stem connector, stem lock screw, and instructions.
2. Reconditioning kit includes cage, O-ring, plug, stem, bonnet, packing, packing nut, and instructions.

Repair Parts for Use with V-4324 with Actuator and VB-4324 without Actuator (Including 1/2 in.)

Description

The available service parts listed in the Selection Charts can extend the service life of the V-4324 and VB-4324 Cage Trim Valve Assemblies and in many cases return the valve to near original operating performance.

Selection Charts

Note: 1/2 in. valve assemblies discontinued in 1991.
 VB valves used with AV-8050, AV-8051, AV-8052, AV-8090, AV-8091, and AV-8092 assemblies.
 Springs are under compression.
 Removal of springs requires use of spring compression tool JC 5389.

Repair Parts for Use with V-4324 with Actuator and VB-4324 without Actuator (Including 1/2 in.)

Code Number	Callout	Description	V-4324	VB-4324
V-3752-646	A	Gland Nut (Packing Nut)	■	■
V-9999-608	B	Ring Pack	■	■
V-9999-610		Packing Kits	■	■
V-9999-630			■	■

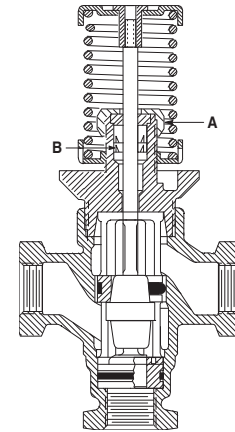

Repair Parts, V-4324 and VB-4324

Spring Kits and Reconditioning Kits for V-4324 and VB-4324

Valve	Valve Size, in.	Actuator Size	Spring Range, psig	Spring Kits ¹	Reconditioning Kits ²
V-4324	1/2	V-3000	4 to 8	V-3974-6008	V-4324-6003 (Cv = 1.20), or V-4324-6004 (Cv = 2.20), or V-4324-6005 (Cv = 4.40)
			9 to 13	V-3754-6009	
	3/4		4 to 8	V-3974-6008	V-4324-6001 (Cv = 8.6)
			9 to 13	V-3754-6009	
	1		4 to 8	V-3974-6009	V-4324-6002 (Cv = 13.9)
			9 to 13	V-3754-6008	
	1-1/2	4 to 8	V-3974-6009	V-5844-6001 (Cv = 27.5)	
		9 to 13	V-3754-6008		

1. Spring kit includes upper and lower spring plate, spring, stem connector, stem lock screw, and instructions.
2. Reconditioning kit includes cage, O-ring, plug, stem, bonnet, packing, packing nut, and instructions.

Repair Parts for Use with V-3854 with Oval Top Actuator

Description

The available packing kits and spring kits can extend the service life of the V-3854 Series valves. No inner valve kits are available for this series of valves.

Selection Charts

Repair Parts for Use with V-3854 with Oval Top Actuator

Code Number	Callout	Description
V-3802-1	A	Oval Actuator
V-3800-660	B	Packing Nut
V-9999-608	C	Ring Pack
V-9999-610		Single pack
V-9999-630		10 pack (contains enough material to repack 10 valves)
V-3100-611	D	Diaphragm

Spring Kits for Use with V-3854 with Oval Top Actuator

Valve	Valve Size, in.	Actuator Size	Spring Range, psig	Spring Kits ¹
V-3854	1/2	V-3802	3 to 6	V-3754-6012
			9 to 13	V-3754-6013

1. Spring kit includes upper spring seat, spring, stem extension, lock screw, and installation instructions.

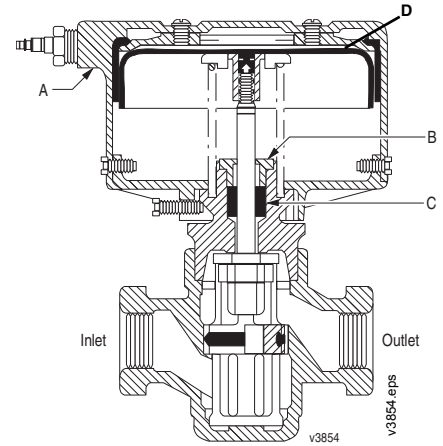

**Repair Parts,
V-3854 with Oval Top Actuator**

Repair Parts for Use with V-5254, V-5464, and V-5844 with V-5252 Size 4R Actuators

Description

The available service parts listed in the Selection Charts can extend the service life of the V-5254, V-5464, and V-5844 Series Cage Trim Valve Assemblies and in some cases return the valve to near original operating performance.

Selection Charts

Repair Parts for V-5254 with V-5252 Size 4R Actuators

Code Number	Callout	Description
V-3752-646	A	Packing Nut
V-9999-608	B	Ring Pack
V-9999-610		Packing Kits
V-9999-630		
V-5254-6001	C	Reconditioning Kit ¹

1. Reconditioning kit includes cage, nut, plug, disc, O-ring, stem, bonnet, packing, packing nut, and instructions.

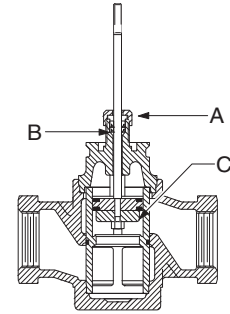

Repair Parts, V-5254

Repair Parts for V-5464 with V-5252 Size 4R Actuators

Code Number	Callout	Description
V-3752-646	A	Packing Nut
V-9999-608	B	Ring Pack
V-9999-610		Packing Kits
V-9999-630		
V-5464-6001	C	Reconditioning Kit ¹

1. Reconditioning kit includes cage, nut, plug, disc, O-ring, stem, bonnet, packing, packing nut, and instructions.

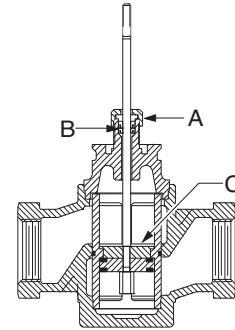

Repair Parts, V-5464

Repair Parts for V-5844 with V-5252 Size 4R Actuators

Code Number	Callout	Description
V-3752-646	A	Packing Nut
V-9999-608	B	Ring Pack
V-9999-610		Packing Kits
V-9999-630		
V-5844-6001	C	Reconditioning Kit ¹

1. Reconditioning kit includes cage, nut, plug, disc, O-ring, stem, bonnet, packing, packing nut, and instructions.

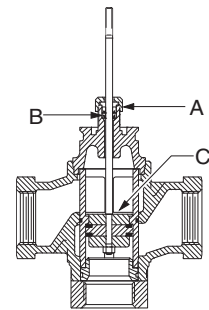

Repair Parts, V-5844

Repair Parts for Use with V-3974 with Actuator and VB-3974 without Actuator (Including 1/2 in.)

Description

The available service parts listed in the Selection Charts can extend the service life of the V-3974 and VB-3974 Cage Trim Valve Assemblies and in many cases return the valve to near original operating performance.

Note: 1/2 in. valve assemblies discontinued in 1991.
 VB valves are used with AV-8050, AV-8051, AV-8052, AV-8090, AV-8091, and AV-8092 assemblies.
 Springs are under compression.
 Removal of springs requires use of spring compression tool JC 5389.

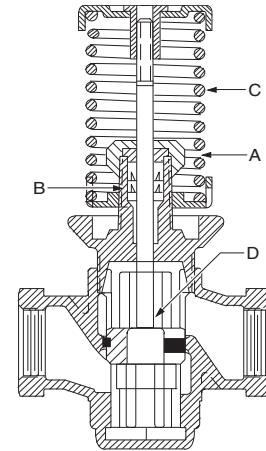

Repair Parts, V-3974 and VB-3974

Selection Charts

Repair Parts for Use with V-3974 with Actuator and VB-3974 without Actuator (Including 1/2 in.)

Code Number	Callout	Description	V-3974	VB-3974
V-3752-646	A	Gland Nut (Packing Nut)	■	■
V-9999-608	B	Ring Pack	■	■
V-9999-610		Packing Kits	■	■
V-9999-630			■	■

Spring Kits and Reconditioning Kits for V-3974 and VB-3974

Valve	Valve Size, in.	Actuator	Spring Range, psig	Spring Kits ¹ (Callout C)	Reconditioning Kits ² (Callout D)
V-3974	1/2 and 3/4	V-3000	4 to 8	V-3974-6008	1/2 in.: V-3974-6003 (Cv = 0.2) or -6004 (Cv = 0.4) or -6005 (Cv = 1.2) or -6006 (Cv = 2.2) or -6007 (Cv = 4.4)
			9 to 13	V-3754-6009	3/4 in.: V-3974-6001 (Cv = 8.6)
	1 and 1-1/2	V-3000	4 to 8	V-3974-6009	1 in.: V-3974-6002 (Cv = 13.9)
			9 to 13	V-3754-6008	1-1/2 in.: V-5464-6001 (Cv = 27.5)

1. Spring kit includes spring, upper and lower spring seat, stem extension, stem lock screw, and instructions.
2. Reconditioning kit includes cage, O-ring, plug, stem, bonnet, packing, packing nut, and instructions.

Repairs Parts for Cast Iron Flanged Globe Valves (2-1/2 through 6 in.) for Use with V-5252 and VB-3752

Description

The available repair parts listed in the Selection Charts can extend the service life of the V-5252 and VB-3752 Series Cast Iron Flanged Globe Valves and return the valves to near original operating performance.

Selection Charts

Repair Parts for Cast Iron Flanged Globe Valves (2-1/2 through 6 in.) for Use with V-5252 and VB-3752

Code Number	Callout	Description	Valve Size, in.	Actuator Size	Type of Packing
V-9999-613	A	Packing Kits	2-1/2 through 4	(VB-3752)	EPDM Ring Pack
			1-1/2 through 4	4R and 5R	EPDM Ring Pack
			4 through 6	8R	EPDM Ring Pack
V-4510-6019	B	Packing Nuts	2-1/2 through 3	4R	3/8
			2-1/2 through 4	5R	3/8
			4 through 6	8R	1/2
V-4710-6010 V-4710-6011 V-4710-6013 V-4710-6014 V-4710-6015	C	Disc Only	2	1-1/2	
			2-1/2	2-1/2	
			3	3	
			4	4	
			5	5	
			6	6	

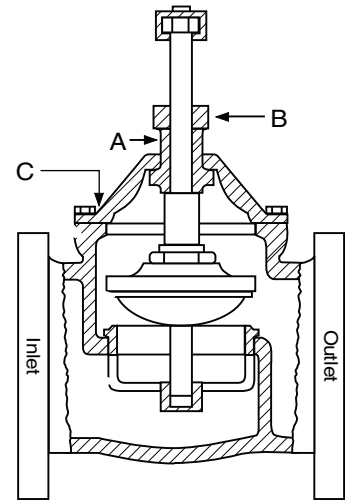

Repair Parts for Use with V-5252 and VB-3752

vb3752.eps

Reconditioning Kits for V-5252 and VB-3752

Code Number	Valve Size, in.	Actuator	Reconditioning Kits ¹
V-5252	2-1/2	4R or 5R	V-5252-6001 5R or V-5252-6002 4R
	3	4R or 5R	V-5252-6003 5R or V-5252-6004 4R
	4	5R or 8R	V-5252-6005 5R or V-5252-6006 8R
	5	8R	V-5252-6007
	6	8R	V-5252-6008

1. Reconditioning kit includes stem, packing nut, follower, packing box, packing, bonnet, gasket, swivel, pins, disc holder, screws, disc retainer, disc, spacer, guide rod, swivel nut, packing spacer, packing tools, and instructions.



WARNING

This product is made of copper alloy, which contains lead. The product is therefore not to be used on drinking water.



WARNING

This product can expose you to chemicals including lead, which is known to the State of California to cause cancer, birth defects, or other reproductive harm. For more information, go to www.P65Warnings.ca.gov.

WARNING: BRASS MAY CONTAIN LEAD

To fulfill our obligations towards Article 33, in accordance to the European REACH Regulation No 1907/2006 EC, we hereby inform you that this article contains the following Substances of Very High Concern mentioned on the Candidate list:

- Lead

Repairs Parts for Cast Iron Flanged Globe Valves (2-1/2 through 6 in.) for Use with V-5462 and VB-3970

Description

The available parts listed in the Selection Charts can extend the service life of the V-5462 and VB-3970 Series Cast Iron Globe Valves and return the valves to near original operating performance.

Selection Charts

Repair Parts for Cast Iron Flanged Globe Valves (2-1/2 through 6 in.) for Use with V-5462 and VB-3970

Code Number	Callout	Description			
	A	Packing Kits	Valve Size, in.	Actuator Size	Type of Packing
V-9999-613			2-1/2 through 4	(VB-3790)	EPDM Ring Pack
V-9999-613			2-1/2 through 4	5R	EPDM Ring Pack
V-5252-668			3 through 6	8R	EPDM Ring Pack
	B	Packing Nuts	Actuator Size	Valve Size, in.	Stem Diameter, in.
V-4510-6019			5R	2-1/2 through 4	3/8
V-5252-609			8R	4 through 6	1/2
	C	Disc Only	Valve Size, in.		
V-3011-6002			1-1/4		
V-3020-6006			1-1/2		
V-3020-6007			2		
V-4710-6010			2-1/2		
V-4710-6011			3		
V-4710-6013			4		
V-4710-6014			5		
V-4710-6015			6		

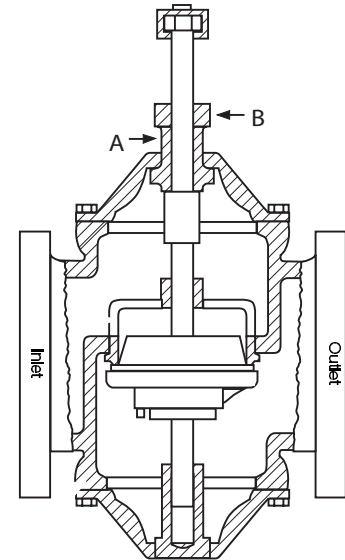

Repair Parts for Use with V-5462 and VB-3970

Reconditioning Kits for V-5462 and VB-3970

Code Number	Valve Size, in.	Actuator	Reconditioning Kits ¹
V-5462	2-1/2	5R	V-5462-6001
	3	5R or 8R	V-5462-6002 5R or V-5462-6003 8R
	4	5R or 8R	V-5462-6004 5R or V-5462-6005 8R
	5	8R	V-5462-6006
	6	8R	V-5462-6007

1. Reconditioning kit includes stem, packing nut, follower, packing box, packing, bonnet, gasket, swivel, pins, disc holder, screws, disc retainer, disc, spacer, packing spacer, swivel nut, spacer, packing tools, and instructions.



WARNING

This product is made of copper alloy, which contains lead. The product is therefore not to be used on drinking water.



WARNING

This product can expose you to chemicals including lead, which is known to the State of California to cause cancer, birth defects, or other reproductive harm. For more information, go to www.P65Warnings.ca.gov.

WARNING: BRASS MAY CONTAIN LEAD

To fulfill our obligations towards Article 33, in accordance to the European REACH Regulation No 1907/2006 EC, we hereby inform you that this article contains the following Substances of Very High Concern mentioned on the Candidate list:

- Lead

Repairs Parts for Cast Iron Flanged Globe Valves (2-1/2 through 6 in.) for Use with V-5842 and VB-4322

Description

The available parts listed in the Selection Charts can extend the service life of the V-5842 and VB-4322 Series Cast Iron Flanged Globe Valves and return the valves to near original operating performance.

Selection Charts

Repair Parts for Cast Iron Flanged Globe Valves (2-1/2 through 6 in.) for Use with V-5842 and VB-4322

Code Number	Callout	Description	Valve Size, in.	Actuator Size	Type of Packing
V-9999-613	A	Packing Kits	2-1/2 through 4	(VB-4322)	EPDM Ring Pack
			2-1/2 and 3	5R	EPDM Ring Pack
			3 through 6	8R	EPDM Ring Pack
Purchase Locally Quantity Required Per Valve	B	Lower Cap Screws	Valve Size, in.	Screw Size, in.	
6			2-1/2	1 x 5/16 to 18	
6			3	1 x 3/8 to 16	
8			4	1-1/4 x 3/8 to 16	
8			5	1-1/4 x 1/2 to 13	
10			6	1-1/2 x 1/2 to 13	
Purchase Locally Quantity Required Per Valve	C	Upper Cap Screws	Valve Size, in.	Screw Size, in.	
6			2-1/2	3/4 x 5/16 to 18	
6 and 8			3 and 4	7/8 x 3/8 to 16	
8 and 10			5 and 6	1 x 1/2 to 13	

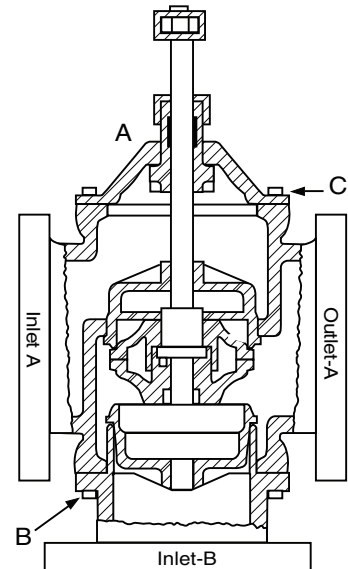

Repair Parts for Use with V-5842 and VB-4322

Reconditioning Kits for V-5842 and VB-4322

Code Number	Valve Size, in.	Actuator	Reconditioning Kits ¹
V-5842	2-1/2	5R	V-5842-6001
	3	5R or 8R	V-5842-6002 5R or V-5842-6003 8R
	4	5R or 8R	V-5842-6004 (Elect) or V-5842-6005 8R
	5	8R	V-5842-6006
	6	8R	V-5842-6007

1. Reconditioning kit includes stem, packing nut, follower, packing box, packing, bonnet, gasket, swivel, pins, disc holder, screws, lower plug, upper plug, guide rod, packing spacer, packing tools, and instructions.

WARNING	This product is made of copper alloy, which contains lead. The product is therefore not to be used on drinking water.
----------------	---

WARNING	This product can expose you to chemicals including lead, which is known to the State of California to cause cancer, birth defects, or other reproductive harm. For more information, go to www.P65Warnings.ca.gov .
----------------	---

<p>WARNING: BRASS MAY CONTAIN LEAD</p> <p>To fulfill our obligations towards Article 33, in accordance to the European REACH Regulation No 1907/2006 EC, we hereby inform you that this article contains the following Substances of Very High Concern mentioned on the Candidate list:</p> <ul style="list-style-type: none"> Lead

Repair Parts for Use with V-7216 Two-Way Normally Open Steam or Water Valve

Description

The available packing kits can extend the service life of the V-7216 Series valves. No inner valve kits are available for this series of valves.

Selection Chart

Code Number	Callout	Description			
	A	Packing Kits	Valve Size, in.		Stem Size, in.
V-9999-608 ¹			1/2 and 3/4		1/4
V-9999-613 ¹			1-1/4 through 2		3/8

1. Low-temperature use, less than or equal to 281°F (138°C)

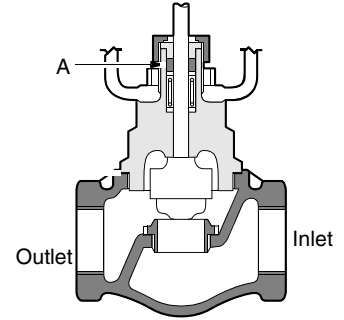

Repair Parts, V-7216

Repair Parts for Use with V-7416 Two-Way Normally Closed Steam or Water Valve

Description

The available packing kits can extend the service life of the V-7416 Series valves. No inner valve kits are available for this series of valves.

Selection Chart

Code Number	Callout	Description		
	A	Packing Kits	Valve Size, in.	Stem Size, in.
V-9999-608 ¹			1/2 and 3/4	1/4
V-5290-6840 ²			1/2 through 1	1/4
V-9999-613 ¹			1-1/4 through 2	3/8
V-5290-6841 ²				

1. Low-temperature use, less than or equal to 281°F (138°C)
2. High-temperature use, greater than 281°F (138°C)

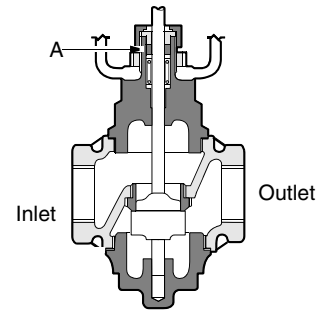

Repair Parts, V-7416

Repair Parts for Use with V-3752 Normally Open Valves

The available parts listed in the Selection Charts can extend the service life of the V-3752 Series valves and return the valves to near original operating performance.

Selection Charts

Repair Parts for Use with V-3752 Normally Open Valves 1/2 in. through 2 in.

Code Number ¹	Call-out	Description
V-9999-608	A	Packing Kit
V-3752-646	B	Packing Nut
	C	Union Nut and Male Tailpiece Assemblies for Valves with Union Connections
V-3752-636		Valve Size, in. 1/2
V-3752-637		3/4
V-3752-638		1
V-3752-639		1-1/4
	D	Stem and Swivel Assembly Includes Stem, Swivel, and Swivel Nut Lock Pin for Globe Valves
V-3752-6064		Valve Size, in. 1/2
	E	Disc Assemblies Include Disc, Disc Holder, Modulating Plug, and Three Pins for:
V-3020-6045		Globe Valves Valve Size, in. Seat Size, in. Cv 1/2 3/8 0.9
V-3020-6047		1/2 3/8 1.8
		Union Angle Valves Valve Size, in. Seat Size, in. Cv 1/2 3/8 1.1
V-3020-6045		1/2 3/8 1.1
V-3020-6047		1/2 3/8 2.5
	F	Disc Only
V-3020-6021		Valve Size, in. 1/2
V-3752-6047		3/4
V-3011-6001		1
V-3011-6002		1-1/4
	G	Union Globe Body Only
V-3752-6004		Valve Size, in. 3/4
V-3752-6005		1
	N/A	Inner Valve and Spring Assemblies for:
V-3752-6050		Globe Valves 3 to 6 psig Valve Size, in. Cv 1/2 0.9
V-3752-6051		1/2 1.8
		Union Angle Valves 3 to 6 psig Valve Size, in. Cv 1/2 2.5
V-3752-6052		1/2 2.5

1. The 1/2 in. through 2 in. size valves of this model discontinued in 1979.

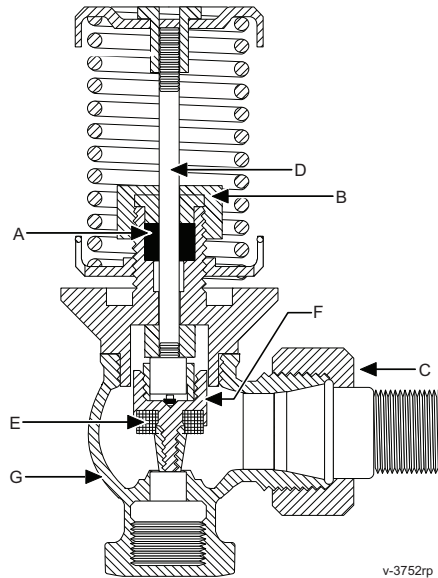

Repair Parts, V-3752

Description

Spring Kits and Reconditioning Kits for V-3752¹

Code Number	Valve Size, in.	Actuator Size	Spring Range, psig	Spring Kits ²	Reconditioning Kits ³	
V-3752	1/2	V-3000	3 to 6	V-3752-6023	V-3752-6016 (Cv = 3.7) or V-3752-6027 (Cv = 3.8)	
			9 to 13	V-3752-6022		
	3/4		3 to 6	V-3752-6023		V-3752-6017 (Cv = 7) or V-3752-6028 (Cv = 7)
			9 to 13	V-3752-6022		
	1.		3 to 6	V-3752-6024		V-3752-6018 (Cv = 12) or V-3752-6019 (Cv = 12)
			9 to 13	V-3752-6021		
	1-1/4		3 to 6	V-3752-6024		V-3752-6020 (Cv = 20) or V-3752-6030 (Cv = 20)
			9 to 13	V-3752-6021		
	1-1/2		3 to 6	V-3754-6010		V-3752-6034 (Cv = 35) or V-3752-6031 (Cv = 26)
			9 to 13	V-3754-6009		
	2		3 to 6	V-3754-6010		V-3752-6034 (Cv = 35) or V-3752-6031 (Cv = 26)
			9 to 13	V-3754-6009		

- The 1/2 in. through 2 in. size valves of this model discontinued in 1979.
- Spring kit includes spring, upper and lower spring seat, stem extension, stem lock screw, and instructions.
- Reconditioning kit includes O-ring, swivel nut, washer, disc, disc holder, contoured disc retainer, pins, swivel, spacer, stem, bonnet, packing, packing nut, and instructions, unless otherwise noted.

Repair Parts for Use with V-3755 Normally Open Valves, 1/2 through 2 in.

Description

The available parts listed in the Selection Charts can extend the service life of the V-3755 Series valves and return the valves to near original operating performance.

Selection Charts

Repair Parts for Use with V-3755 Normally Open Valves, 1/2 through 2 in.

Code Number ¹	Callout	Description	Valve Size, in.	Seat Size, in.
V-9999-608	A	Packing Kit		
V-3752-646	B	Packing Nut		
	C	Union Nut and Male Tailpiece Assemblies for Valves with Union Connections	1/2	
V-3752-636			3/4	
V-3752-637			1	
V-3752-638			1-1/4	
V-3752-639				
	D	Disc Only	1	1
V-3011-6002			1-1/4	1-1/4
V-3020-6006			1-1/2	1-1/2
V-3020-6007				

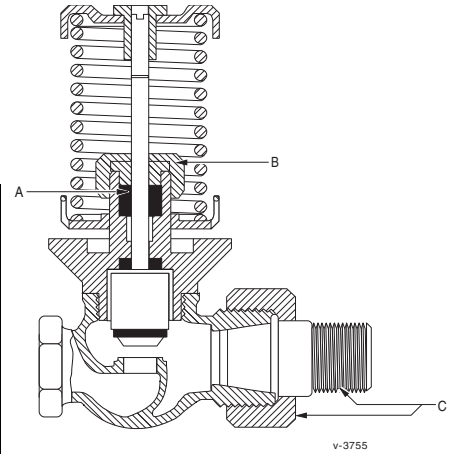

Repair Parts, V-3755

1. The V-3755 model discontinued in 1974.

Spring Kits and Reconditioning Kits for V-3755

Code Number	Valve Size, in.	Actuator Size	Spring Range, psig	Spring Kit	Reconditioning Kit ¹
V-3755	1/2	V-3000	3 to 6	V-3752-6023	V-3755-6050 (Cv = 3)
			9 to 13	V-3752-6022	No kit available, replace valve
	3/4		3 to 6	V-3752-6023	V-3755-6002 (Cv = 5.2) or V-3755-6007 (Cv = 9) or V-3755-6011 (Cv = 6) or V-3755-6017 (Cv = 9)
			9 to 13	V-3752-6022	
	1		3 to 6	V-3752-6024	V-3755-6003 (Cv = 8.2) or V-3755-6008 (Cv = 17) or V-3755-6012 (Cv = 10) or V-3755-6018 (Cv = 17)
			9 to 13	V-3752-6021	
	1-1/4		3 to 6	V-3752-6024	V-3755-6004 (Cv = 13) or V-3755-6009 (Cv = 24)
			9 to 13	V-3752-6021	
	1-1/2		3 to 6	V-3754-6010	V-3755-6005 (Cv = 21) or V-3755-6014 (Cv = 23) or V-3755-6020 (Cv = 41)
			9 to 13	V-3754-6009	
	2		3 to 6	V-3754-6010	V-3755-6015 (Cv = 35) or V-3755-6021 (Cv = 60)
			9 to 13	V-3754-6009	

1. Reconditioning kit includes O-ring, swivel nut, washer, disc retainer, disc, disc holder, pins, swivel, stem, bonnet, packing follower, packing, packing nut, and packing spacer.

Repair Parts for Use with VB-3752 Normally Open Steam and Water Valves

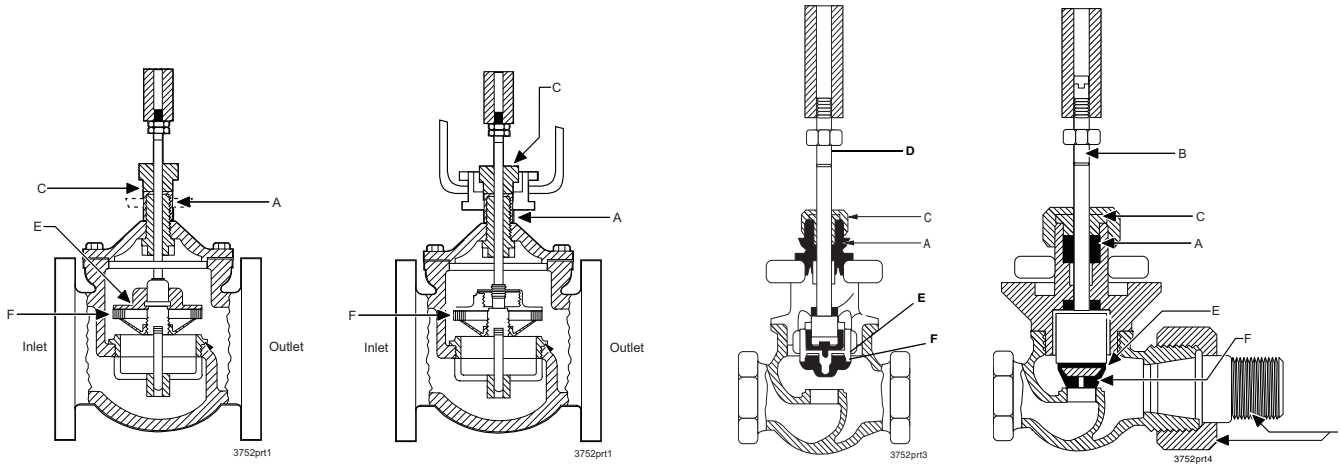

Repair Parts, VB-3752

Description

The available service parts listed in the Selection Chart can extend the service life of the VB-3752 Series valves and in many cases return the valve to near original operating performance.

Selection Chart

Code Number	Call-out	Description			
	A	Packing for Use with both Water and Steam	Valve Size, in.	Valve Shipping Date	Stem Diameter, in.
V-9999-608			1/2 to 1-1/4	All	1/4
V-9999-608			1-1/2 and 2	After 1-1-68	1/4
V-5460-602			1-1/2 and 2	Before 1-1-68	5/16
V-5460-602			2-1/2 to 4 (VA-3200)	All	5/16
V-5280-602			2-1/2 to 8 (VA-3400)	All	1/2
	B	Union Nut and Male Tailpiece Assemblies for Valves with Union Connections	Valve Size, in.		
V-3752-636			1/2		
V-3752-637			3/4		
V-3752-638			1		
V-3752-639			1-1/4		
	C	Gland Nut	Valve Size, in.	Valve Shipping Date	Actuator
V-3752-646			1/2 to 1-1/4	All	VA-3200 VA-5000
V-3752-646			1-1/2 and 2	After 1-1-68	VA-3200 VA-5000
V-4510-6019			1-1/2 and 2	Before 1-1-68	VA-3200 VA-5000
V-4510-6019			2-1/2 to 4	All	VA-3200
V-4510-6020			2-1/2 to 8	All	VA-3400
			D	Stem and Swivel Assemblies Include Stem, Swivel, and Pins for:	Valves Shipped after 3-1-69
V-3752-6064					1/2

Code Number	Call-out	Description			
	E	Disc Assemblies Include Disc, Disc Holder, Modulating Plug, and Pin	Globe Valves	Valve Size, in.	Cv
V-3020-6045			1/2	0.9	
V-3020-6047			1/2	1.8	
			Union Angle Valves	Valve Size, in.	Cv
V-3020-6045			1/2	0.9	
V-3020-6047	1/2	2.5			
	F	Disc Only	Valve Size, in.	Seat Size, in.	
V-3020-6021			1/2	3/8	
V-3752-6047			3/4	1/2	
V-3011-6001			1	3/4	
V-3011-6002			1-1/4	1	
V-3020-6006			1-1/2	1-1/4	
V-3020-6007			2	1-1/2	
V-4710-6010			2-1/2		
V-4710-6011			3		
V-4710-6013			4		
V-4710-6014			5		
V-4710-6015			6		

Repair Parts For Use with V-3800 Normally Open Valves 1/2 and 3/4 in.

Description

The available service parts listed in the Selection Chart can extend the service life of the V-3800 Series valves. No inner valve kits are available for this series of valves.

Selection Chart

Code Number ¹	Callout	Description	
V-3802-1	A	Oval Actuator Complete	
V-9999-608	B	Packing Ring Pack	
	C	Union Nut and Tailpiece Assemblies for Valves with Union Connections	Valve Size, in.
V-3752-636			1/2
V-3752-637			3/4
V-3100-611	D	Diaphragm for Oval Top Actuators	

1. The V-3800 model discontinued in 1978.

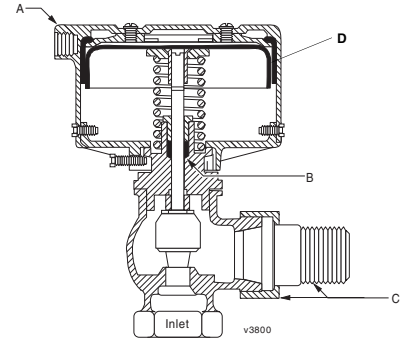

Repair Parts, V-3800

Repair Parts for Use with V-5210 High-Pressure Normally Open Valve 2-1/2 through 4 in. Cast Iron 250 lb ANSI Raised Flanges

Description

The repair parts available for the V-5210 Series valves are limited to the parts in the Selection Chart.

Selection Chart

Code Number	Callout	Description		
V-5290-6842 ¹	A	Packing Kit includes PTFE V-rings for 2-1/2 through 4 in. valves		
V-4530-650 ²		Packing Kits		
V-9999-608 ²				
V-4710-602	B	Diaphragms	V-3000 and 4R	Steam valves
V-4710-603			V-3000 and 4R	Water valves
V-4710-604			4R	
			5R	
			8R	

1. For valves shipped after June 1982
2. For valves shipped before June 1982

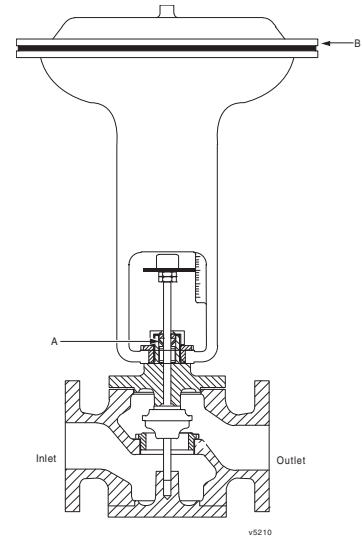

Repair Parts, V-5210

Repair Parts for Use with V-5410 High-Pressure Normally Closed Valves 2-1/2 through 4 in. Cast Iron 250 lb ANSI Raised Flanges

Description

The repair parts available for the V-5410 Series valves are limited to the parts in the Selection Chart.

Selection Chart

Code Number ¹	Callout	Description		
V-4530-650 ²	A	Package Kits	V-3000, 4R	Steam valves
V-9999-608 ²			V-3000, 4R	Water valves
V-4710-602	B	Diaphragms	4R	
V-4710-603			5R	
V-9999-613				
V-4710-604 V-9999-613			8R	

1. The V-5410 model discontinued in 1993.
2. For valves shipped before June 1982

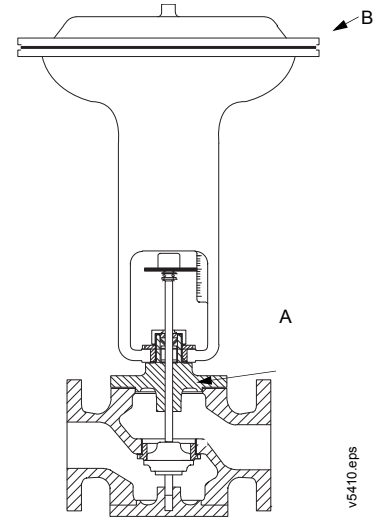

Repair Parts, V-5410

Valve Spring Kits Sorted by Valve Code Number

Description

Available replacement actuators and spring kits can extend the service life of many Johnson Controls® valves.

Selection Chart

Valve Body	Valve Size, in.	Spring Range, psig	Actuator	Spring Kit Code Number
V-3011	1 and 1-1/4	3 to 6	V-3000-1 or V-3000-2	V-3752-6024
V-3011	1 and 1-1/4	9 to 13	V-3000-1 or V-3000-2	V-3752-6021
V-3011	1-1/2 to 2	3 to 6	V-3000-1 or V-3000-2	V-3754-6010
V-3011	1-1/2 to 2	9 to 13	V-3000-1 or V-3000-2	V-3754-6009
V-3011	1/2 and 3/4	3 to 6	V-3000-1 or V-3000-2	V-3752-6023
V-3011	1/2 and 3/4	9 to 13	V-3000-1 or V-3000-2	V-3752-6022
V-3020	1 and 1-1/4	3 to 6	V-3000-1 or V-3000-2	V-3752-6024
V-3020	1 and 1-1/4	9 to 13	V-3000-1 or V-3000-2	V-3752-6021
V-3020	1-1/2 to 2	3 to 6	V-3000-1 or V-3000-2	V-3754-6010
V-3020	1-1/2 to 2	9 to 13	V-3000-1 or V-3000-2	V-3754-6009
V-3020	1/2 and 3/4	3 to 6	V-3000-1 or V-3000-2	V-3752-6023
V-3020	1/2 and 3/4	9 to 13	V-3000-1 or V-3000-2	V-3752-6022
V-3100	1/2 and 3/4	3 to 6	V-3802 or V-4000	V-3800-6002
V-3100	1/2 and 3/4	9 to 13	V-3802 or V-4000	V-3800-6003
V-3212	1 and 1-1/4	4 to 8	V-3000-1 or V-3000-2	V-4322-6001
V-3212	1 and 1-1/4	9 to 13	V-3000-1 or V-3000-2	V-3752-6021
V-3212	1-1/2 to 2	4 to 8	V-3000-1 or V-3000-2	V-3974-6008
V-3212	1-1/2 to 2	9 to 13	V-3000-1 or V-3000-2	V-3754-6009
V-3212	1/2 and 3/4	4 to 8	V-3000-1 or V-3000-2	V-4332-6001
V-3212	1/2 and 3/4	9 to 13	V-3000-1 or V-3000-2	V-3752-6022
V-3752	1 and 1-1/4	3 to 6	V-3000-1 or V-3000-2	V-3752-6024
V-3752	1 and 1-1/4	9 to 13	V-3000-1 or V-3000-2	V-3752-6021
V-3752	1-1/2 to 2	3 to 6	V-3000-1 or V-3000-2	V-3754-6010
V-3752	1-1/2 to 2	9 to 13	V-3000-1 or V-3000-2	V-3754-6009
V-3752	1/2 and 3/4	3 to 6	V-3000-1 or V-3000-2	V-3752-6023
V-3752	1/2 and 3/4	9 to 13	V-3000-1 or V-3000-2	V-3752-6022
V-3754	1 and 1-1/2	3 to 6	V-3000-1 or V-3000-2	V-3754-6011
V-3754	1 and 1-1/2	9 to 13	V-3000-1 or V-3000-2	V-3754-6008
V-3754	1/2 and 3/4	3 to 6	V-3000-1 or V-3000-2	V-3754-6010
V-3754	1/2 and 3/4	9 to 13	V-3000-1 or V-3000-2	V-3754-6009
V-3755	1 and 1-1/4	3 to 6	V-3000-1 or V-3000-2	V-3752-6024
V-3755	1 and 1-1/4	9 to 13	V-3000-1 or V-3000-2	V-3752-6021
V-3755	1-1/2 to 2	3 to 6	V-3000-1 or V-3000-2	V-3754-6010
V-3755	1-1/2 to 2	9 to 13	V-3000-1 or V-3000-2	V-3754-6009
V-3755	1/2 and 3/4	3 to 6	V-3000-1 or V-3000-2	V-3752-6023
V-3755	1/2 and 3/4	9 to 13	V-3000-1 or V-3000-2	V-3752-6022
V-3766	1/2	3 to 6	V-3000-1 or V-3000-2	V-3754-6010
V-3800	1/2 and 3/4	3 to 6	V-3802 or V-4000	V-3800-6002
V-3800	1/2 and 3/4	9 to 13	V-3802 or V-4000	V-3800-6003
V-3854	1/2	3 to 6	V-3802 or V-4000	V-3754-6012
V-3854	1/2	9 to 13	V-3802 or V-4000	V-3754-6013
V-3964	1/2	9 to 13	V-3000-1 or V-3000-2	V-3754-6009
V-3966	1/2	9 to 13	V-3000-1 or V-3000-2	V-3754-6009
V-3970	1 and 1-1/4	4 to 8	V-3000-1 or V-3000-2	V-4322-6001
V-3970	1 and 1-1/4	9 to 13	V-3000-1 or V-3000-2	V-3752-6021
V-3970	1-1/2 to 2	4 to 8	V-3000-1 or V-3000-2	V-3974-6008
V-3970	1-1/2 to 2	9 to 13	V-3000-1 or V-3000-2	V-3754-6009

Valve Body	Valve Size, in.	Spring Range, psig	Actuator	Spring Kit Code Number
V-3970	1/2 and 3/4	4 to 8	V-3000-1 or V-3000-2	V-4332-6001
V-3970	1/2 and 3/4	9 to 13	V-3000-1 or V-3000-2	V-3752-6022
V-3974	1 and 1-1/2	4 to 8	V-3000-1 or V-3000-2	V-3974-6009
V-3974	1 and 1-1/2	9 to 13	V-3000-1 or V-3000-2	V-3754-6008
V-3974	1/2 and 3/4	4 to 8	V-3000-1 or V-3000-2	V-3974-6008
V-3974	1/2 and 3/4	9 to 13	V-3000-1 or V-3000-2	V-3754-6009
V-4322	1 and 1-1/4	4 to 8	V-3000-1 or V-3000-2	V-4322-6001
V-4322	1 and 1-1/4	9 to 13	V-3000-1 or V-3000-2	V-3752-6021
V-4322	1-1/2 to 2	4 to 8	V-3000-1 or V-3000-2	V-3974-6008
V-4322	1-1/2 to 2	9 to 13	V-3000-1 or V-3000-2	V-3754-6009
V-4322	1/2 and 3/4	4 to 8	V-3000-1 or V-3000-2	V-4332-6001
V-4322	1/2 and 3/4	9 to 13	V-3000-1 or V-3000-2	V-3752-6022
V-4324	1 and 1-1/2	4 to 8	V-3000-1 or V-3000-2	V-3974-6009
V-4324	1 and 1-1/2	9 to 13	V-3000-1 or V-3000-2	V-3754-6008
V-4324	1/2 and 3/4	4 to 8	V-3000-1 or V-3000-2	V-3974-6008
V-4324	1/2 and 3/4	9 to 13	V-3000-1 or V-3000-2	V-3754-6009
V-4332	1/2	4 to 8	V-3000-1 or V-3000-2	V-4332-6001
V-4332	1/2	9 to 13	V-3000-1 or V-3000-2	V-3752-6022
V-4333	1/2	4 to 8	V-3000-1 or V-3000-2	V-4332-6001
V-4333	1/2	9 to 13	V-3000-1 or V-3000-2	V-3752-6022
V-4334	1/2	4 to 8	V-3000-1 or V-3000-2	V-4332-6001
V-4334	1/2	9 to 13	V-3000-1 or V-3000-2	V-3752-6022
V-4440	1/2	4 to 12	V-3000-1 or V-3000-2	V-4440-6002
V-4440	5/8	4 to 12	V-3000-1 or V-3000-2	V-4440-6002
V-4440	1/2 and 5/8	6 to 9	V-3000-1 or V-3000-2	V-4440-6001
V-4510	1 and 1-1/4	3 to 6	V-3000-1 or V-3000-2	V-3752-6024
V-4510	1-1/2 to 2	3 to 6	V-3000-1 or V-3000-2	V-3754-6010
V-4510	1/2 and 3/4	3 to 6	V-3000-1 or V-3000-2	V-3752-6023
V-5216	1/2	3 to 6	V-3000-1 or V-3000-2	V-3752-6023
V-5216	3/4	3 to 6	V-3000-1 or V-3000-2	V-3752-6024
V-5230	1	3 to 7	V-3000-1 or V-3000-2	V-5230-6002
V-5230	1/2 and 3/4	3 to 7	V-3000-1 or V-3000-2	V-5230-6001
V-5250	1 and 1-1/4	3 to 6	V-3000-1 or V-3000-2	V-3752-6024
V-5250	1-1/2 - 2	3 to 6	V-3000-1 or V-3000-2	V-3754-6010
V-5250	1/2 and 3/4	3 to 6	V-3000-1 or V-3000-2	V-3752-6023
V-5416	1/2	9 to 13	V-3000-1 or V-3000-2	V-3752-6022
V-5416	3/4	9 to 13	V-3000-1 or V-3000-2	V-3752-6021
V-5430	1/2 and 3/4	9 to 14	V-3000-1 or V-3000-2	V-5430-6001
V-6139	1/2	9 to 13	V-3000-1 or V-3000-2	V-3754-6009
V-6143	3/8 and 3/4	9 to 13	V-3000-1 or V-3000-2	V-3752-6022
V-7216	1/2	3 to 6	V-3000-1 or V-3000-2	V-3752-6023
V-7216	3/4	3 to 6	V-3000-1 or V-3000-2	V-3752-6024
V-7416	1/2	9 to 13	V-3000-1 or V-3000-2	V-3752-6022
V-7416	3/4	9 to 13	V-3000-1 or V-3000-2	V-3752-6021

Valve Spring Kits Sorted by Valve Code Number (Continued)

Valve Body	Valve Size, in.	Spring Range, psig	Actuator	Spring Kit Code Number
VG7000	1/2 or 3/4	3 to 6	V-3000-8001, V-3000-8003, V-3000-8011, or V-3000-8012	VG7000-1001
VG7000	1/2 or 3/4	3 to 6	V-3801-8001	VG7000-1010
VG7000	1/2 or 3/4	4 to 8	V-3000-8001, V-3000-8003, V-3000-8011, or V-3000-8012	VG7000-1002
VG7000	1/2 or 3/4	4 to 8	V-3801-8001	VG7000-1011
VG7000	1/2 or 3/4	9 to 13	V-3000-8001, V-3000-8003, V-3000-8011, or V-3000-8012	VG7000-1003
VG7000	1/2 or 3/4	9 to 13	V-3801-8001	VG7000-1012
VG7000	1/2 or 3/4	Spring Kit with Three Springs ¹	V-3801-8001	VG7000-1015
VG7000	1 or 1-1/4	3 to 6	V-3000-8001, V-3000-8003, V-3000-8011, or V-3000-8012	VG7000-1004
VG7000	1 or 1-1/4	4 to 8	V-3000-8001, V-3000-8003, V-3000-8011, or V-3000-8012	VG7000-1005
VG7000	1 or 1-1/4	9 to 13	V-3000-8001, V-3000-8003, V-3000-8011, or V-3000-8012	VG7000-1006
VG7000	1-1/2 or 2	3 to 6	V-3000-8001, V-3000-8003, V-3000-8011, or V-3000-8012	VG7000-1007
VG7000	1-1/2 or 2	4 to 8	V-3000-8001, V-3000-8003, V-3000-8011, or V-3000-8012	VG7000-1008
VG7000	1-1/2 or 2	9 to 13	V-3000-8001, V-3000-8003, V-3000-8011, or V-3000-8012	VG7000-1009
VG7000	1, 1-1/4, 1-1/2, or 2	N/A	V-400	VG7000-1014
VT Series	1/2	3 to 6	V-3802 or V-4000	V-9999-6001
	1/2	4 to 8	V-3802 or V-4000	V-9999-6002
	1/2	9 to 13	V-3802 or V-4000	V-9999-6003
VT Series (All)	1/2	3 to 6	V-3000-1 or V-3000-2	V-3752-6023
	1/2	4 to 8	V-3000-1 or V-3000-2	V-4332-6001
	1/2	9 to 13	V-3000-1 or V-3000-2	V-3752-6022

1. Spring kit with three springs: 3 to 6, 4 to 8, and 9 to 13 (includes hardware to adapt one valve only)

Inner Valve Reconditioning Kits: 1/2 to 5/8 in.

Description

The Selection Chart provides repair recommendations for older series of Johnson Controls® 1/2 in. through 5/8 in. valves. Available inner valve kits can extend the service life of many Johnson Controls valves, while others require valve replacement to maintain system performance.

Note: For VG7000 Reconditioning Kits, refer to the *VG7000 Series Bronze Globe Valves, Maintenance and Repair Catalog Page (LIT-1924275)*.

Selection Chart

Valve Body	Valve Size, in.	Spring Range, psig	Inner Valve Kit Code Number
V-3011	1/2	3 to 6 or 9 to 13	No kits available, replace valve
V-3020	1/2	3 to 6 or 9 to 13	No kits available, replace valve
V-3100	1/2	3 to 6 or 9 to 13	No kits available, replace valve
V-3212	1/2	4 to 8 or 9 to 13	V-3970-6003 or V-3970-6004
V-3752	1/2	3 to 6 or 9 to 13	V-3752-6050 , V-3752-6051 , or V-3752-6052
V-3755	1/2	3 to 6 or 9 to 13	No kits available, replace valve
V-3766	1/2	3 to 6	No kits available, replace valve
V-3800	1/2	3 to 6 or 9 to 13	V-3800-6050 or V-3800-6051
V-3854	1/2	3 to 6 or 9 to 13	V-3854-6051 or V-3854-6052
V-3964	1/2	9 to 13	No kits available, replace valve
V-3966	1/2	9 to 13	No kits available, replace valve
V-3970	1/2	4 to 8	V-3970-6003 or V-3970-6004
V-3974	1/2	4 to 8 or 9 to 13	V-3974-6003 , V-3974-6004 , V-3974-6005 , V-3974-6006 , or V-3974-6007
V-4322	1/2	4 to 8 or 9 to 13	V-4322-6004
V-4332	1/2	4 to 8 or 9 to 13	No kits available, replace valve
V-4333	1/2	4 to 8 or 9 to 13	No kits available, replace valve
V-4334	5/8	4 to 8 or 9 to 13	No kits available, replace valve
V-4440	1/2	4 to 12	V-4440-6003 or V-4440-6004
V-4440	1/2	6 to 9	V-4440-6005
V-4440	5/8	4 to 12 or 6 to 9	No kits available, replace valve
V-4510	1/2	3 to 6	No kits available, replace valve
V-5216	1/2	3 to 6	No kits available, replace valve
V-5230	1/2	3 to 7	No kits available, replace valve
V-5416	1/2	9 to 13	No kits available, replace valve
V-5430	1/2	9 to 14	No kits available, replace valve
V-6139	1/2	9 to 13	No kits available, replace valve
V-7216	1/2	3 to 6	No kits available, replace valve
V-7416	1/2	9 to 13	No kits available, replace valve
VT Series	1/2	3 to 6, 4 to 8, or 9 to 13	No kits available, replace valve

Inner Valve Reconditioning Kits: 3/4 to 2 in.

Description

The available parts listed in the Selection Chart can extend the service life of the valve series listed and return the valves to near original operating performance.

Note: For VG7000 Reconditioning Kits, refer to the *VG7000 Series Bronze Globe Valves, Maintenance and Repair Catalog Page (LIT-1924275)*.

Selection Chart

Valve Body	Valve Size, in.	Spring Range, psig	Inner Valve Kit Code Number
V-3752	3/4 UA	3 to 6 or 9 to 13	V-3752-6016 or V-3752-6027
V-3752	1 UA	3 to 6 or 9 to 13	V-3752-6017 or V-3752-6028
V-3752	1-1/4 UA	3 to 6 or 9 to 13	V-3752-6018
V-3752	1- 1/4 UG	3 to 6 or 9 to 13	V-3752-6019
V-3752	1-1/2 UA	3 to 6 or 9 to 13	V-3752-6020 or V-3752-6030
V-3752	2	3 to 6 or 9 to 13	V-3752-6034 or V-3752-6031
V-3800	3/4 UA	3 to 6	V-3800-6001
V-3754-1008	3/4	9 to 13	V-3754-6001
V-3754-1022	3/4	3 to 6	V-3754-6001
V-3754-1026	3/4	3 to 6	V-3754-6001
V-3754-4001	3/4	3 to 6	V-3754-6001
VB-3754-4	3/4		V-3754-6001
VB-3754-4014	3/4		V-3754-6001
V-3754-1010	1	9 to 13	V-3754-6002
V-3754-1023	1	3 to 6	V-3754-6002
V-3754-1027	1	3 to 6	V-3754-6002
V-3754-4002	1	3 to 6	V-3754-6002
VB-3754-5	1		V-3754-6002
VB-3754-8	1-1/4		V-3754-6002
V-3974-1004	3/4	9 to 13	V-3974-6001
V-3974-1010	3/4	9 to 13	V-3974-6001
V-3974-2004	3/4	9 to 13	V-3974-6001
V-3974-4001	3/4	9 to 13	V-3974-6001
VB-3974-4	3/4		V-3974-6001
VB-3974-1005	1		V-3974-6002
V-3974-1011	1	9 to 13	V-3974-6002
V-3974-2005	1	9 to 13	V-3974-6002
V-3974-4002	1	9 to 13	V-3974-6002
V-4324-1005	3/4	4 to 8	V-4324-6001
V-4324-1006	3/4	9 to 13	V-4324-6001
V-4324-1013	3/4	9 to 13	V-4324-6001
V-4324-4001	3/4	4 to 8	V-4324-6001
V-4324-4003	3/4	9 to 13	V-4324-6001
V-4324-4014	3/4		V-4324-6001
VB-4324-4	3/4		V-4324-6001
V-4324-1007	1	4 to 8	V-4324-6002
V-4324-1008	1	9 to 13	V-4324-6002
V-4324-1014	1	9 to 13	V-4324-6002
V-4324-4002	1	4 to 8	V-4324-6002
V-4324-4004	1	9 to 13	V-4324-6002
VB-4324-5	1		V-4324-6002
VB-4324-8	1-1/4		V-4324-6002

Valve Body	Valve Size, in.	Spring Range, psig	Inner Valve Kit Code Number
V-3754-1028	1-1/2	3 to 6	V-5254-6001
V-3754-1029	1-1/2	9 to 13	V-5254-6001
V-3754-1030	1-1/2	3 to 6	V-5254-6001
VB-3754-6	1-1/2		V-5254-6001
V-5254-1	1-1/2	2 to 5	V-5254-6001
V-5254-11	1-1/2	2 to 5	V-5254-6001
V-5254-2	1-1/2	2 to 5	V-5254-6001
V-5254-3	1-1/2	9 to 13	V-5254-6001
VB-3754-7	2		No kits available, replace valve
V-5254-4	2	9 to 13	
V-5254-5	2	2 to 5	
V-5254-6	2	9 to 13	
V-5254-12	2	2 to 5	
V-3974-1012	1-1/2	9 to 13	V-5464-6001
V-3974-1013	1-1/2	9 to 13	V-5464-6001
VB-3974-6	1-1/2		V-5464-6001
V-5464-1	1-1/2	9 to 13	V-5464-6001
V-5464-11	1-1/2	9 to 13	V-5464-6001
V-5464-2	1-1/2	9 to 13	V-5464-6001
VB-3974-7	2		No kits available, replace valve
V-5464-3	2	9 to 13	
V-5464-4	2	9 to 13	
V-5464-12	2	9 to 13	
V-4324-1015	1-1/2	4 to 8	V-5844-6001
V-4324-1016	1-1/2	9 to 13	V-5844-6001
V-4324-1017	1-1/2	9 to 13	V-5844-6001
VB-4324-6	1-1/2		V-5844-6001
V-5844-1	1-1/2	4 to 8	V-5844-6001
V-5844-2	1-1/2	9 to 13	V-5844-6001
V-5844-2	1-1/2	9 to 13	V-5844-6001
V-5844-11	1-1/2	9 to 13	V-5844-6001
VB-4324-7	2		No kits available, replace valve
V-5844-4	2	4 to 8	
V-5844-5	2	9 to 13	
V-5844-6	2	9 to 13	
V-5844-12	2	9 to 13	

Inner Valve Reconditioning Kits: 2-1/2 to 6 in.

Description

The Selection Chart provides repair recommendations for older series of Johnson Controls® 2-1/2 in. through 6 in. valves. Available inner valve kits can extend the service life of many Johnson Controls valves.

Note: For VG2000 Reconditioning Kits, refer to the *VG2000 Series Cast Iron Flanged Globe Valves, Maintenance and Repair Catalog Page (LIT-1900098)*.

Selection Chart

Valve Body	Valve Size, in.	Spring Range, psig	Inner Valve Kit Code Number
VB-3752-19	2-1/2		V-5252-6001
V-5252-7	2-1/2	2 to 5	V-5252-6001
V-5252-8	2-1/2	2 to 5	V-5252-6001
V-5252-33	2-1/2	2 to 5	V-5252-6001
V-5252-32	2-1/2	2 to 5	V-5252-6002
V-5252-4	2-1/2	2 to 5	V-5252-6002
V-5252-5	2-1/2	2 to 5	V-5252-6002
V-5252-6	2-1/2	9 to 13	V-5252-6002
VB-3752-22	3		V-5252-6003
V-5252-12	3	2 to 5	V-5252-6003
V-5252-13	3	2 to 5	V-5252-6003
V-5252-35	3	2 to 5	V-5252-6003
V-5252-10	3	2 to 5	V-5252-6004
V-5252-11	3	9 to 13	V-5252-6004
V-5252-34	3	2 to 5	V-5252-6004
V-5252-9	3	2 to 5	V-5252-6004
VB-3752-25	4		V-5252-6005
V-5252-14	4	2 to 5	V-5252-6005
V-5252-36	4	2 to 5	V-5252-6005
V-5252-15	4	2 to 5	V-5252-6006
V-5252-16	4	2 to 5	V-5252-6006
V-5252-37	4	2 to 5	V-5252-6006
VB-3752-28	5		V-5252-6007
V-5252-17	5	2 to 5	V-5252-6007
V-5252-18	5	2 to 5	V-5252-6007
V-5252-38	5	2 to 5	V-5252-6007
VB-3752-31	6		V-5252-6008
V-5252-19	6	2 to 5	V-5252-6008
V-5252-39	6	2 to 5	V-5252-6008
VB-3970-11	2-1/2		V-5462-6001
V-5462-6	2-1/2	9 to 13	V-5462-6001
V-5462-7	2-1/2	9 to 13	V-5462-6001
V-5462-34	2-1/2	9 to 13	V-5462-6001
VB-3970-14	3		V-5462-6002
V-5462-8	3	9 to 13	V-5462-6002
V-5462-9	3	9 to 13	V-5462-6002
V-5462-35	3	9 to 13	V-5462-6002
V-5462-10	3	9 to 13	V-5462-6003
V-5462-36	3	9 to 13	V-5462-6003

Valve Body	Valve Size, in.	Spring Range, psig	Inner Valve Kit Code Number
VB-3970-17	4		V-5462-6004
V-5462-11	4	9 to 13	V-5462-6004
V-5462-12	4	9 to 13	V-5462-6004
V-5462-37	4	9 to 13	V-5462-6004
V-5462-13	4	9 to 13	V-5462-6005
V-5462-14	4	9 to 13	V-5462-6005
V-5462-38	4	9 to 13	V-5462-6005
VB-3970-20	5		V-5462-6006
V-5462-15	5	9 to 13	V-5462-6006
V-5462-39	5	9 to 13	V-5462-6006
VB-3970-23	6		V-5462-6007
V-5462-17	6	9 to 13	V-5462-6007
V-5462-18	6	9 to 13	V-5462-6007
V-5462-40	6	9 to 13	V-5462-6007
VB-4322-9	2-1/2		V-5842-6001
V-5842-31	2-1/2	9 to 13	V-5842-6001
V-5842-8	2-1/2	9 to 13	V-5842-6001
VB-4322-11	3		V-5842-6002
V-5842-10	3	9 to 13	V-5842-6002
V-5842-32	3	9 to 13	V-5842-6002
V-5842-17	3	9 to 13	V-5842-6003
V-5842-18	3	9 to 13	V-5842-6003
V-5842-33	3	9 to 13	V-5842-6003
VB-4322-13	4		V-5842-6004
V-5842-11	4	9 to 13	V-5842-6005
V-5842-12	4	9 to 13	V-5842-6005
V-5842-34	4	9 to 13	V-5842-6005
VB-4322-19	5		V-5842-6006
V-5842-13	5	9 to 13	V-5842-6006
V-5442-14	5	9 to 13	V-5842-6006
V-5842-35	5	9 to 13	V-5842-6006
V-5842-16	6	9 to 13	V-5842-6007
VB-4322-18	6	9 to 13	V-5842-6007
V-5842-15	6	9 to 13	V-5842-6007
V-5842-36	6	9 to 13	V-5842-6007

Sizing Water Valves

Two-Position Applications: The valve is normally sized to the pipe size with the largest Cv.

Modulating Applications: The valve should be sized to produce the required gallons per minute (gpm) flow at a pressure drop of one to two times the pressure drop across the coil at design flow.

Example: To select a VG1000 Series Ball Valve for a coil that requires 14 gpm at 5 psi pressure drop. The valve should be selected to provide 14 gpm with a pressure drop across the valve between 5 and 10 psi (one to two times the pressure drop across the coil at the required flow).

Solution: From the *VG1000 Series Ball Valves* table that follows, a 1/2 in., 4.7 Cv valve provides 14.1 gpm flow at a pressure drop across the valve of 9 psi. This is the valve to be selected, as the valve provides the needed flow with a pressure drop between one and two times the pressure drop across the coil at the required flow.

Flow Rates in gpm



VG1000 Series Ball Valve

WARNING This product is made of copper alloy, which contains lead. The product is therefore not to be used on drinking water.

WARNING This product can expose you to chemicals including lead, which is known to the State of California to cause cancer, birth defects, or other reproductive harm. For more information, go to www.P65Warnings.ca.gov.

VG1000 Series Ball Valves

Cv	1.2	1.9	2.9	4.7	7.4	11.7	18.7	29.2	46.8	73.7
Pressure Drop, psi	Flow Rate, gpm									
1	1.2	1.9	2.9	4.7	7.4	11.7	18.7	29.2	46.8	73.7
2	1.7	2.7	4.1	6.6	10.5	16.5	26.4	41.3	66.2	104.2
3	2.1	3.3	5.0	8.1	12.8	20.3	32.4	50.6	81.1	127.7
4	2.4	3.8	5.8	9.4	14.8	23.4	37.4	58.4	93.6	147.4
5	2.7	4.2	6.5	10.5	16.5	26.2	41.8	65.3	104.6	164.8
6	2.9	4.7	7.1	11.5	18.1	28.7	45.8	71.5	114.6	180.5
7	3.2	5.0	7.7	12.4	19.6	31.0	49.5	77.3	123.8	195.0
8	3.4	5.4	8.2	13.3	20.9	33.1	52.9	82.6	132.4	208.5
9	3.6	5.7	8.7	14.1	22.2	35.1	56.1	87.6	140.4	221.1
10	3.8	6.0	9.2	14.9	23.4	37.0	59.1	92.3	148.0	233.1
11	4.0	6.3	9.6	15.6	24.5	38.8	62.0	96.8	155.2	244.4
12	4.2	6.6	10.0	16.3	25.6	40.5	64.8	101.2	162.1	255.3
13	4.3	6.9	10.5	16.9	26.7	42.2	67.4	105.3	168.7	265.7
14	4.5	7.1	10.9	17.6	27.7	43.8	70.0	109.3	175.1	275.8
15	4.6	7.4	11.2	18.2	28.7	45.3	72.4	113.1	181.3	285.4
16	4.8	7.6	11.6	18.8	29.6	46.8	74.8	116.8	187.2	294.8
17	4.9	7.8	12.0	19.4	30.5	48.2	77.1	120.4	193.0	303.9
18	5.1	8.1	12.3	19.9	31.4	49.6	79.3	123.9	198.6	312.7
19	5.2	8.3	12.6	20.5	32.3	51.0	81.5	127.3	204.0	321.3
20	5.4	8.5	13.0	21.0	33.1	52.3	83.6	130.6	209.3	329.6
21	5.5	8.7	13.3	21.5	33.9	53.6	85.7	133.8	214.5	337.7
22	5.6	8.9	13.6	22.0	34.7	54.9	87.7	137.0	219.5	345.7
23	5.8	9.1	13.9	22.5	35.5	56.1	89.7	140.0	224.4	353.5
24	5.9	9.3	14.2	23.0	36.3	57.3	91.6	143.1	229.3	361.1
25	6.0	9.5	14.5	23.5	37.0	58.5	93.5	146.0	234.0	368.5
26	6.1	9.7	14.8	24.0	37.7	59.7	95.4	148.9	238.6	375.8
27	6.2	9.9	15.1	24.4	38.5	60.8	97.2	151.7	243.2	383.0
28	6.3	10.1	15.3	24.9	39.2	61.9	99.0	154.5	247.6	390.0
29	6.5	10.2	15.6	25.3	39.9	63.0	100.7	157.2	252.0	396.9
30	6.6	10.4	15.9	25.7	40.5	64.1	102.4	159.9	256.3	403.7

The performance specifications are nominal and conform to acceptable industry standards. For applications at conditions beyond these specifications, consult the local Johnson Controls office. Johnson Controls shall not be liable for damages resulting from misapplication or misuse of its products. © 2019 Johnson Controls. www.johnsoncontrols.com

Sizing Water Valves (Continued)



VG1000 Series Flanged Ball Valve

VG1000 Series Flanged Ball Valves

Cv	47	74	117	176	211	290	406
Pressure Drop, psi	Flow Rate, gpm						
1	47.0	74.0	117	176	211	290	348
2	66.5	105	165	249	298	410	492
3	81.4	128	203	305	365	502	603
4	94	148	234	352	422	580	696
5	105	165	262	394	472	648	778
6	115	181	287	431	517	710	852
7	124	196	310	466	558	767	921
8	133	209	331	498	597	820	984
9	141	222	351	528	633	870	1,044
10	149	234	370	557	667	917	1,100
11	156	245	388	584	700	962	1,154
12	163	256	405	610	731	1,005	1,206
13	169	267	422	635	761	1,046	1,255
14	176	277	438	659	789	1,085	1,302
15	182	287	453	682	817	1,123	1,348
16	188	296	468	704	844	1,160	1,392
17	194	305	482	726	870	1,196	1,435
18	199	314	496	747	895	1,230	1,476
19	205	323	510	767	920	1,264	1,517
20	210	331	523	787	944	1,297	1,556
21	215	339	536	807	967	1,329	1,595
22	220	347	549	826	990	1,360	1,632
23	225	355	561	844	1,012	1,391	1,669
24	230	363	573	862	1,034	1,421	1,705
25	235	370	585	880	1,055	1,450	1,740
26	240	377	597	897	1,076	1,479	1,774
27	244	385	608	915	1,096	1,507	1,808
28	249	392	619	931	1,117	1,535	1,841
29	253	399	630	948	1,136	1,562	1,874
30	257	405	641	964	1,156	1,588	1,906

The performance specifications are nominal and conform to acceptable industry standards. For applications at conditions beyond these specifications, consult the local Johnson Controls office. Johnson Controls shall not be liable for damages resulting from misapplication or misuse of its products. © 2019 Johnson Controls. www.johnsoncontrols.com

Sizing Water Valves (Continued)



VG2000 Series Flanged Cast Iron Globe Valves

VG2000 Series Flanged Cast Iron Globe Valves

Pipe Size, in.	Two-Way					Three-Way				
	2-1/2	3	4	5	6	2-1/2	3	4	5	6
Cv	51	83	150	240	350	54	80	157	238	347
Pressure Drop, psi	Flow Rate, gpm									
1	51.0	83.0	150.0	240.0	350.0	54.0	80.0	157.0	238.0	347.0
2	72.1	117.4	212.1	339.4	495.0	76.4	113.1	222.0	336.6	490.7
3	88.3	143.8	259.8	415.7	606.2	93.5	138.6	271.9	412.2	601.0
4	102.0	166.0	300.0	480.0	700.0	108.0	160.0	314.0	476.0	694.0
5	114.0	185.6	335.4	536.7	782.6	120.7	178.9	351.1	532.2	775.9
6	124.9	203.3	367.4	587.9	857.3	132.3	196.0	384.6	583.0	850.0
7	134.9	219.6	396.9	635.0	926.0	142.9	211.7	415.4	629.7	918.1
8	144.2	234.8	424.3	678.8	989.9	152.7	226.3	444.1	673.2	981.5
9	153.0	249.0	450.0	720.0	1,050.0	162.0	240.0	471.0	714.0	1,041.0
10	161.3	262.5	474.3	758.9	1,106.8	170.8	253.0	496.5	752.6	1,097.3
11	169.1	275.3	497.5	796.0	1,160.8	179.1	265.3	520.7	789.4	1,150.9
12	176.7	287.5	519.6	831.4	1,212.4	187.1	277.1	543.9	824.5	1,202.0
13	183.9	299.3	540.8	865.3	1,261.9	194.7	288.4	566.1	858.1	1,251.1
14	190.8	310.6	561.2	898.0	1,309.6	202.0	299.3	587.4	890.5	1,298.4
15	197.5	321.5	580.9	929.5	1,355.5	209.1	309.8	608.1	921.8	1,343.9
16	204.0	332.0	600.0	960.0	1,400.0	216.0	320.0	628.0	952.0	1,388.0
17	210.3	342.2	618.5	989.5	1,443.1	222.6	329.8	647.3	981.3	1,430.7
18	216.4	352.1	636.4	1,018.2	1,484.9	229.1	339.4	666.1	1,009.7	1,472.2
19	222.3	361.8	653.8	1,046.1	1,525.6	235.4	348.7	684.3	1,037.4	1,512.5
20	228.1	371.2	670.8	1,073.3	1,565.2	241.5	357.8	702.1	1,064.4	1,551.8
21	233.7	380.4	687.4	1,099.8	1,603.9	247.5	366.6	719.5	1,090.7	1,590.2
22	239.2	389.3	703.6	1,125.7	1,641.6	253.3	375.2	736.4	1,116.3	1,627.6
23	244.6	398.1	719.4	1,151.0	1,678.5	259.0	383.7	752.9	1,141.4	1,664.2
24	249.8	406.6	734.8	1,175.8	1,714.6	264.5	391.9	769.1	1,166.0	1,699.9
25	255.0	415.0	750.0	1,200.0	1,750.0	270.0	400.0	785.0	1,190.0	1,735.0
26	260.0	423.2	764.9	1,223.8	1,784.7	275.3	407.9	800.5	1,213.6	1,769.4
27	265.0	431.3	779.4	1,247.1	1,818.7	280.6	415.7	815.8	1,236.7	1,803.1
28	269.9	439.2	793.7	1,270.0	1,852.0	285.7	423.3	830.8	1,259.4	1,836.2
29	274.6	447.0	807.8	1,292.4	1,884.8	290.8	430.8	845.5	1,281.7	1,868.7
30	279.3	454.6	821.6	1,314.5	1,917.0	295.8	438.2	859.9	1,303.6	1,900.6

The performance specifications are nominal and conform to acceptable industry standards. For applications at conditions beyond these specifications, consult the local Johnson Controls office. Johnson Controls shall not be liable for damages resulting from misapplication or misuse of its products. © 2019 Johnson Controls. www.johnsoncontrols.com

Sizing Water Valves (Continued)



VG7000 Series Bronze Globe Valves

VG7000 Series Bronze Globe Valves

Pipe Size, in.	1/2	3/4	1	1-1/4	1-1/2	2		
Cv	0.73	1.8	4.6	7.3	11.6	18.5	28.9	46.2
Pressure Drop, psi	Flow Rate, gpm							
1	0.7	1.8	4.6	7.3	11.6	18.5	28.9	46.2
2	1.0	2.5	6.5	10.3	16.4	26.2	40.9	65.3
3	1.3	3.1	8.0	12.6	20.1	32.0	50.1	80.0
4	1.5	3.6	9.2	14.6	23.2	37.0	57.8	92.4
5	1.6	4.0	10.3	16.3	25.9	41.4	64.6	103.3
6	1.8	4.4	11.3	17.9	28.4	45.3	70.8	113.2
7	1.9	4.8	12.2	19.3	30.7	48.9	76.5	122.2
8	2.1	5.1	13.0	20.6	32.8	52.3	81.7	130.7
9	2.2	5.4	13.8	21.9	34.8	55.5	86.7	138.6
10	2.3	5.7	14.5	23.1	36.7	58.5	91.4	146.1
11	2.4	6.0	15.3	24.2	38.5	61.4	95.9	153.2
12	2.5	6.2	15.9	25.3	40.2	64.1	100.1	160.0
13	2.6	6.5	16.6	26.3	41.8	66.7	104.2	166.6
14	2.7	6.7	17.2	27.3	43.4	69.2	108.1	172.9
15	2.8	7.0	17.8	28.3	44.9	71.7	111.9	178.9
16	2.9	7.2	18.4	29.2	46.4	74.0	115.6	184.8
17	3.0	7.4	19.0	30.1	47.8	76.3	119.2	190.5
18	3.1	7.6	19.5	31.0	49.2	78.5	122.6	196.0
19	3.2	7.8	20.1	31.8	50.6	80.6	126.0	201.4
20	3.3	8.0	20.6	32.6	51.9	82.7	129.2	206.6
21	3.3	8.2	21.1	33.5	53.2	84.8	132.4	211.7
22	3.4	8.4	21.6	34.2	54.4	86.8	135.6	216.7
23	3.5	8.6	22.1	35.0	55.6	88.7	138.6	221.6
24	3.6	8.8	22.5	35.8	56.8	90.6	141.6	226.3
25	3.7	9.0	23.0	36.5	58.0	92.5	144.5	231.0
26	3.7	9.2	23.5	37.2	59.1	94.3	147.4	235.6
27	3.8	9.4	23.9	37.9	60.3	96.1	150.2	240.1
28	3.9	9.5	24.3	38.6	61.4	97.9	152.9	244.5
29	3.9	9.7	24.8	39.3	62.5	99.6	155.6	248.8
30	4.0	9.9	25.2	40.0	63.5	101.3	158.3	253.0

The performance specifications are nominal and conform to acceptable industry standards. For applications at conditions beyond these specifications, consult the local Johnson Controls office. Johnson Controls shall not be liable for damages resulting from misapplication or misuse of its products. © 2019 Johnson Controls. www.johnsoncontrols.com

Sizing Water Valves (Continued)



J Series Electric Zone Valves

J Series Electric Zone Valves

Cv	JM Series Modulating					JS/JT Series On/Off					
	1	2	4	7.5	8	1	2.5	3.5	4	5	8
Pressure Drop, psi	Flow Rate, gpm										
1	1.0	2.0	4.0	7.5	8.0	1.0	2.5	3.5	4.0	5.0	8.0
2	1.4	2.8	5.7	10.6	11.3	1.4	3.5	4.9	5.7	7.1	11.3
3	1.7	3.5	6.9	13.0	13.9	1.7	4.3	6.1	6.9	8.7	13.9
4	2.0	4.0	8.0	15.0	16.0	2.0	5.0	7.0	8.0	10.0	16.0
5	2.2	4.5	8.9	16.8	17.9	2.2	5.6	7.8	8.9	11.2	17.9
6	2.4	4.9	9.8	18.4	19.6	2.4	6.1	8.6	9.8	12.2	19.6
7	2.6	5.3	10.6	19.8	21.2	2.6	6.6	9.3	10.6	13.2	21.2
8	2.8	5.7	11.3	21.2	22.6	2.8	7.1	9.9	11.3	14.1	22.6
9	3.0	6.0	12.0	22.5	24.0	3.0	7.5	10.5	12.0	15.0	24.0
10	3.2	6.3	12.6	23.7	25.3	3.2	7.9	11.1	12.6	15.8	25.3
11	3.3	6.6	13.3	24.9	26.5	3.3	8.3	11.6	13.3	16.6	26.5
12	3.5	6.9	13.9	26.0	27.7	3.5	8.7	12.1	13.9	17.3	27.7
13	3.6	7.2	14.4	27.0	28.8	3.6	9.0	12.6	14.4	18.0	28.8
14	3.7	7.5	15.0	28.1	29.9	3.7	9.4	13.1	15.0	18.7	29.9
15	3.9	7.7	15.5	29.0	31.0	3.9	9.7	13.6	15.5	19.4	31.0
16	4.0	8.0	16.0	30.0	32.0	4.0	10.0	14.0	16.0	20.0	32.0
17	4.1	8.2	16.5	30.9	33.0	4.1	10.3	14.4	16.5	20.6	33.0
18	4.2	8.5	17.0	31.8	33.9	4.2	10.6	14.8	17.0	21.2	33.9
19	4.4	8.7	17.4	32.7	34.9	4.4	10.9	15.3	17.4	21.8	34.9
20	4.5	8.9	17.9	33.5	35.8	4.5	11.2	15.7	17.9	22.4	35.8
21	4.6	9.2	18.3	34.4	36.7	4.6	11.5	16.0	18.3	22.9	36.7
22	4.7	9.4	18.8	35.2	37.5	4.7	11.7	16.4	18.8	23.5	37.5
23	4.8	9.6	19.2	36.0	38.4	4.8	12.0	16.8	19.2	24.0	38.4
24	4.9	9.8	19.6	36.7	39.2	4.9	12.2	17.1	19.6	24.5	39.2
25	5.0	10.0	20.0	37.5	40.0	5.0	12.5	17.5	20.0	25.0	40.0
26	5.1	10.2	20.4	38.2	40.8	5.1	12.7	17.8	20.4	25.5	40.8
27	5.2	10.4	20.8	39.0	41.6	5.2	13.0	18.2	20.8	26.0	41.6
28	5.3	10.6	21.2	39.7	42.3	5.3	13.2	18.5	21.2	26.5	42.3
29	5.4	10.8	21.5	40.4	43.1	5.4	13.5	18.8	21.5	26.9	43.1
30	5.5	11.0	21.9	41.1	43.8	5.5	13.7	19.2	21.9	27.4	43.8

The performance specifications are nominal and conform to acceptable industry standards. For applications at conditions beyond these specifications, consult the local Johnson Controls office. Johnson Controls shall not be liable for damages resulting from misapplication or misuse of its products. © 2019 Johnson Controls. www.johnsoncontrols.com

Sizing Water Valves (Continued)



VFX- Series Standard-Performance Butterfly Valve

VFX- Series Standard-Performance Butterfly Valves, 60° Open

Pipe Size, in.	Cv at 60° Open for Modulating Service												
	2	2-1/2	3	4	5	6	8	10	12	14	16	18	20
Cv	61	107	154	274	428	567	1,081	1,710	2,563	3,384	4,483	5,736	7,144
Pressure Drop, psi	Flow Rate, gpm												
1	61	107	154	274	428	567	1,081	1,710	2,563	3,384	4,483	5,736	7,144
2	86	151	218	387	605	802	1,529	2,418	3,625	4,786	6,340	8,112	10,103
3	106	185	267	475	741	982	1,872	2,962	4,439	5,861	7,765	9,935	12,374
4	122	214	308	548	856	1,134	2,162	3,420	5,126	6,768	8,966	11,472	14,288
5	136	239	344	613	957	1,268	2,417	3,824	5,731	7,567	10,024	12,826	15,974
6	149	262	377	671	1,048	1,389	2,648	4,189	6,278	8,289	10,981	14,050	17,499
7	161	283	407	725	1,132	1,500	2,860	4,524	6,781	8,953	11,861	15,176	18,901
8	173	303	436	775	1,211	1,604	3,058	4,837	7,249	9,571	12,680	16,224	20,206
9	183	321	462	822	1,284	1,701	3,243	5,130	7,689	10,152	13,449	17,208	21,432
10	193	338	487	866	1,353	1,793	3,418	5,407	8,105	10,701	14,176	18,139	22,591
11	202	355	511	909	1,420	1,881	3,585	5,671	8,501	11,223	14,868	19,024	23,694
12	211	371	533	949	1,483	1,964	3,745	5,924	8,878	11,723	15,530	19,870	24,748
13	220	386	555	988	1,543	2,044	3,898	6,165	9,241	12,201	16,164	20,681	25,758
14	228	400	576	1,025	1,601	2,122	4,045	6,398	9,590	12,662	16,774	21,462	26,730
15	236	414	596	1,061	1,658	2,196	4,187	6,623	9,926	13,106	17,363	22,215	27,669
16	244	428	616	1,096	1,712	2,268	4,324	6,840	10,252	13,536	17,932	22,944	28,576
17	252	441	635	1,130	1,765	2,338	4,457	7,051	10,568	13,953	18,484	23,650	29,455
18	259	454	653	1,162	1,816	2,406	4,586	7,255	10,874	14,357	19,020	24,336	30,309
19	266	466	671	1,194	1,866	2,471	4,712	7,454	11,172	14,751	19,541	25,003	31,140
20	273	479	689	1,225	1,914	2,536	4,834	7,647	11,462	15,134	20,049	25,652	31,949
21	280	490	706	1,256	1,961	2,598	4,954	7,836	11,745	15,507	20,544	26,286	32,738
22	286	502	722	1,285	2,007	2,659	5,070	8,021	12,022	15,872	21,027	26,904	33,508
23	293	513	739	1,314	2,053	2,719	5,184	8,201	12,292	16,229	21,500	27,509	34,261
24	299	524	754	1,342	2,097	2,778	5,296	8,377	12,556	16,578	21,962	28,101	34,998
25	305	535	770	1,370	2,140	2,835	5,405	8,550	12,815	16,920	22,415	28,680	35,720
26	311	546	785	1,397	2,182	2,891	5,512	8,719	13,069	17,255	22,859	29,248	36,427
27	317	556	800	1,424	2,224	2,946	5,617	8,885	13,318	17,584	23,294	29,805	37,121
28	323	566	815	1,450	2,265	3,000	5,720	9,048	13,562	17,906	23,722	30,352	37,802
29	328	576	829	1,476	2,305	3,053	5,821	9,209	13,802	18,223	24,142	30,889	38,472
30	334	586	843	1,501	2,344	3,106	5,921	9,366	14,038	18,535	24,554	31,417	39,129

The performance specifications are nominal and conform to acceptable industry standards. For applications at conditions beyond these specifications, consult the local Johnson Controls office. Johnson Controls shall not be liable for damages resulting from misapplication or misuse of its products. © 2019 Johnson Controls. www.johnsoncontrols.com

Sizing Water Valves (Continued)



VFx- Series Standard-Performance Butterfly Valve

VFx- Series Standard-Performance Butterfly Valves

	Cv at 70° Open for Modulating Service												
Pipe Size, in.	2	2-1/2	3	4	5	6	8	10	12	14	16	18	20
Cv	84	163	267	496	775	1,025	1,862	2,948	4,393	5,939	7,867	10,065	12,535
Pressure Drop, psi	Flow Rate, gpm												
1	84	163	267	496	775	1,025	1,862	2,948	4,393	5,939	7,867	10,065	12,535
2	119	231	378	701	1,096	1,450	2,633	4,169	6,213	8,399	11,126	14,234	17,727
3	146	282	463	859	1,342	1,775	3,225	5,106	7,609	10,287	13,626	17,433	21,711
4	168	326	534	992	1,550	2,050	3,724	5,896	8,786	11,878	15,734	20,130	25,070
5	188	365	597	1,109	1,733	2,292	4,164	6,592	9,823	13,280	17,591	22,506	28,029
6	206	399	654	1,215	1,898	2,511	4,561	7,221	10,761	14,548	19,270	24,654	30,704
7	222	431	706	1,312	2,051	2,712	4,926	7,800	11,623	15,713	20,814	26,630	33,165
8	238	461	755	1,403	2,192	2,899	5,267	8,338	12,425	16,798	22,251	28,468	35,454
9	252	489	801	1,488	2,325	3,075	5,586	8,844	13,179	17,817	23,601	30,195	37,605
10	266	516	844	1,569	2,451	3,241	5,888	9,322	13,892	18,781	24,878	31,828	39,639
11	279	541	886	1,645	2,570	3,400	6,176	9,777	14,570	19,697	26,092	33,382	41,574
12	291	566	925	1,718	2,685	3,551	6,450	10,212	15,218	20,573	27,252	34,866	43,423
13	303	588	963	1,788	2,794	3,696	6,714	10,629	15,839	21,413	28,365	36,290	45,196
14	314	610	999	1,856	2,900	3,835	6,967	11,030	16,437	22,222	29,436	37,660	46,902
15	325	631	1,034	1,921	3,002	3,970	7,212	11,418	17,014	23,002	30,469	38,982	48,548
16	336	652	1,068	1,984	3,100	4,100	7,448	11,792	17,572	23,756	31,468	40,260	50,140
17	346	672	1,101	2,045	3,095	4,226	7,677	12,155	18,113	24,487	32,437	41,499	51,683
18	356	692	1,133	2,104	3,288	4,349	7,900	12,507	18,638	25,197	33,377	42,702	53,182
19	366	711	1,164	2,162	3,378	4,468	8,116	12,850	19,149	25,888	34,292	43,872	54,639
20	376	729	1,194	2,218	3,466	4,584	8,327	13,184	19,646	26,560	35,182	45,012	56,058
21	385	747	1,224	2,273	3,552	4,679	8,533	13,509	20,131	27,216	36,051	46,124	57,443
22	394	765	1,252	2,326	3,635	4,808	8,734	13,827	20,605	27,856	36,900	47,209	58,794
23	403	782	1,281	2,379	3,717	4,916	8,930	14,138	21,068	28,482	37,729	48,270	60,116
24	412	799	1,308	2,430	3,797	5,022	9,122	14,442	21,521	29,095	38,540	49,308	61,409
25	420	815	1,335	2,480	3,875	5,125	9,310	14,740	21,956	29,695	39,355	50,325	62,675
26	428	831	1,361	2,529	3,952	5,227	9,494	15,032	22,400	30,283	40,114	51,322	63,916
27	437	847	1,387	2,577	4,027	5,326	9,675	15,318	22,827	30,860	40,878	52,299	65,134
28	445	863	1,413	2,625	4,101	5,424	9,853	15,599	23,246	31,426	41,628	53,259	66,329
29	452	878	1,438	2,671	4,174	5,520	10,027	15,876	23,657	31,983	42,635	54,202	67,503
30	460	893	1,462	2,717	4,245	5,614	10,199	16,147	24,062	32,529	43,089	55,128	68,657

The performance specifications are nominal and conform to acceptable industry standards. For applications at conditions beyond these specifications, consult the local Johnson Controls office. Johnson Controls shall not be liable for damages resulting from misapplication or misuse of its products. © 2019 Johnson Controls. www.johnsoncontrols.com

Sizing Water Valves (Continued)



VFx- Series Standard-Performance Butterfly Valves

VFx- Series Standard-Performance Butterfly Valves

	Cv at 90° Open for On/Off Service												
Pipe Size, in.	2	2-1/2	3	4	5	6	8	10	12	14	16	18	20
Cv	144	282	461	841	1,376	1,850	3,316	5,430	8,077	10,538	13,966	17,214	22,339
Pressure Drop, psi	Flow Rate, gpm												
1	144	282	461	841	1,376	1,850	3,316	5,430	8,077	10,538	13,966	17,214	22,339
2	204	399	652	1,189	1,946	2,616	4,690	7,679	11,423	14,903	19,751	24,344	31,592
3	249	488	799	1,457	2,383	3,204	5,744	9,405	13,990	18,252	24,190	29,816	38,692
4	288	564	922	1,682	2,752	3,700	6,632	10,860	16,154	21,076	27,932	34,428	44,678
5	322	631	1,031	1,881	3,077	4,137	7,415	12,142	18,061	23,564	31,229	38,492	49,952
6	353	691	1,129	2,060	3,371	4,532	8,123	13,301	19,785	25,813	34,210	42,166	54,719
7	381	746	1,220	2,225	3,641	4,895	8,773	14,366	21,370	27,881	36,951	45,544	59,103
8	407	798	1,304	2,379	3,892	5,233	9,379	15,358	22,845	29,806	39,502	48,689	63,184
9	432	846	1,383	2,523	4,128	5,550	9,948	16,290	24,231	31,614	41,898	51,642	67,017
10	455	892	1,458	2,660	4,351	5,850	10,486	17,171	25,542	33,324	44,164	54,435	70,642
11	478	935	1,529	2,789	4,564	6,136	10,998	18,009	26,788	34,951	46,320	57,092	74,090
12	499	977	1,597	2,913	4,767	6,409	11,487	18,810	27,980	36,505	48,380	59,631	77,385
13	519	1,017	1,662	3,032	4,961	6,670	11,956	19,578	29,122	37,995	50,355	62,066	80,544
14	539	1,055	1,725	3,147	5,149	6,922	12,407	20,317	30,221	39,430	52,256	64,409	83,585
15	558	1,092	1,785	3,257	5,329	7,165	12,843	21,030	31,282	40,814	54,090	66,670	86,519
16	576	1,128	1,844	3,364	5,504	7,400	13,264	21,720	32,308	42,152	55,864	68,856	89,356
17	594	1,163	1,901	3,468	5,673	7,628	13,672	22,389	33,302	43,449	57,583	70,975	92,106
18	611	1,196	1,956	3,568	5,838	7,849	14,069	23,038	34,268	44,709	59,253	73,033	94,776
19	628	1,229	2,010	3,666	5,998	8,064	14,454	23,669	35,207	45,934	60,876	75,034	97,373
20	644	1,261	2,062	3,761	6,154	8,274	14,830	24,284	36,121	47,127	62,458	76,983	99,903
21	660	1,292	2,113	3,854	6,306	8,478	15,196	24,883	37,014	48,291	64,000	78,885	102,370
22	675	1,323	2,162	3,945	6,454	8,677	15,553	25,469	37,885	49,428	65,506	80,741	104,779
23	691	1,352	2,211	4,033	6,599	8,872	15,903	26,041	38,736	50,539	66,979	82,555	107,134
24	706	1,382	2,258	4,120	6,741	9,063	16,245	26,602	39,569	51,625	68,419	84,331	109,438
25	720	1,410	2,305	4,205	6,880	9,250	16,580	27,150	40,385	52,690	69,830	86,070	111,695
26	734	1,438	2,351	4,288	7,016	9,433	16,908	27,688	41,185	53,734	71,213	87,775	113,907
27	748	1,465	2,395	4,370	7,150	9,613	17,230	28,215	41,969	54,757	72,570	89,447	116,077
28	762	1,492	2,439	4,450	7,281	9,789	17,547	28,733	42,740	55,762	73,901	91,088	118,207
29	776	1,519	2,483	4,529	7,410	9,963	17,857	29,241	43,496	56,749	75,209	92,700	120,299
30	789	1,545	2,525	4,606	7,537	10,133	18,163	29,741	44,240	57,719	76,495	94,285	122,356

The performance specifications are nominal and conform to acceptable industry standards. For applications at conditions beyond these specifications, consult the local Johnson Controls office. Johnson Controls shall not be liable for damages resulting from misapplication or misuse of its products. © 2019 Johnson Controls. www.johnsoncontrols.com

Sizing Water Valves (Continued)



VFx- Series High-Performance Class 150 Butterfly Valves

VFx- Series High-Performance Class 150 Butterfly Valves

	Cv at 60° Open for On/Off Service									
Pipe Size, in.	2-1/2	3	4	5	6	8	10	12	14	16
Cv	78	123	250	360	510	1,060	1,630	2,530	2,900	3,700
Pressure Drop, psi	Flow Rate, gpm									
1	78	123	250	360	510	1,060	1,630	2,530	2,900	3,700
2	110	174	354	509	721	1,499	2,305	3,578	4,101	5,233
3	135	213	433	624	883	1,836	2,823	4,382	5,023	6,409
4	156	246	500	720	1,020	2,120	3,260	5,060	5,800	7,400
5	174	275	559	805	1,140	2,370	3,645	5,657	6,485	8,273
6	191	301	612	882	1,249	2,596	3,993	6,197	7,104	9,063
7	206	325	661	952	1,349	2,804	4,313	6,694	7,673	9,789
8	221	348	707	1,018	1,442	2,998	4,610	7,156	8,202	10,465
9	234	369	750	1,080	1,530	3,180	4,890	7,590	8,700	11,100
10	247	389	791	1,138	1,613	3,352	5,155	8,001	9,171	11,700
11	259	408	829	1,194	1,691	3,516	5,406	8,391	9,618	12,272
12	270	426	866	1,247	1,767	3,672	5,646	8,764	10,046	12,817
13	281	443	901	1,298	1,839	3,822	5,877	9,112	10,456	13,341
14	292	460	935	1,347	1,908	3,966	6,099	9,466	10,851	13,844
15	302	476	968	1,394	1,975	4,105	6,313	9,799	11,232	14,330
16	312	492	1,000	1,440	2,040	4,240	6,520	10,120	11,600	14,800
17	322	507	1,031	1,484	2,103	4,370	6,721	10,431	11,957	15,255
18	331	522	1,061	1,527	2,164	4,497	6,916	10,734	12,304	15,698
19	340	536	1,090	1,569	2,223	4,620	7,105	11,028	12,641	16,128
20	349	550	1,118	1,610	2,281	4,740	7,290	11,315	12,969	16,547
21	357	564	1,146	1,650	2,337	4,858	7,470	11,594	13,289	16,956
22	366	577	1,173	1,689	2,392	4,972	7,645	11,867	13,602	17,355
23	374	590	1,199	1,726	2,446	5,084	7,817	12,133	13,908	17,745
24	382	603	1,225	1,764	2,498	5,193	7,985	12,394	14,207	18,126
25	390	615	1,250	1,800	2,550	5,300	8,150	12,650	14,500	18,500
26	398	627	1,275	1,836	2,600	5,405	8,311	12,901	14,787	18,866
27	405	639	1,299	1,871	2,650	5,508	8,470	13,146	15,069	19,226
28	413	651	1,323	1,905	2,699	5,609	8,625	13,388	15,345	19,579
29	420	662	1,346	1,939	2,746	5,708	8,778	13,624	15,617	19,925
30	427	674	1,369	1,972	2,793	5,806	8,928	13,857	15,884	20,266

The performance specifications are nominal and conform to acceptable industry standards. For applications at conditions beyond these specifications, consult the local Johnson Controls office. Johnson Controls shall not be liable for damages resulting from misapplication or misuse of its products. © 2019 Johnson Controls. www.johnsoncontrols.com

Sizing Water Valves (Continued)



VFx- Series High-Performance Class 150 Butterfly Valves

VFx- Series High-Performance Class 150 Butterfly Valves

	Cv at 90° Open for On/Off Service									
Pipe Size, in.	2-1/2	3	4	5	6	8	10	12	14	16
Cv	160	185	375	790	1,350	2,800	4,300	6,650	7,650	9,800
Pressure Drop, psi	Flow Rate, gpm									
1	160	185	375	790	1,350	2,800	4,300	6,650	7,650	9,800
2	226	262	530	1,117	1,909	3,960	6,081	9,405	10,819	13,859
3	277	320	650	1,368	2,338	4,850	7,448	11,518	13,250	16,974
4	320	370	750	1,580	2,700	5,600	8,600	13,300	15,300	19,600
5	358	414	839	1,767	3,019	6,261	9,615	14,870	17,106	21,914
6	392	453	919	1,935	3,307	6,859	10,533	16,289	18,739	24,005
7	423	490	992	2,090	3,572	7,408	11,377	17,594	20,240	25,928
8	453	523	1,061	2,235	3,818	7,920	12,162	18,809	21,638	27,719
9	480	555	1,125	2,370	4,050	8,400	12,900	19,950	22,950	29,400
10	506	585	1,186	2,498	4,269	8,854	13,598	21,029	24,191	30,990
11	531	614	1,244	2,620	4,477	9,287	14,262	22,056	25,372	32,503
12	554	641	1,299	2,737	4,677	9,700	14,896	23,036	26,500	33,948
13	577	667	1,352	2,848	4,868	10,096	15,504	23,977	27,583	35,334
14	599	692	1,403	2,956	5,051	10,477	16,089	24,882	28,624	36,668
15	620	717	1,452	3,060	5,229	10,844	16,654	25,755	29,628	37,955
16	640	740	1,500	3,160	5,400	11,200	17,200	26,600	30,600	39,200
17	660	763	1,546	3,257	5,566	11,545	17,729	27,419	31,542	40,406
18	679	785	1,591	3,352	5,728	11,879	18,243	28,214	32,456	41,578
19	697	806	1,635	3,444	5,885	12,205	18,743	28,987	33,346	42,717
20	716	827	1,677	3,533	6,037	12,522	19,230	29,740	34,212	43,827
21	733	848	1,719	3,620	6,187	12,831	19,705	30,474	35,057	44,909
22	751	868	1,759	3,705	6,332	13,133	20,169	31,191	35,882	45,966
23	767	887	1,798	3,789	6,474	13,428	20,622	31,892	36,688	46,999
24	784	906	1,837	3,870	6,614	13,717	21,066	32,578	37,477	48,010
25	800	925	1,875	3,950	6,750	14,000	21,500	33,250	38,250	49,000
26	816	943	1,912	4,028	6,884	14,277	21,926	33,909	39,008	49,970
27	831	961	1,949	4,105	7,015	14,549	22,344	34,554	39,751	50,922
28	847	979	1,984	4,180	7,144	14,816	22,754	35,189	40,480	51,857
29	862	996	2,019	4,254	7,270	15,079	23,156	35,811	41,197	52,775
30	876	1,013	2,054	4,327	7,394	15,336	23,552	36,424	41,901	53,677

The performance specifications are nominal and conform to acceptable industry standards. For applications at conditions beyond these specifications, consult the local Johnson Controls office. Johnson Controls shall not be liable for damages resulting from misapplication or misuse of its products. © 2019 Johnson Controls. www.johnsoncontrols.com

Sizing Water Valves (Continued)



VFX- Series High-Performance Class 300 Butterfly Valves

VFX- Series High-Performance Class 300 Butterfly Valves

	Cv at 60° Open for Modulating Service								
Pipe Size, in.	2-1/2	3	4	5	6	8	10	12	14
Cv	78	123	250	360	530	950	1,200	1,690	1,517
Pressure Drop, psi	Flow Rate, gpm								
1	78	123	250	360	530	950	1,200	1,690	1,517
2	110	174	354	509	750	1,344	1,697	2,390	2,145
3	135	213	433	624	918	1,645	2,078	2,927	2,628
4	156	246	500	720	1,060	1,900	2,400	3,380	3,034
5	174	275	559	805	1,185	2,124	2,683	3,779	3,392
6	191	301	612	882	1,298	2,327	2,939	4,140	3,716
7	206	325	661	952	1,402	2,513	3,175	4,471	4,014
8	221	348	707	1,018	1,499	2,687	3,394	4,780	4,291
9	234	369	750	1,080	1,590	2,850	3,600	5,070	4,551
10	247	389	791	1,138	1,679	3,004	3,795	5,344	4,797
11	259	408	829	1,194	1,758	3,151	3,980	5,605	5,031
12	270	426	866	1,247	1,836	3,291	4,157	5,854	5,255
13	281	443	901	1,298	1,911	3,425	4,327	6,093	5,470
14	292	460	935	1,347	1,983	3,555	4,490	6,323	5,676
15	302	476	968	1,394	2,053	3,679	4,648	6,545	5,875
16	312	492	1000	1,440	2,120	3,800	4,800	6,760	6,068
17	322	507	1030	1,484	2,185	3,917	4,948	6,968	6,255
18	331	522	1061	1,527	2,249	4,031	5,091	7,170	6,436
19	340	536	1090	1,569	2,310	4,141	5,231	7,367	6,612
20	349	550	1118	1,610	2,370	4,249	5,367	7,558	6,784
21	357	564	1146	1,650	2,429	4,353	5,499	7,745	6,952
22	366	577	1173	1,689	2,486	4,456	5,628	7,927	7,115
23	374	590	1199	1,726	2,542	4,556	5,755	8,105	7,275
24	382	603	1225	1,764	2,596	4,654	5,879	8,279	7,432
25	390	615	1250	1,800	2,650	4,750	6,000	8,450	7,585
26	398	627	1275	1,836	2,702	4,844	6,119	8,617	7,735
27	405	639	1299	1,871	2,754	4,936	6,235	8,781	7,883
28	413	651	1323	1,905	2,804	5,027	6,350	8,943	8,027
29	420	662	1346	1,939	2,854	5,116	6,462	9,101	8,169
30	427	674	1369	1,972	2,903	5,203	6,573	9,257	8,309

The performance specifications are nominal and conform to acceptable industry standards. For applications at conditions beyond these specifications, consult the local Johnson Controls office. Johnson Controls shall not be liable for damages resulting from misapplication or misuse of its products. © 2019 Johnson Controls. www.johnsoncontrols.com

Sizing Water Valves (Continued)



VFx-Series High-Performance Class 300 Butterfly Valves

VFx-Series High-Performance Class 300 Butterfly Valves

	Cv at 90° Open for On/Off Service								
Pipe Size, in.	2-1/2	3	4	5	6	8	10	12	14
Cv	160	185	375	790	1,000	2,000	2,650	4,000	3,900
Pressure Drop, psi	Flow Rate, gpm								
1	160	185	375	790	1,000	2,000	2,650	4,000	3,900
2	226	262	530	1,117	1,414	2,828	3,748	5,657	5,515
3	277	320	650	1,368	1,732	3,464	4,590	6,928	6,755
4	320	370	750	1,580	2,000	4,000	5,300	8,000	7,800
5	358	414	839	1,767	2,236	4,472	5,926	8,944	8,721
6	392	453	919	1,935	2,450	4,899	6,491	9,798	9,553
7	423	490	992	2,090	2,646	5,292	7,011	10,583	10,318
8	453	523	1,061	2,235	2,828	5,657	7,495	11,314	11,031
9	480	555	1,125	2,370	3,000	6,000	7,950	12,000	11,700
10	506	585	1,186	2,498	3,162	6,325	8,380	12,649	12,333
11	531	614	1,244	2,620	3,317	6,633	8,789	13,267	12,935
12	554	641	1,299	2,737	3,464	6,928	9,180	13,856	13,510
13	577	667	1,352	2,848	3,606	7,211	9,555	14,422	14,062
14	599	692	1,403	2,956	3,742	7,483	9,915	14,967	14,593
15	620	717	1,452	3,060	3,873	7,746	10,263	15,492	15,105
16	640	740	1,500	3,160	4,000	8,000	10,600	16,000	15,600
17	660	763	1,546	3,257	4,123	8,246	10,926	16,492	16,080
18	679	785	1,591	3,352	4,243	8,485	11,243	16,971	16,546
19	697	806	1,635	3,444	4,359	8,718	11,551	17,436	17,000
20	716	827	1,677	3,533	4,472	8,944	11,851	17,889	17,441
21	733	848	1,719	3,620	4,583	9,165	12,144	18,330	17,872
22	751	868	1,759	3,705	4,690	9,381	12,430	18,762	18,293
23	767	887	1,798	3,789	4,796	9,592	12,709	19,183	18,704
24	784	906	1,837	3,870	4,899	9,798	12,982	19,596	19,106
25	800	925	1,875	3,950	5,000	10,000	13,250	20,000	19,500
26	816	943	1,912	4,028	5,099	10,198	13,512	20,396	19,886
27	831	961	1,949	4,105	5,196	10,392	13,770	20,785	20,265
28	847	979	1,984	4,180	5,292	10,583	14,023	21,166	20,637
29	862	996	2,019	4,254	5,385	10,770	14,271	21,541	21,002
30	876	1,013	2,054	4,327	5,477	10,955	14,515	21,909	21,361

WARNING: BRASS MAY CONTAIN LEAD

To fulfill our obligations towards Article 33, in accordance to the European REACH Regulation No 1907/2006 EC, we hereby inform you that this article contains the following Substances of Very High Concern mentioned on the Candidate list:

- Lead

The performance specifications are nominal and conform to acceptable industry standards. For applications at conditions beyond these specifications, consult the local Johnson Controls office. Johnson Controls shall not be liable for damages resulting from misapplication or misuse of its products. © 2019 Johnson Controls. www.johnsoncontrols.com

Valve Sizing Steam Applications

Two-Position Applications: The valve is normally sized to be the same as the pipe, using the largest Cv available for a given pipe size.

Modulating Applications: Select the valve to meet the BtuH requirements of the coil.

Assumptions:

- The table assumes an atmospheric return.
- Minimum coil BtuH calculated assuming a pressure drop across the valve of 50% of supply pressure.
- Maximum coil BtuH calculated assuming a pressure drop across the valve of 80% of supply pressure.

Steam Sizing

VG1000 Series Ball Valves, Cv 1.2 to 7.4

Available Pipe Size NPT, in.	1/2		1/2		1/2		1/2 3/4		1/2 3/4 1	
	Cv		Cv		Cv		Cv		Cv	
Steam Supply	Coil BtuH		Coil BtuH		Coil BtuH		Coil BtuH		Coil BtuH	
Pressure Drop, psi	Minimum	Maximum	Minimum	Maximum	Minimum	Maximum	Minimum	Maximum	Minimum	Maximum
1	10,700	13,600	17,000	21,500	25,900	32,800	42,000	53,200	66,200	83,700
2	15,600	19,800	24,700	31,300	37,800	47,800	61,200	77,400	96,400	121,900
3	19,600	24,800	31,100	39,300	47,500	60,000	76,900	97,300	121,100	153,200
4	23,300	29,500	36,900	46,700	56,300	71,200	91,200	115,400	143,700	181,700
5	26,700	33,700	42,200	53,400	64,400	81,500	104,400	132,100	164,400	208,000
6	29,900	37,900	47,400	59,900	72,300	91,500	117,200	148,300	184,600	233,400
7	33,000	41,800	52,300	66,100	79,800	100,900	129,300	163,600	203,600	257,600
8	36,100	45,600	57,100	72,200	87,200	110,300	141,300	178,700	222,400	281,400
9	39,000	49,400	61,800	78,200	94,300	119,300	152,900	193,300	240,700	304,400
10	42,000	53,100	66,400	84,000	101,400	128,300	164,300	207,900	258,700	327,300
11	44,800	56,700	71,000	89,800	108,300	137,000	175,600	222,100	276,400	349,600
12	47,600	60,300	75,400	95,400	115,100	145,600	186,600	236,000	293,800	371,600
15	56,000	70,900	88,700	112,200	135,400	171,300	219,500	277,600	345,600	437,100

VG1000 Series Ball Valves, Cv 11.7 to 73.7

Available Pipe Size NPT, in.	1/2 3/4 1		1 1-1/4 1-1/2		1-1/4 1-1/2 2		1-1/2 2		2	
	Cv		Cv		Cv		Cv		Cv	
Steam Supply	Coil BtuH		Coil BtuH		Coil BtuH		Coil BtuH		Coil BtuH	
Pressure Drop, psi	Minimum	Maximum	Minimum	Maximum	Minimum	Maximum	Minimum	Maximum	Minimum	Maximum
1	104,700	132,400	167,300	211,600	261,200	330,400	416,800	527,200	659,200	833,800
2	152,400	192,700	243,500	308,000	380,300	481,000	606,900	767,600	959,800	1,214,100
3	191,500	242,300	306,100	387,200	478,000	604,600	762,800	964,900	1,206,400	1,526,000
4	227,100	287,300	363,000	459,200	566,800	717,000	904,600	1,144,300	1,430,700	1,809,700
5	260,000	328,900	415,600	525,700	648,900	820,800	1,035,600	1,309,900	1,637,800	2,071,700
6	291,800	369,100	466,400	589,900	728,200	921,200	1,162,200	1,470,100	1,838,100	2,325,000
7	322,000	407,300	514,600	650,900	803,500	1,016,400	1,282,400	1,622,100	2,028,100	2,565,400
8	351,700	444,900	562,100	711,000	877,700	1,110,200	1,400,800	1,771,800	2,215,400	2,802,200
9	380,500	481,300	608,200	769,300	949,600	1,201,200	1,515,500	1,917,000	2,396,800	3,031,800
10	409,100	517,500	653,800	827,000	1,021,000	1,291,400	1,629,300	2,061,000	2,576,900	3,259,500
11	437,000	552,800	698,500	883,500	1,090,700	1,379,600	1,740,600	2,201,700	2,752,800	3,482,100
12	464,500	587,500	742,400	939,000	1,159,200	1,466,300	1,850,000	2,340,100	2,925,900	3,700,900
15	546,400	691,100	873,200	1,104,600	1,363,600	1,724,800	2,176,100	2,752,600	3,441,600	4,353,300

The performance specifications are nominal and conform to acceptable industry standards. For applications at conditions beyond these specifications, consult the local Johnson Controls office. Johnson Controls shall not be liable for damages resulting from misapplication or misuse of its products. © 2019 Johnson Controls. www.johnsoncontrols.com

Valve Sizing Steam Applications (Continued)

VG1000 Series Flanged Ball Valves

Available Pipe Size NPT, in.	2-1/2		3		4		5		6	
Cv	47		74		117		176		211	
Steam Supply	Coil BtuH		Coil BtuH		Coil BtuH		Coil BtuH		Coil BtuH	
Pressure Drop, psi	Minimum	Maximum	Minimum	Maximum	Minimum	Maximum	Minimum	Maximum	Minimum	Maximum
1	420,400	531,800	661,900	837,200	1,046,500	1,323,700	1,574,200	1,991,300	1,887,300	2,387,200
2	612,100	774,200	963,700	1,219,000	1,523,700	1,927,300	2,292,000	2,899,200	2,747,800	3,475,800
3	769,400	973,200	1,211,300	1,532,200	1,915,200	2,422,600	2,881,000	3,644,200	3,454,000	4,368,900
4	912,400	1,154,100	1,436,500	1,817,100	2,271,300	2,873,000	3,416,600	4,321,700	4,096,100	5,181,100
5	1,044,500	1,321,200	1,644,500	2,080,100	2,600,100	3,288,800	3,911,200	4,947,300	4,689,000	5,931,200
6	1,172,200	1,482,700	1,845,600	2,334,500	2,918,000	3,691,000	4,389,400	5,552,200	5,262,300	6,656,400
7	1,293,400	1,636,000	2,036,400	2,575,800	3,219,700	4,072,600	4,843,300	6,126,300	5,806,400	7,344,600
8	1,412,800	1,787,000	2,224,400	2,813,600	3,516,900	4,448,600	5,290,400	6,691,900	6,342,500	8,022,700
9	1,528,500	1,933,400	2,406,600	3,044,100	3,805,000	4,813,000	5,723,800	7,240,100	6,862,000	8,679,900
10	1,643,300	2,078,700	2,587,400	3,272,800	4,090,800	5,174,500	6,153,700	7,783,900	7,377,500	9,331,900
11	1,755,500	2,220,600	2,764,000	3,496,200	4,370,100	5,527,800	6,573,900	8,315,400	7,881,200	9,969,000
12	1,865,900	2,360,200	2,937,800	3,716,000	4,644,800	5,875,300	6,987,100	8,838,100	8,376,600	10,595,600
15	2,194,800	2,776,200	3,455,600	4,371,100	5,463,600	6,911,000	8,218,800	10,396,000	9,853,200	12,463,400
20	2,724,500	3,446,300	4,289,700	5,426,100	6,782,400	8,579,100	10,202,500	12,905,300	12,231,500	15,471,700
25	3,245,700	4,105,500	5,110,300	6,464,000	8,079,700	10,220,200	12,154,100	15,373,900	14,571,200	18,431,200

VG2000 Series Cast Iron Flanged Globe Valves

Available Pipe Size NPT, in.	2-1/2		3		4		5		6	
Cv	51		83		150		240		350	
Steam Supply	Coil BtuH		Coil BtuH		Coil BtuH		Coil BtuH		Coil BtuH	
Pressure Drop, psi	Minimum	Maximum	Minimum	Maximum	Minimum	Maximum	Minimum	Maximum	Minimum	Maximum
1	456,200	577,000	742,400	939,100	1,341,700	1,697,100	2,146,700	2,715,400	3,130,600	3,959,900
2	664,200	840,100	1,080,900	1,367,300	1,953,400	2,470,900	3,125,500	3,953,500	4,558,000	5,765,500
3	834,800	1,056,000	1,358,700	1,718,600	2,455,400	3,105,900	3,928,700	4,969,400	5,729,300	7,247,100
4	990,000	1,252,300	1,611,200	2,038,100	2,911,900	3,683,300	4,659,000	5,893,200	6,794,400	8,594,300
5	1,133,400	1,433,600	1,844,500	2,333,100	3,333,400	4,216,500	5,333,500	6,746,300	7,778,000	9,838,400
6	1,271,900	1,608,900	2,070,000	2,618,400	3,741,000	4,732,000	5,985,600	7,571,200	8,729,000	11,041,400
7	1,403,400	1,775,200	2,284,000	2,889,100	4,127,800	5,221,300	6,604,500	8,354,000	9,631,500	12,183,000
8	1,533,000	1,939,100	2,494,900	3,155,800	4,508,900	5,703,300	7,214,200	9,125,300	10,520,700	13,307,800
9	1,658,600	2,098,000	2,699,300	3,414,300	4,878,200	6,170,500	7,805,100	9,872,800	11,382,500	14,397,900
10	1,783,200	2,255,600	2,902,000	3,670,800	5,244,700	6,634,000	8,391,400	10,614,400	12,237,500	15,479,400
11	1,904,900	2,409,600	3,100,200	3,921,500	5,602,700	7,087,000	8,964,400	11,339,100	13,073,000	16,536,200
12	2,024,700	2,561,000	3,295,100	4,168,000	5,954,900	7,532,400	9,527,900	12,051,900	13,894,800	17,575,700
15	2,381,600	3,012,500	3,875,900	4,902,700	7,004,600	8,860,200	11,207,400	14,176,400	16,344,200	20,673,900
20	2,956,400	3,739,600	4,811,400	6,086,000	8,695,400	10,998,800	13,912,600	17,598,200	20,289,200	25,664,000
25	3,521,900	4,454,900	5,731,800	7,250,200	10,358,600	13,102,800	16,573,800	20,964,400	24,170,200	30,573,100
30	4,077,600	5,157,800	6,636,100	8,394,000	11,992,900	15,170,000	19,188,600	24,271,900	27,983,400	35,396,600
35	4,623,800	5,848,600	7,524,900	9,518,400	13,599,300	17,201,900	21,758,900	27,523,000	31,731,700	40,137,800

The performance specifications are nominal and conform to acceptable industry standards. For applications at conditions beyond these specifications, consult the local Johnson Controls office. Johnson Controls shall not be liable for damages resulting from misapplication or misuse of its products. © 2019 Johnson Controls. www.johnsoncontrols.com

Valve Sizing Steam Applications (Continued)

VG7000 Series Bronze Globe Valves, Cv 0.73 to 7.3

Available Pipe Size NPT, in.	1/2		1/2		1/2		3/4	
	0.73		1.8		4.6		7.3	
Steam Supply ¹	Coil BtuH		Coil BtuH		Coil BtuH		Coil BtuH	
Pressure Drop, psi	Minimum	Maximum	Minimum	Maximum	Minimum	Maximum	Minimum	Maximum
1	6,500	8,300	16,100	20,400	41,100	52,000	65,300	82,600
2	9,500	12,000	23,400	29,700	59,900	75,800	95,100	120,300
3	11,900	15,100	29,500	37,300	75,300	95,200	119,500	151,200
4	14,200	17,900	34,900	44,200	89,300	113,000	141,700	179,300
5	16,200	20,500	40,000	50,600	102,200	129,300	162,200	205,200
6	18,200	23,000	44,900	56,800	114,700	145,100	182,100	230,300
7	20,100	25,400	49,500	62,700	126,600	160,100	200,900	254,100
8	21,900	27,800	54,100	68,400	138,300	174,900	219,400	277,600
9	23,700	30,000	58,500	74,000	149,600	189,200	237,400	300,300
10	25,500	32,300	62,900	79,600	160,800	203,400	255,200	322,900
11	27,300	34,500	67,200	85,000	171,800	217,300	272,700	344,900
12	29,000	36,700	71,500	90,400	182,600	231,000	289,800	366,600
15	34,100	43,100	84,100	106,300	214,800	271,700	340,900	431,200
20	42,400	53,000	104,600	130,800	267,400	334,200	424,400	530,300
25	50,400	60,300	124,300	148,600	317,700	379,800	504,100	602,700
30	58,400	67,600	143,900	166,700	367,800	425,900	583,700	675,900
35	66,200	74,800	163,200	184,500	417,000	471,500	661,800	748,200
40	69,800	77,400	172,100	190,900	439,800	487,900	698,000	774,400
45	81,900	89,500	201,900	220,600	516,000	563,900	818,900	894,800
50	89,700	96,800	221,100	238,600	565,000	609,700	896,600	967,600
55	97,400	104,000	240,100	256,500	613,700	655,400	973,900	1,040,100
60	105,100	111,200	259,100	274,300	662,200	701,000	1,050,900	1,112,400
65	112,800	118,500	278,100	292,200	710,700	746,600	1,127,900	1,184,800
70	120,500	125,700	297,100	310,000	759,300	792,300	1,204,900	1,257,400
75	128,100	132,900	315,900	327,700	807,200	837,500	1,281,000	1,329,000
80	135,800	140,200	334,800	345,600	855,700	883,200	1,357,900	1,401,600
85	143,400	147,300	353,500	363,200	903,300	928,100	1,433,600	1,472,900
90	151,000	154,500	372,400	381,000	951,700	973,800	1,510,200	1,545,300
95	158,600	161,600	390,900	398,500	999,100	1,018,500	1,585,500	1,616,300
100	166,200	168,900	409,800	416,400	1,047,400	1,064,200	1,662,200	1,688,800

1. For steam pressures greater than 38 psig, VG7243 or VG7443 (stainless steel trim valve) is required. Refer to the *VG7000 Series Bronze Control Valves Product Bulletin (LIT-977140)* for ordering information.

Valve Sizing Steam Applications (Continued)

VG7000 Series Bronze Globe Valves, Cv 11.6 to 46.2

Available Pipe Size NPT, in.	1		1-1/4		1-1/2		2	
Cv	11.6		18.5		29.9		46.2	
Steam Supply ¹	Coil BtuH		Coil BtuH		Coil BtuH		Coil BtuH	
Pressure Drop, psi	Minimum	Maximum	Minimum	Maximum	Minimum	Maximum	Minimum	Maximum
1	103,800	131,200	165,500	209,300	267,400	338,300	413,200	522,700
2	151,100	191,100	240,900	304,700	389,400	492,500	601,700	761,000
3	189,900	240,200	302,800	383,100	489,400	619,100	756,300	956,600
4	225,200	284,800	359,100	454,300	580,400	734,200	896,900	1,134,400
5	257,800	326,100	411,100	520,000	664,500	840,500	1,026,700	1,298,700
6	289,300	365,900	461,400	583,600	745,700	943,300	1,152,200	1,457,500
7	319,200	403,800	509,100	644,000	822,800	1,040,800	1,271,400	1,608,200
8	348,700	441,100	556,100	703,400	898,800	1,136,900	1,388,700	1,756,600
9	377,200	477,200	601,600	761,000	972,400	1,230,000	1,502,500	1,900,500
10	405,600	513,000	646,800	818,200	1,045,400	1,322,400	1,615,400	2,043,300
11	433,300	548,100	691,000	874,100	1,116,800	1,412,700	1,725,600	2,182,800
12	460,500	582,500	734,400	929,000	1,187,000	1,501,500	1,834,100	2,320,000
15	541,700	685,200	863,900	1,092,800	1,396,300	1,766,100	2,157,400	2,729,000
20	674,400	842,700	1,075,500	1,344,000	1,738,300	2,172,200	2,685,900	3,356,300
25	801,100	957,700	1,277,600	1,527,300	2,064,800	2,468,500	3,190,500	3,814,200
30	927,500	1,074,000	1,479,100	1,712,800	2,390,600	2,768,300	3,693,800	4,277,500
35	1,051,700	1,188,900	1,677,200	1,896,100	2,710,800	3,064,500	4,188,600	4,735,100
40	1,109,100	1,230,500	1,768,900	1,962,400	2,858,900	3,171,700	4,417,500	4,900,700
45	1,301,300	1,421,900	2,075,400	2,267,700	3,354,200	3,665,200	5,182,800	5,663,200
50	1,424,800	1,537,600	2,272,200	2,452,100	3,672,400	3,963,200	5,674,500	6,123,700
55	1,547,600	1,652,800	2,468,100	2,635,900	3,989,000	4,260,100	6,163,600	6,582,500
60	1,669,900	1,767,700	2,663,200	2,819,100	4,304,400	4,556,300	6,650,900	7,040,200
65	1,792,300	1,882,800	2,858,300	3,002,700	4,619,700	4,853,000	7,138,100	7,498,600
70	1,914,700	1,998,100	3,053,600	3,186,600	4,935,200	5,150,200	7,625,700	7,957,800
75	2,035,500	2,111,900	3,246,300	3,368,000	5,246,800	5,443,500	8,107,000	8,411,000
80	2,157,800	2,227,200	3,441,300	3,552,000	5,561,900	5,740,800	8,594,000	8,870,400
85	2,278,000	2,340,500	3,633,000	3,732,700	5,871,800	6,032,900	9,072,800	9,321,800
90	2,399,800	2,455,600	3,827,300	3,916,200	6,185,800	6,329,500	9,558,000	9,780,000
95	2,519,400	2,568,400	4,018,100	4,096,200	6,494,100	6,620,300	10,034,300	10,229,400
100	2,641,300	2,683,600	4,212,300	4,279,800	6,808,100	6,917,100	10,519,500	10,688,000

1. For steam pressures greater than 38 psig, VG7243 or VG7443 (stainless steel trim valve) is required. Refer to the VG7000 Series Bronze Control Valves Product Bulletin (LIT-977140) for ordering information.

JS Series Two-Position On/Off Electric Zone Valves

Available Pipe Size NPT, in.	1/2	1/2 3/4	1/2 3/4	1 1-1/4
Cv	1.0	2.5	3.5	8.0
Steam Supply	Maximum Coil BtuH		Maximum Coil BtuH	Maximum Coil BtuH
Pressure Drop, psi				
1	11,310	28,280	39,600	90,510
2	16,470	41,180	57,660	131,780
3	20,710	51,760	72,470	165,650
4	24,560	61,390	85,940	196,440
5	28,110	70,270	98,380	224,880
6	31,550	78,870	110,410	252,370
7	34,810	87,020	121,830	278,470
8	38,020	95,060	133,080	304,180
9	41,140	102,840	143,980	329,090
10	44,230	110,570	154,790	353,810
11	47,250	118,120	165,360	377,970
12	50,220	125,540	175,760	401,730
15	59,070	147,670	206,740	472,550

Cross-Reference of VT Series Threaded (NPT) Valves to VG7000 Series Valves

VT Series Threaded (NPT) Valve	VG7000 Series Equivalent
VTM-TC007 (Slotted Stem)	VG7441Cx
VTM-TC007-012	VG7441CT Plus VG7000-1001
VTM-TC007-013	VG7441CT Plus VG7000-1002
VTM-TC007-014	VG7441CT Plus VG7000-1003
VTM-TC007-020	VG7441CT
VTM-TC007-094	VG7441CT Plus VG7000-1012
VTM-TC007-312	VG7441CT+3008B
VTM-TC007-313	VG7441CT+3008D
VTM-TC007-314	VG7441CT+3008E
VTM-TC007-322	VG7441CT+3003B
VTM-TC007-323	VG7441CT+3003D
VTM-TC007-324	VG7441CT+3003E
VTM-TC007-394	VG7441CS+3801E
VTM-TC007-3P4	VG7441CT+3008EP
VTM-TC007-413	VG7441CS+3801D
VTM-TC007-414	VG7441CS+3801E
VTM-TC007-520	VG7441CT+423GGA
VTM-TC019 (Slotted Stem)	VG7441Ex
VTM-TC019-012	VG7441ET Plus VG7000-1001
VTM-TC019-013	VG7441ET Plus VG7000-1002
VTM-TC019-014	VG7441ET Plus VG7000-1003
VTM-TC019-020	VG7441ET
VTM-TC019-094	VG7441ET Plus VG7000-1012
VTM-TC019-312	VG7441ET+3008B
VTM-TC019-313	VG7441ET+3008D
VTM-TC019-314	VG7441ET+3008E
VTM-TC019-322	VG7441ET+3003B
VTM-TC019-323	VG7441ET+3003D
VTM-TC019-324	VG7441ET+3003E
VTM-TC019-394	VG7441ES+3801E
VTM-TC019-3P4	VG7441ET+3008EP
VTM-TC019-413	VG7441ES+3801D
VTM-TC019-414	VG7441ES+3801E
VTM-TC019-520	VG7441ET+423GGA
VTM-TC047 (Slotted Stem)	VG7441Gx
VTM-TC047-012	VG7441GT Plus VG7000-1001
VTM-TC047-013	VG7441GT Plus VG7000-1002
VTM-TC047-014	VG7441GT Plus VG7000-1003
VTM-TC047-020	VG7441GT

VT Series Threaded (NPT) Valve	VG7000 Series Equivalent
VTM-TC047-094	VG7441GT Plus VG7000-1012
VTM-TC047-312	VG7441GT+3008B
VTM-TC047-313	VG7441GT+3008D
VTM-TC047-314	VG7441GT+3008E
VTM-TC047-322	VG7441GT+3003B
VTM-TC047-323	VG7441GT+3003D
VTM-TC047-324	VG7441GT+3003E
VTM-TC047-394	VG7441GS+3801E
VTM-TC047-3P4	VG7441GT+3008EP
VTM-TC047-413	VG7441GS+3801D
VTM-TC047-414	VG7441GS+3801E
VTM-TC047-520	VG7441GT+423GGA
VTM-TM007 (Slotted Stem)	VG7842Cx
VTM-TM007-012	VG7842CT Plus VG7000-1001
VTM-TM007-013	VG7842CT Plus VG7000-1002
VTM-TM007-014	VG7842CT Plus VG7000-1003
VTM-TM007-020	VG7842CT
VTM-TM007-094	VG7842CT Plus VG7000-1012
VTM-TM007-200	VG7842CS+8020G
VTM-TM007-220	VG7842CS+8022G
VTM-TM007-312	VG7842CT+3008B
VTM-TM007-313	VG7842CT+3008D
VTM-TM007-314	VG7842CT+3008E
VTM-TM007-322	VG7842CT+3003B
VTM-TM007-323	VG7842CT+3003D
VTM-TM007-324	VG7842CT+3003E
VTM-TM007-3P3	VG7842CT+3008DP
VTM-TM007-413	VG7842CS+3801D
VTM-TM007-414	VG7842CS+3801E
VTM-TM007-500	VG7842CT+8050G
VTM-TM007-510	VG7842CT+8051G
VTM-TM007-520	VG7842CT+8052G
VTM-TM007-700	VG7842CT+7150G
VTM-TM007-720	VG7842CT+7152G
VTM-TM007-730	VG7842CT+7153G
VTM-TM019 (Slotted Stem)	VG7842Ex
VTM-TM019-012	VG7842ET Plus VG7000-1001
VTM-TM019-013	VG7842ET Plus VG7000-1002
VTM-TM019-014	VG7842ET Plus VG7000-1003
VTM-TM019-020	VG7842ET
VTM-TM019-094	VG7842ET Plus VG7000-1012

VT Series Threaded (NPT) Valve	VG7000 Series Equivalent
VTM-TM019-200	VG7842ES+8020G
VTM-TM019-220	VG7842ES+8022G
VTM-TM019-312	VG7842ET+3008B
VTM-TM019-313	VG7842ET+3008D
VTM-TM019-314	VG7842ET+3008E
VTM-TM019-322	VG7842ET+3003B
VTM-TM019-323	VG7842ET+3003D
VTM-TM019-324	VG7842ET+3003E
VTM-TM019-394	VG7842ES+3801E
VTM-TM019-3P3	VG7842ET+3008DP
VTM-TM019-413	VG7842ES+3801D
VTM-TM019-414	VG7842ES+3801E
VTM-TM019-500	VG7842ET+8050G
VTM-TM019-510	VG7842ET+8051G
VTM-TM019-520	VG7842ET+7152G
VTM-TM019-700	VG7842ET+7150G
VTM-TM019-720	VG7842ET+7152G
VTM-TM019-730	VG7842ET+7153G
VTM-TM047 (Slotted Stem)	VG7842Gx
VTM-TM047-012	VG7842GT Plus VG7000-1001
VTM-TM047-013	VG7842GT Plus VG7000-1002
VTM-TM047-014	VG7842GT Plus VG7000-1003
VTM-TM047-020	VG7842GT
VTM-TM047-094	VG7842GT Plus VG7000-1012
VTM-TM047-200	VG7842GS+8020G
VTM-TM047-220	VG7842GS+8022G
VTM-TM047-312	VG7842GT+3008B
VTM-TM047-313	VG7842GT+3008D
VTM-TM047-314	VG7842GT+3008E
VTM-TM047-322	VG7842GT+3003B
VTM-TM047-323	VG7842GT+3003D
VTM-TM047-324	VG7842GT+3003E
VTM-TM047-394	VG7842GS+3801E
VTM-TM047-3P3	VG7842GT+3008DP
VTM-TM047-413	VG7842GS+3801D
VTM-TM047-414	VG7842GS+3801E
VTM-TM047-500	VG7842GT+8050G
VTM-TM047-510	VG7842GT+8051G
VTM-TM047-520	VG7842GT+7152G
VTM-TM047-700	VG7842GT+7150G
VTM-TM047-720	VG7842GT+7152G
VTM-TM047-730	VG7842GT+7153G

Cross-Reference of VT Series Threaded (NPT) Valves to VG7000 Series Valves (Continued)

VT Series Threaded (NPT) Valve	VG7000 Series Equivalent
VTM-TN007 (Slotted Stem)	VG7241Cx
VTM-TN007-012	VG7241CT Plus VG7000-1001
VTM-TN007-013	VG7241CT Plus VG7000-1002
VTM-TN007-014	VG7241CT Plus VG7000-1003
VTM-TN007-020	VG7241CT
VTM-TN007-093	VG7241CT Plus VG7000-1011
VTM-TN007-094	VG7241CT Plus VG7000-1012
VTM-TN007-200	VG7241CS+8020G
VTM-TN007-220	VG7241CS+8022G
VTM-TN007-312	VG7241CT+3008B
VTM-TN007-313	VG7241CT+3008D
VTM-TN007-314	VG7241CT+3008E
VTM-TN007-322	VG7241CT+3003B
VTM-TN007-323	VG7241CT+3003D
VTM-TN007-324	VG7241CT+3003E
VTM-TN007-392	VG7241CS+3801B
VTM-TN007-393	VG7241CS+3801D
VTM-TN007-394	VG7241CS+3801E
VTM-TN007-3P2	VG7241CT+3008BP
VTM-TN007-412	VG7241CS+3801B
VTM-TN007-413	VG7241CS+3801D
VTM-TN007-414	VG7241CS+3801E
VTM-TN007-500	VG7241CT+8050G
VTM-TN007-510	VG7241CT+8051G
VTM-TN007-520	VG7241CT+7152G
VTM-TN007-700	VG7241CT+7150G
VTM-TN007-720	VG7241CT+7152G
VTM-TN007-730	VG7241CT+7153G

VT Series Threaded (NPT) Valve	VG7000 Series Equivalent
VTM-TN019 (Slotted Stem)	VG7241Ex
VTM-TN019-012	VG7241ET Plus VG7000-1001
VTM-TN019-013	VG7241ET Plus VG7000-1002
VTM-TN019-014	VG7241ET Plus VG7000-1003
VTM-TN019-020	VG7241ET
VTM-TN019-092	VG7241ET Plus VG7000-1010
VTM-TN019-093	VG7241ET Plus VG7000-1011
VTM-TN019-094	VG7241ET Plus VG7000-1012
VTM-TN019-200	VG7241ES+8020G
VTM-TN019-220	VG7241ES+8022G
VTM-TN019-312	VG7241ET+3008B
VTM-TN019-313	VG7241ET+3008D
VTM-TN019-314	VG7241ET+3008E
VTM-TN019-322	VG7241ET+3003B
VTM-TN019-323	VG7241ET+3003D
VTM-TN019-324	VG7241ET+3003E
VTM-TN019-392	VG7241ES+3801B
VTM-TN019-393	VG7241ES+3801D
VTM-TN019-394	VG7241ES+3801E
VTM-TN019-3P2	VG7241ET+3008BP
VTM-TN019-412	VG7241ES+3801B
VTM-TN019-413	VG7241ES+3801D
VTM-TN019-414	VG7241ES+3801E
VTM-TN019-500	VG7241ET+8050G
VTM-TN019-510	VG7241ET+8051G
VTM-TN019-520	VG7241ET+7152G
VTM-TN019-700	VG7241ET+7150G
VTM-TN019-720	VG7241ET+7152G
VTM-TN019-730	VG7241ET+7153G

VT Series Threaded (NPT) Valve	VG7000 Series Equivalent
VTM-TN047 (Slotted Stem)	VG7241Gx
VTM-TN047-012	VG7241GT Plus VG7000-1001
VTM-TN047-013	VG7241GT Plus VG7000-1002
VTM-TN047-014	VG7241GT Plus VG7000-1003
VTM-TN047-020	VG7241GT
VTM-TN047-092	VG7241GT Plus VG7000-1010
VTM-TN047-093	VG7241GT Plus VG7000-1011
VTM-TN047-094	VG7241GT Plus VG7000-1012
VTM-TN047-200	VG7241GS+8020G
VTM-TN047-220	VG7241GS+8022G
VTM-TN047-312	VG7241GT+3008B
VTM-TN047-313	VG7241GT+3008D
VTM-TN047-314	VG7241GT+3008E
VTM-TN047-322	VG7241GT+3003B
VTM-TN047-323	VG7241GT+3003D
VTM-TN047-324	VG7241GT+3003E
VTM-TN047-392	VG7241GS+3801B
VTM-TN047-393	VG7241GS+3801D
VTM-TN047-394	VG7241GS+3801E
VTM-TN047-3P2	VG7241GT+3008BP
VTM-TN047-412	VG7241GS+3801B
VTM-TN047-413	VG7241GS+3801D
VTM-TN047-414	VG7241GS+3801E
VTM-TN047-500	VG7241GT+8050G
VTM-TN047-510	VG7241GT+8051G
VTM-TN047-520	VG7241GT+7152G
VTM-TN047-700	VG7241GT+7150G
VTM-TN047-720	VG7241GT+7152G
VTM-TN047-730	VG7241GT+7153G



WARNING This product is made of copper alloy, which contains lead. The product is therefore not to be used on drinking water.



WARNING This product can expose you to chemicals including lead, which is known to the State of California to cause cancer, birth defects, or other reproductive harm. For more information, go to www.P65Warnings.ca.gov.

WARNING: BRASS MAY CONTAIN LEAD

To fulfill our obligations towards Article 33, in accordance to the European REACH Regulation No 1907/2006 EC, we hereby inform you that this article contains the following Substances of Very High Concern mentioned on the Candidate list:

- Lead

Cross-Reference of VT Series Union End Valves to VG7000 Series Valves

VT Series Union End Valve	VG7000 Series Equivalent
VTM-AN007 (Slotted Stem)	VG7551Cx
VTM-AN007-012	VG7551CT Plus VG7000-1001
VTM-AN007-013	VG7551CT Plus VG7000-1002
VTM-AN007-014	VG7551CT Plus VG7000-1003
VTM-AN007-020	VG7551CT
VTM-AN007-092	VG7551CT Plus VG7000-1010
VTM-AN007-093	VG7551CT Plus VG7000-1011
VTM-AN007-094	VG7551CT Plus VG7000-1012
VTM-AN007-200	VG7551CS+8020G
VTM-AN007-220	VG7551CS+8022G
VTM-AN007-312	VG7551CT+3008B
VTM-AN007-313	VG7551CT+3008D
VTM-AN007-314	VG7551CT+3008E
VTM-AN007-322	VG7551CT+3003B
VTM-AN007-323	VG7551CT+3003D
VTM-AN007-324	VG7551CT+3003E
VTM-AN007-392	VG7551CS+3801B
VTM-AN007-393	VG7551CS+3801D
VTM-AN007-394	VG7551CS+3801E
VTM-AN007-3P2	VG7551CT+3008BP
VTM-AN007-412	VG7551CS+3801B
VTM-AN007-413	VG7551CS+3801D
VTM-AN007-414	VG7551CS+3801E
VTM-AN007-500	VG7551CT+8050G
VTM-AN007-510	VG7551CT+8051G
VTM-AN007-520	VG7551CT+7152G
VTM-AN007-700	VG7551CT+7150G
VTM-AN007-720	VG7551CT+7152G
VTM-AN007-730	VG7551CT+7153G
VTM-AN019 (Slotted Stem)	VG7551Ex
VTM-AN019-012	VG7551ET Plus VG7000-1001
VTM-AN019-013	VG7551ET Plus VG7000-1002
VTM-AN019-014	VG7551ET Plus VG7000-1003
VTM-AN019-020	VG7551ET
VTM-AN019-092	VG7551ET Plus VG7000-1010
VTM-AN019-093	VG7551ET Plus VG7000-1011
VTM-AN019-094	VG7551ET Plus VG7000-1012
VTM-AN019-200	VG7551ES+8020G
VTM-AN019-220	VG7551ES+8022G
VTM-AN019-312	VG7551ET+3008B

VT Series Union End Valve	VG7000 Series Equivalent
VTM-AN019-313	VG7551ET+3008D
VTM-AN019-314	VG7551ET+3008E
VTM-AN019-322	VG7551ET+3003B
VTM-AN019-323	VG7551ET+3003D
VTM-AN019-324	VG7551ET+3003E
VTM-AN019-392	VG7551ES+3801B
VTM-AN019-393	VG7551ES+3801D
VTM-AN019-394	VG7551ES+3801E
VTM-AN019-3P2	VG7551ET+3008BP
VTM-AN019-412	VG7551ES+3801B
VTM-AN019-413	VG7551ES+3801D
VTM-AN019-414	VG7551ES+3801E
VTM-AN019-500	VG7551ET+8050G
VTM-AN019-510	VG7551ET+8051G
VTM-AN019-520	VG7551ET+7152G
VTM-AN019-700	VG7551ET+7150G
VTM-AN019-720	VG7551ET+7152G
VTM-AN019-730	VG7551ET+7153G
VTM-AN047 (Slotted Stem)	VG7551Gx
VTM-AN047-012	VG7551GT Plus VG7000-1001
VTM-AN047-013	VG7551GT Plus VG7000-1002
VTM-AN047-014	VG7551GT Plus VG7000-1003
VTM-AN047-020	VG7551GT
VTM-AN047-092	VG7551GT Plus VG7000-1010
VTM-AN047-093	VG7551GT Plus VG7000-1011
VTM-AN047-094	VG7551GT Plus VG7000-1012
VTM-AN047-200	VG7551GS+8020G
VTM-AN047-220	VG7551GS+8022G
VTM-AN047-312	VG7551GT+3008B
VTM-AN047-313	VG7551GT+3008D
VTM-AN047-314	VG7551GT+3008E
VTM-AN047-322	VG7551GT+3003B
VTM-AN047-323	VG7551GT+3003D
VTM-AN047-324	VG7551GT+3003E
VTM-AN047-392	VG7551GS+3801B
VTM-AN047-393	VG7551GS+3801D
VTM-AN047-394	VG7551GS+3801E
VTM-AN047-3P2	VG7551GT+3008BP
VTM-AN047-412	VG7551GS+3801B
VTM-AN047-413	VG7551GS+3801D
VTM-AN047-414	VG7551GS+3801E
VTM-AN047-500	VG7551GT+8050G
VTM-AN047-510	VG7551GT+8051G
VTM-AN047-520	VG7551GT+7152G
VTM-AN047-700	VG7551GT+7150G
VTM-AN047-720	VG7551GT+7152G
VTM-AN047-730	VG7551GT+7153G

VT Series Union End Valve	VG7000 Series Equivalent
VTM-GC007 (Slotted Stem)	VG7451Cx
VTM-GC007-012	VG7451CT Plus VG7000-1001
VTM-GC007-013	VG7451CT Plus VG7000-1002
VTM-GC007-014	VG7451CT Plus VG7000-1003
VTM-GC007-020	VG7451CT
VTM-GC007-094	VG7451CT Plus VG7000-1012
VTM-GC007-312	VG7451CT+3008B
VTM-GC007-313	VG7451CT+3008D
VTM-GC007-314	VG7451CT+3008E
VTM-GC007-322	VG7451CT+3003B
VTM-GC007-323	VG7451CT+3003D
VTM-GC007-324	VG7451CT+3003E
VTM-GC007-394	VG7451CS+3801E
VTM-GC007-3P4	VG7451CT+3008EP
VTM-GC007-413	VG7451CS+3801D
VTM-GC007-414	VG7451CS+3801E
VTM-GC007-520	VG7451CT+7152G
VTM-GC019 (Slotted Stem)	VG7451Ex
VTM-GC019-012	VG7451ET Plus VG7000-1001
VTM-GC019-013	VG7451ET Plus VG7000-1002
VTM-GC019-014	VG7451ET Plus VG7000-1003
VTM-GC019-020	VG7451ET
VTM-GC019-094	VG7451ET Plus VG7000-1012
VTM-GC019-312	VG7451ET+3008B
VTM-GC019-313	VG7451ET+3008D
VTM-GC019-314	VG7451ET+3008E
VTM-GC019-322	VG7451ET+3003B
VTM-GC019-323	VG7451ET+3003D
VTM-GC019-324	VG7451ET+3003E
VTM-GC019-394	VG7451ES+3801E
VTM-GC019-3P4	VG7451ET+3008EP
VTM-GC019-413	VG7451ES+3801D
VTM-GC019-414	VG7451ES+3801E
VTM-GC019-520	VG7451ET+7152G
VTM-GC047 (Slotted Stem)	VG7451Gx
VTM-GC047-012	VG7451GT Plus VG7000-1001
VTM-GC047-013	VG7451GT Plus VG7000-1002
VTM-GC047-014	VG7451GT Plus VG7000-1003
VTM-GC047-020	VG7451GT
VTM-GC047-094	VG7451GT Plus VG7000-1012

Cross-Reference of VT Series Union End Valves to VG7000 Series Valves (Continued)

VT Series Union End Valve	VG7000 Series Equivalent
VTM-GC047-312	VG7451GT+3008B
VTM-GC047-313	VG7451GT+3008D
VTM-GC047-314	VG7451GT+3008E
VTM-GC047-322	VG7451GT+3003B
VTM-GC047-323	VG7451GT+3003D
VTM-GC047-324	VG7451GT+3003E
VTM-GC047-394	VG7451GS+3801E
VTM-GC047-3P4	VG7451GT+3008EP
VTM-GC047-413	VG7451GS+3801D
VTM-GC047-414	VG7451GS+3801E
VTM-GC047-520	VG7451GT+7152G
VTM-GN007 (Slotted Stem)	VG7251Cx
VTM-GN007-012	VG7251CT Plus VG7000-1001
VTM-GN007-013	VG7251CT Plus VG7000-1002
VTM-GN007-014	VG7251CT Plus VG7000-1003
VTM-GN007-020	VG7251CT
VTM-GN007-092	VG7251CT Plus VG7000-1010
VTM-GN007-093	VG7251CT Plus VG7000-1011
VTM-GN007-094	VG7251CT Plus VG7000-1012
VTM-GN007-200	VG7251CS+8020G
VTM-GN007-220	VG7251CS+8022G
VTM-GN007-312	VG7251CT+3008B
VTM-GN007-313	VG7251CT+3008D
VTM-GN007-314	VG7251CT+3008E
VTM-GN007-322	VG7251CT+3003B
VTM-GN007-323	VG7251CT+3003D
VTM-GN007-324	VG7251CT+3003E
VTM-GN007-392	VG7251CS+3801B
VTM-GN007-393	VG7251CS+3801D
VTM-GN007-394	VG7251CS+3801E
VTM-GN007-3P2	VG7251CT+3008BP
VTM-GN007-412	VG7251CS+3801B
VTM-GN007-413	VG7251CS+3801D
VTM-GN007-414	VG7251CS+3801E
VTM-GN007-500	VG7251CT+8050G
VTM-GN007-510	VG7251CT+8051G
VTM-GN007-520	VG7251CT+7152G
VTM-GN007-700	VG7251CT+7150G
VTM-GN007-720	VG7251CT+7152G
VTM-GN007-730	VG7251CT+7153G
VTM-GN019 (Slotted Stem)	VG7251Ex
VTM-GN019-012	VG7251ET Plus VG7000-1001
VTM-GN019-013	VG7251ET Plus VG7000-1002
VTM-GN019-014	VG7251ET Plus VG7000-1003

VT Series Union End Valve	VG7000 Series Equivalent
VTM-GN019-020	VG7251ET
VTM-GN019-092	VG7251ET Plus VG7000-1010
VTM-GN019-093	VG7251ET Plus VG7000-1011
VTM-GN019-094	VG7251ET Plus VG7000-1012
VTM-GN019-200	VG7251ES+8020G
VTM-GN019-220	VG7251ES+8022G
VTM-GN019-312	VG7251ET+3008B
VTM-GN019-313	VG7251ET+3008D
VTM-GN019-314	VG7251ET+3008E
VTM-GN019-322	VG7251ET+3003B
VTM-GN019-323	VG7251ET+3003D
VTM-GN019-324	VG7251ET+3003E
VTM-GN019-392	VG7251ES+3801B
VTM-GN019-393	VG7251ES+3801D
VTM-GN019-394	VG7251ES+3801E
VTM-GN019-3P2	VG7251ET+3008BP
VTM-GN019-412	VG7251ES+3801B
VTM-GN019-413	VG7251ES+3801D
VTM-GN019-414	VG7251ES+3801E
VTM-GN019-500	VG7251ET+8050G
VTM-GN019-510	VG7251ET+8051G
VTM-GN019-520	VG7251ET+7152G
VTM-GN019-700	VG7251ET+7150G
VTM-GN019-710	VG7251ET+7152G
VTM-GN019-720	VG7251ET+7153G
VTM-GN047 (Slotted Stem)	VG7251Gx
VTM-GN047-012	VG7251GT Plus VG7000-1001
VTM-GN047-013	VG7251GT Plus VG7000-1002
VTM-GN047-014	VG7251GT Plus VG7000-1003
VTM-GN047-020	VG7251GT
VTM-GN047-092	VG7251GT Plus VG7000-1010
VTM-GN047-093	VG7251GT Plus VG7000-1011
VTM-GN047-314	VG7251GT+3008E
VTM-GN047-322	VG7251GT+3003B
VTM-GN047-323	VG7251GT+3003D
VTM-GN047-324	VG7251GT+3003E
VTM-GN047-392	VG7251GS+3801B
VTM-GN047-393	VG7251GS+3801D
VTM-GN047-394	VG7251GS+3801E
VTM-GN047-3P2	VG7251GT+3008BP
VTM-GN047-412	VG7251GS+3801B
VTM-GN047-413	VG7251GS+3801D
VTM-GN047-414	VG7251GS+3801E
VTM-GN047-500	VG7251GT+8050G
VTM-GN047-510	VG7251GT+8051G
VTM-GN047-520	VG7251GT+7152G

VT Series Union End Valve	VG7000 Series Equivalent
VTM-GN047-700	VG7251GT+7150G
VTM-GN047-720	VG7251GT+7152G
VTM-GN047-730	VG7251GT+7153G
VTM-UC007 (Slotted Stem)	VG7481Cx
VTM-UC007-012	VG7481CT Plus VG7000-1001
VTM-UC007-013	VG7481CT Plus VG7000-1002
VTM-UC007-014	VG7481CT Plus VG7000-1003
VTM-UC007-020	VG7481CT
VTM-UC007-094	VG7481CT Plus VG7000-1012
VTM-UC007-312	VG7481CT+3008B
VTM-UC007-313	VG7481CT+3008D
VTM-UC007-314	VG7481CT+3008E
VTM-UC007-322	VG7481CT+3003B
VTM-UC007-323	VG7481CT+3003D
VTM-UC007-324	VG7481CT+3003E
VTM-UC007-394	VG7481CS+3801E
VTM-UC007-3P4	VG7481CT+3008EP
VTM-UC007-413	VG7481CS+3801D
VTM-UC007-414	VG7481CS+3801E
VTM-UC007-520	VG7481CT+7152G
VTM-UC019 (Slotted Stem)	VG7481Ex
VTM-UC019-012	VG7481ET Plus VG7000-1001
VTM-UC019-013	VG7481ET Plus VG7000-1002
VTM-UC019-014	VG7481ET Plus VG7000-1003
VTM-UC019-020	VG7481ET
VTM-UC019-094	VG7481ET Plus VG7000-1012
VTM-UC019-312	VG7481ET+3008B
VTM-UC019-313	VG7481ET+3008D
VTM-UC019-314	VG7481ET+3008E
VTM-UC019-322	VG7481ET+3003B
VTM-UC019-323	VG7481ET+3003D
VTM-UC019-324	VG7481ET+3003E
VTM-UC019-394	VG7481ES+3801E
VTM-UC019-3P4	VG7481ET+3008EP
VTM-UC019-413	VG7481ES+3801D
VTM-UC019-414	VG7481ES+3801E
VTM-UC019-520	VG7481ET+7152G
VTM-UC047 (Slotted Stem)	VG7481Gx
VTM-UC047-012	VG7481GT Plus VG7000-1001
VTM-UC047-013	VG7481GT Plus VG7000-1002
VTM-UC047-014	VG7481GT Plus VG7000-1003
VTM-UC047-020	VG7481GT

The performance specifications are nominal and conform to acceptable industry standards. For applications at conditions beyond these specifications, consult the local Johnson Controls office. Johnson Controls shall not be liable for damages resulting from misapplication or misuse of its products. © 2019 Johnson Controls. www.johnsoncontrols.com

Cross-Reference of VT Series Union End Valves to VG7000 Series Valves (Continued)

VT Series Union End Valve	VG7000 Series Equivalent
VTM-UC047-094	VG7481GT Plus VG7000-1012
VTM-UC047-312	VG7481GT+3008B
VTM-UC047-313	VG7481GT+3008D
VTM-UC047-314	VG7481GT+3008E
VTM-UC047-322	VG7481GT+3003B
VTM-UC047-323	VG7481GT+3003D
VTM-UC047-324	VG7481GT+3003E
VTM-UC047-394	VG7481GS+3801E
VTM-UC047-3P4	VG7481GT+3008EP
VTM-UC047-413	VG7481GS+3801D
VTM-UC047-414	VG7481GS+3801E
VTM-UC047-520	VG7481GT+7152G
VTM-UM007 (Slotted Stem)	VG7882Cx
VTM-UM007-012	VG7882CT Plus VG7000-1001
VTM-UM007-013	VG7882CT Plus VG7000-1002
VTM-UM007-014	VG7882CT Plus VG7000-1003
VTM-UM007-020	VG7882CT
VTM-UM007-094	VG7882CT Plus VG7000-1012
VTM-UM007-200	VG7882CS+8020G
VTM-UM007-220	VG7882CS+8022G
VTM-UM007-312	VG7882CT+3008B
VTM-UM007-313	VG7882CT+3008D
VTM-UM007-314	VG7882CT+3008E
VTM-UM007-322	VG7882CT+3003B
VTM-UM007-323	VG7882CT+3003D
VTM-UM007-324	VG7882CT+3003E
VTM-UM007-394	VG7882CS+3801E
VTM-UM007-3P3	VG7882CT+3008DP
VTM-UM007-413	VG7882CS+3801D
VTM-UM007-414	VG7882CS+3801E
VTM-UM007-500	VG7882CT+8050G
VTM-UM007-510	VG7882CT+8051G
VTM-UM007-520	VG7882CT+7152G
VTM-UM007-700	VG7882CT+7150G
VTM-UM007-720	VG7882CT+7152G
VTM-UM007-730	VG7882CT+7153G
VTM-UM019 (Slotted Stem)	VG7882Ex
VTM-UM019-012	VG7882ET Plus VG7000-1001
VTM-UM019-013	VG7882ET Plus VG7000-1002
VTM-UM019-014	VG7882ET Plus VG7000-1003
VTM-UM019-020	VG7882ET
VTM-UM019-094	VG7882ET Plus VG7000-1012
VTM-UM019-200	VG7882ES+8020G
VTM-UM019-220	VG7882ES+8022G
VTM-UM019-312	VG7882ET+3008B
VTM-UM019-313	VG7882ET+3008D
VTM-UM019-314	VG7882ET+3008E
VTM-UM019-322	VG7882ET+3003B
VTM-UM019-323	VG7882ET+3003D
VTM-UM019-324	VG7882ET+3003E
VTM-UM019-394	VG7882ES+3801E
VTM-UM019-3P3	VG7882ET+3008DP
VTM-UM019-413	VG7882ES+3801D
VTM-UM019-414	VG7882ES+3801E
VTM-UM019-500	VG7882ET+8050G
VTM-UM019-510	VG7882ET+8051G
VTM-UM019-520	VG7882ET+7152G
VTM-UM019-700	VG7882ET+7150G
VTM-UM019-720	VG7882ET+7152G
VTM-UM019-730	VG7882ET+7153G
VTM-UM047 (Slotted Stem)	VG7882Gx
VTM-UM047-012	VG7882GT Plus VG7000-1001
VTM-UM047-013	VG7882GT Plus VG7000-1002
VTM-UM047-014	VG7882GT Plus VG7000-1003
VTM-UM047-020	VG7882GT
VTM-UM047-094	VG7882GT Plus VG7000-1012
VTM-UM047-200	VG7882GS+8020G
VTM-UM047-220	VG7882GS+8022G
VTM-UM047-312	VG7882GT+3008B
VTM-UM047-313	VG7882GT+3008D
VTM-UM047-314	VG7882GT+3008E
VTM-UM047-322	VG7882GT+3003B
VTM-UM047-323	VG7882GT+3003D
VTM-UM047-324	VG7882GT+3003E
VTM-UM047-394	VG7882GS+3801E
VTM-UM047-3P3	VG7882GT+3008DP
VTM-UM047-413	VG7882GS+3801D
VTM-UM047-414	VG7882GS+3801E
VTM-UM047-500	VG7882GT+8050G
VTM-UM047-510	VG7882GT+8051G
VTM-UM047-520	VG7882GT+7152G
VTM-UM047-700	VG7882GT+7150G
VTM-UM047-720	VG7882GT+7152G
VTM-UM047-730	VG7882GT+7153G
VTM-UN007 (Slotted Stem)	VG7281Cx
VTM-UN007-012	VG7281CT Plus VG7000-1001
VTM-UN007-013	VG7281CT Plus VG7000-1002
VTM-UN007-014	VG7281CT Plus VG7000-1003
VTM-UN007-020	VG7281CT
VTM-UN007-092	VG7281CT Plus VG7000-1010
VTM-UN007-093	VG7281CT Plus VG7000-1011
VTM-UN007-094	VG7281CT Plus VG7000-1012

VT Series Union End Valve	VG7000 Series Equivalent
VTM-UM019-314	VG7882ET+3008E
VTM-UM019-322	VG7882ET+3003B
VTM-UM019-323	VG7882ET+3003D
VTM-UM019-324	VG7882ET+3003E
VTM-UM019-394	VG7882ES+3801E
VTM-UM019-3P3	VG7882ET+3008DP
VTM-UM019-413	VG7882ES+3801D
VTM-UM019-414	VG7882ES+3801E
VTM-UM019-500	VG7882ET+8050G
VTM-UM019-510	VG7882ET+8051G
VTM-UM019-520	VG7882ET+7152G
VTM-UM019-700	VG7882ET+7150G
VTM-UM019-720	VG7882ET+7152G
VTM-UM019-730	VG7882ET+7153G
VTM-UM047 (Slotted Stem)	VG7882Gx
VTM-UM047-012	VG7882GT Plus VG7000-1001
VTM-UM047-013	VG7882GT Plus VG7000-1002
VTM-UM047-014	VG7882GT Plus VG7000-1003
VTM-UM047-020	VG7882GT
VTM-UM047-094	VG7882GT Plus VG7000-1012
VTM-UM047-200	VG7882GS+8020G
VTM-UM047-220	VG7882GS+8022G
VTM-UM047-312	VG7882GT+3008B
VTM-UM047-313	VG7882GT+3008D
VTM-UM047-314	VG7882GT+3008E
VTM-UM047-322	VG7882GT+3003B
VTM-UM047-323	VG7882GT+3003D
VTM-UM047-324	VG7882GT+3003E
VTM-UM047-394	VG7882GS+3801E
VTM-UM047-3P3	VG7882GT+3008DP
VTM-UM047-413	VG7882GS+3801D
VTM-UM047-414	VG7882GS+3801E
VTM-UM047-500	VG7882GT+8050G
VTM-UM047-510	VG7882GT+8051G
VTM-UM047-520	VG7882GT+7152G
VTM-UM047-700	VG7882GT+7150G
VTM-UM047-720	VG7882GT+7152G
VTM-UM047-730	VG7882GT+7153G
VTM-UN007 (Slotted Stem)	VG7281Cx
VTM-UN007-012	VG7281CT Plus VG7000-1001
VTM-UN007-013	VG7281CT Plus VG7000-1002
VTM-UN007-014	VG7281CT Plus VG7000-1003
VTM-UN007-020	VG7281CT
VTM-UN007-092	VG7281CT Plus VG7000-1010
VTM-UN007-093	VG7281CT Plus VG7000-1011
VTM-UN007-094	VG7281CT Plus VG7000-1012

VT Series Union End Valve	VG7000 Series Equivalent
VTM-UN007-200	VG7281CS+8020G
VTM-UN007-220	VG7281CS+8022G
VTM-UN007-312	VG7281CT+3008B
VTM-UN007-313	VG7281CT+3008D
VTM-UN007-314	VG7281CT+3008E
VTM-UN007-322	VG7281CT+3003B
VTM-UN007-323	VG7281CT+3003D
VTM-UN007-324	VG7281CT+3003E
VTM-UN007-392	VG7281CS+3801B
VTM-UN007-393	VG7281CS+3801D
VTM-UN007-394	VG7281CS+3801E
VTM-UN007-3P2	VG7281CT+3008BP
VTM-UN007-412	VG7281CS+3801B
VTM-UN007-413	VG7281CS+3801D
VTM-UN007-414	VG7281CS+3801E
VTM-UN007-500	VG7281CT+8050G
VTM-UN007-510	VG7281CT+8051G
VTM-UN007-520	VG7281CT+7152G
VTM-UN007-700	VG7281CT+7150G
VTM-UN007-720	VG7281CT+7152G
VTM-UN007-730	VG7281CT+7153G
VTM-UN019 (Slotted Stem)	VG7281Ex
VTM-UN019-012	VG7281ET Plus VG7000-1001
VTM-UN019-013	VG7281ET Plus VG7000-1002
VTM-UN019-014	VG7281ET Plus VG7000-1003
VTM-UN019-020	VG7281ET
VTM-UN019-092	VG7281ET Plus VG7000-1010
VTM-UN019-093	VG7281ET Plus VG7000-1011
VTM-UN019-094	VG7281ET Plus VG7000-1012
VTM-UN019-200	VG7281ES+8020G
VTM-UN019-220	VG7281ES+8022G
VTM-UN019-312	VG7281ET+3008B
VTM-UN019-313	VG7281ET+3008D
VTM-UN019-314	VG7281ET+3008E
VTM-UN019-322	VG7281ET+3003B
VTM-UN019-323	VG7281ET+3003D
VTM-UN019-324	VG7281ET+3003E
VTM-UN019-392	VG7281ES+3801B
VTM-UN019-393	VG7281ES+3801D
VTM-UN019-394	VG7281ES+3801E
VTM-UN019-3P2	VG7281ET+3008BP
VTM-UN019-412	VG7281ES+3801B
VTM-UN019-413	VG7281ES+3801D
VTM-UN019-414	VG7281ES+3801E
VTM-UN019-500	VG7281ET+8050G
VTM-UN019-510	VG7281ET+8051G
VTM-UN019-520	VG7281ET+7152G
VTM-UN019-700	VG7281ET+7150G
VTM-UN019-720	VG7281ET+7152G
VTM-UN019-730	VG7281ET+7153G

Cross-Reference of VT Series Union End Valves to VG7000 Series Valves (Continued)

VT Series Union End Valve	VG7000 Series Equivalent
VTM-UN047 (Slotted Stem)	VG7281Gx
VTM-UN047-012	VG7281GT Plus VG7000-1001
VTM-UN047-013	VG7281GT Plus VG7000-1002
VTM-UN047-014	VG7281GT Plus VG7000-1003
VTM-UN047-020	VG7281GT
VTM-UN047-092	VG7281GT Plus VG7000-1010
VTM-UN047-093	VG7281GT Plus VG7000-1011
VTM-UN047-094	VG7281GT Plus VG7000-1012
VTM-UN047-200	VG7281GS+8020G
VTM-UN047-220	VG7281GS+8022G
VTM-UN047-312	VG7281GT+3008B
VTM-UN047-313	VG7281GT+3008D
VTM-UN047-314	VG7281GT+3008E
VTM-UN047-322	VG7281GT+3003B
VTM-UN047-323	VG7281GT+3003D
VTM-UN047-324	VG7281GT+3003E
VTM-UN047-392	VG7281GS+3801B
VTM-UN047-393	VG7281GS+3801D
VTM-UN047-394	VG7281GS+3801E
VTM-UN047-3P2	VG7281GT+3008BP
VTM-UN047-412	VG7281GS+3801B
VTM-UN047-413	VG7281GS+3801D
VTM-UN047-414	VG7281GS+3801E
VTM-UN047-500	VG7281GT+8050G
VTM-UN047-510	VG7281GT+8051G
VTM-UN047-520	VG7281GT+7152G
VTM-UN047-700	VG7281GT+7150G
VTM-UN047-720	VG7281GT+7152G
VTM-UN047-730	VG7281GT+7153G
VTM-XC007 (Slotted Stem)	VG7491Cx
VTM-XC007-012	VG7491CT Plus VG7000-1001
VTM-XC007-013	VG7491CT Plus VG7000-1002
VTM-XC007-014	VG7491CT Plus VG7000-1003
VTM-XC007-020	VG7491CT
VTM-XC007-094	VG7491CT Plus VG7000-1012
VTM-XC007-312	VG7491CT+3008B
VTM-XC007-313	VG7491CT+3008D
VTM-XC007-314	VG7491CT+3008E
VTM-XC007-322	VG7491CT+3003B
VTM-XC007-323	VG7491CT+3003D
VTM-XC007-324	VG7491CT+3003E
VTM-XC007-394	VG7491CS+3801E
VTM-XC007-3P4	VG7491CT+3008EP
VTM-XC007-413	VG7491CS+3801D
VTM-XC007-414	VG7491CS+3801E
VTM-XC007-520	VG7491CT+7152G

VT Series Union End Valve	VG7000 Series Equivalent
VTM-XC019 (Slotted Stem)	VG7491Ex
VTM-XC019-012	VG7491ET Plus VG7000-1001
VTM-XC019-013	VG7491ET Plus VG7000-1002
VTM-XC019-014	VG7491ET Plus VG7000-1003
VTM-XC019-020	VG7491ET
VTM-XC019-094	VG7491ET Plus VG7000-1012
VTM-XC019-312	VG7491ET+3008B
VTM-XC019-313	VG7491ET+3008D
VTM-XC019-314	VG7491ET+3008E
VTM-XC019-322	VG7491ET+3003B
VTM-XC019-323	VG7491ET+3003D
VTM-XC019-324	VG7491ET+3003E
VTM-XC019-394	VG7491ES+3801E
VTM-XC019-3P4	VG7491ET+3008EP
VTM-XC019-413	VG7491ES+3801D
VTM-XC019-414	VG7491ES+3801E
VTM-XC019-520	VG7491ET+7152G
VTM-XC047 (Slotted Stem)	VG7491Gx
VTM-XC047-012	VG7491GT Plus VG7000-1001
VTM-XC047-013	VG7491GT Plus VG7000-1002
VTM-XC047-014	VG7491GT Plus VG7000-1003
VTM-XC047-020	VG7491GT
VTM-XC047-094	VG7491GT Plus VG7000-1012
VTM-XC047-312	VG7491GT+3008B
VTM-XC047-313	VG7491GT+3008D
VTM-XC047-314	VG7491GT+3008E
VTM-XC047-322	VG7491GT+3003B
VTM-XC047-323	VG7491GT+3003D
VTM-XC047-324	VG7491GT+3003E
VTM-XC047-394	VG7491GS+3801E
VTM-XC047-3P4	VG7491GT+3008EP
VTM-XC047-413	VG7491GS+3801D
VTM-XC047-414	VG7491GS+3801E
VTM-XC047-520	VG7491GT+7152G
VTM-XM007 (Slotted Stem)	VG7892Cx
VTM-XM007-012	VG7892CT Plus VG7000-1001
VTM-XM007-013	VG7892CT Plus VG7000-1002
VTM-XM007-014	VG7892CT Plus VG7000-1003
VTM-XM007-020	VG7892CT
VTM-XM007-094	VG7892CT Plus VG7000-1012
VTM-XM007-200	VG7892CS+8020G
VTM-XM007-220	VG7892CS+8022G

VT Series Union End Valve	VG7000 Series Equivalent
VTM-XM007-312	VG7892CT+3008B
VTM-XM007-313	VG7892CT+3008D
VTM-XM007-314	VG7892CT+3008E
VTM-XM007-322	VG7892CT+3003B
VTM-XM007-323	VG7892CT+3003D
VTM-XM007-324	VG7892CT+3003E
VTM-XM007-394	VG7892CS+3801E
VTM-XM007-3P3	VG7892CT+3008DP
VTM-XM007-413	VG7892CS+3801D
VTM-XM007-414	VG7892CS+3801E
VTM-XM007-500	VG7892CT+8050G
VTM-XM007-510	VG7892CT+8051G
VTM-XM007-520	VG7892CT+7152G
VTM-XM007-700	VG7892CT+7150G
VTM-XM007-720	VG7892CT+7152G
VTM-XM007-730	VG7892CT+7153G
VTM-XM019 (Slotted Stem)	VG7892Ex
VTM-XM019-012	VG7892ET Plus VG7000-1001
VTM-XM019-013	VG7892ET Plus VG7000-1002
VTM-XM019-014	VG7892ET Plus VG7000-1003
VTM-XM019-020	VG7892ET
VTM-XM019-094	VG7892ET Plus VG7000-1012
VTM-XM019-200	VG7892ES+8020G
VTM-XM019-220	VG7892ES+8022G
VTM-XM019-312	VG7892ET+3008B
VTM-XM019-313	VG7892ET+3008D
VTM-XM019-314	VG7892ET+3008E
VTM-XM019-322	VG7892ET+3003B
VTM-XM019-323	VG7892ET+3003D
VTM-XM019-324	VG7892ET+3003E
VTM-XM019-394	VG7892ES+3801E
VTM-XM019-3P3	VG7892ET+3008DP
VTM-XM019-413	VG7892ES+3801D
VTM-XM019-414	VG7892ES+3801E
VTM-XM019-500	VG7892ET+8050G
VTM-XM019-510	VG7892ET+8051G
VTM-XM019-520	VG7892ET+7152G
VTM-XM019-700	VG7892ET+7150G
VTM-XM019-720	VG7892ET+7152G
VTM-XM019-730	VG7892ET+7153G
VTM-XM047 (Slotted Stem)	VG7892xx
VTM-XM047-012	VG7892ET Plus VG7000-1001
VTM-XM047-013	VG7892ET Plus VG7000-1002
VTM-XM047-014	VG7892ET Plus VG7000-1003
VTM-XM047-020	VG7892GT
VTM-XM047-094	VG7892GT Plus VG7000-1012

The performance specifications are nominal and conform to acceptable industry standards. For applications at conditions beyond these specifications, consult the local Johnson Controls office. Johnson Controls shall not be liable for damages resulting from misapplication or misuse of its products. © 2019 Johnson Controls. www.johnsoncontrols.com

Cross-Reference of VT Series Union End Valves to VG7000 Series Valves (Continued)

VT Series Union End Valve	VG7000 Series Equivalent
VTM-XM047-200	VG7892GS+8020G
VTM-XM047-220	VG7892GS+8022G
VTM-XM047-312	VG7892GT+3008B
VTM-XM047-313	VG7892GT+3008D
VTM-XM047-314	VG7892GT+3008E
VTM-XM047-322	VG7892GT+3003B
VTM-XM047-323	VG7892GT+3003D
VTM-XM047-324	VG7892GT+3003E
VTM-XM047-394	VG7892GS+3801E
VTM-XM047-3P3	VG7892GT+3008DP
VTM-XM047-413	VG7892GS+3801D
VTM-XM047-414	VG7892GS+3801E
VTM-XM047-500	VG7892GT+8050G
VTM-XM047-510	VG7892GT+8051G
VTM-XM047-520	VG7892GT+7152G
VTM-XM047-700	VG7892GT+7150G
VTM-XM047-720	VG7892GT+7152G
VTM-XM047-730	VG7892GT+7153G
VTM-XN007 (Slotted Stem)	VG7291Cx
VTM-XN007-012	VG7291CT Plus VG7000-1001
VTM-XN007-013	VG7291CT Plus VG7000-1002
VTM-XN007-014	VG7291CT Plus VG7000-1003
VTM-XN007-020	VG7291CT
VTM-XN007-092	VG7291CT Plus VG7000-1010
VTM-XN007-093	VG7291CT Plus VG7000-1011
VTM-XN007-094	VG7291CT Plus VG7000-1012
VTM-XN007-200	VG7291CS+8020G
VTM-XN007-220	VG7291CS+8022G
VTM-XN007-312	VG7291CT+3008B
VTM-XN007-313	VG7291CT+3008D
VTM-XN007-314	VG7291CT+3008E
VTM-XN007-322	VG7291CT+3003B
VTM-XN007-323	VG7291CT+3003D
VTM-XN007-324	VG7291CT+3003E
VTM-XN007-392	VG7291CS+3801B
VTM-XN007-393	VG7291CS+3801D
VTM-XN007-394	VG7291CS+3801E
VTM-XN007-3P2	VG7291CT+3008BP

VT Series Union End Valve	VG7000 Series Equivalent
VTM-XN007-412	VG7291CS+3801B
VTM-XN007-413	VG7291CS+3801D
VTM-XN007-414	VG7291CS+3801E
VTM-XN007-500	VG7291CT+8050G
VTM-XN007-510	VG7291CT+8051G
VTM-XN007-520	VG7291CT+7152G
VTM-XN007-700	VG7291CT+7150G
VTM-XN007-720	VG7291CT+7152G
VTM-XN007-730	VG7291CT+7153G
VTM-XN019 (Slotted Stem)	VG7291Ex
VTM-XN019-012	VG7291ET Plus VG7000-1001
VTM-XN019-013	VG7291ET Plus VG7000-1002
VTM-XN019-014	VG7291ET Plus VG7000-1003
VTM-XN019-020	VG7291ET
VTM-XN019-092	VG7291ET Plus VG7000-1010
VTM-XN019-093	VG7291ET Plus VG7000-1011
VTM-XN019-094	VG7291ET Plus VG7000-1012
VTM-XN019-200	VG7291ES+8020G
VTM-XN019-220	VG7291ES+8022G
VTM-XN019-312	VG7291ET+3008B
VTM-XN019-313	VG7291ET+3008D
VTM-XN019-314	VG7291ET+3008E
VTM-XN019-322	VG7291ET+3003B
VTM-XN019-323	VG7291ET+3003D
VTM-XN019-324	VG7291ET+3003E
VTM-XN019-392	VG7291ES+3801B
VTM-XN019-393	VG7291ES+3801D
VTM-XN019-394	VG7291ES+3801E
VTM-XN019-3P2	VG7291ET+3008BP
VTM-XN019-412	VG7291ES+3801B
VTM-XN019-413	VG7291ES+3801D
VTM-XN019-414	VG7291ES+3801E
VTM-XN019-500	VG7291ET+8050G
VTM-XN019-510	VG7291ET+8051G
VTM-XN019-520	VG7291ET+7152G
VTM-XN019-700	VG7291ET+7150G
VTM-XN019-720	VG7291ET+7152G
VTM-XN019-730	VG7291ET+7153G

VT Series Union End Valve	VG7000 Series Equivalent
VTM-XN047 (Slotted Stem)	VG7291Gx
VTM-XN047-012	VG7291GT Plus VG7000-1001
VTM-XN047-013	VG7291GT Plus VG7000-1002
VTM-XN047-014	VG7291GT Plus VG7000-1003
VTM-XN047-020	VG7291GT
VTM-XN047-092	VG7291GT Plus VG7000-1010
VTM-XN047-093	VG7291GT Plus VG7000-1011
VTM-XN047-094	VG7291GT Plus VG7000-1012
VTM-XN047-200	VG7291GS+8020G
VTM-XN047-220	VG7291GS+8022G
VTM-XN047-312	VG7291GT+3008B
VTM-XN047-313	VG7291GT+3008D
VTM-XN047-314	VG7291GT+3008E
VTM-XN047-322	VG7291GT+3003B
VTM-XN047-323	VG7291GT+3003D
VTM-XN047-324	VG7291GT+3003E
VTM-XN047-392	VG7291GS+3801B
VTM-XN047-393	VG7291GS+3801D
VTM-XN047-394	VG7291GS+3801E
VTM-XN047-3P2	VG7291GT+3008BP
VTM-XN047-412	VG7291GS+3801B
VTM-XN047-413	VG7291GS+3801D
VTM-XN047-414	VG7291GS+3801E
VTM-XN047-500	VG7291GT+8050G
VTM-XN047-510	VG7291GT+8051G
VTM-XN047-520	VG7291GT+7152G
VTM-XN047-700	VG7291GT+7150G
VTM-XN047-720	VG7291GT+7152G
VTM-XN047-730	VG7291GT+7153G



This product is made of copper alloy, which contains lead. The product is therefore not to be used on drinking water.



This product can expose you to chemicals including lead, which is known to the State of California to cause cancer, birth defects, or other reproductive harm. For more information, go to www.P65Warnings.ca.gov.

WARNING: BRASS MAY CONTAIN LEAD

To fulfill our obligations towards Article 33, in accordance to the European REACH Regulation No 1907/2006 EC, we hereby inform you that this article contains the following Substances of Very High Concern mentioned on the Candidate list:

- Lead

Cross-Reference of Cage Trim Valves to VG7000 Series Valves

Cage Trim Valve	VG7000 Series Equivalent
AV-8050	VG7241/VG7842
AV-8050-1004	VG7241LT+8050G
AV-8050-1005	VG7241NT+7150G
AV-8050-1006	VG7241RT+7150G
AV-8050-1013	VG7842LT+8050G
AV-8050-1014	VG7842NT+7150G
AV-8050-1015	VG7842RT+7150G
AV-8051	VG7241/VG7842
AV-8051-1004	VG7241LT+8051G
AV-8051-1005	VG7241NT+7153G
AV-8051-1006	VG7241RT+7153G
AV-8051-1013	VG7842LT+8051G
AV-8051-1014	VG7842NT+7153G
AV-8051-1015	VG7842RT+7153G
AV-8052	VG7241/VG7441/VG7842
AV-8052-1013	VG7842LT+7152G
AV-8052-1014	VG7842NT+7152G
AV-8052-1015	VG7842RT+7152G
AV-8052-1021	VG7441LT+423GGA
AV-8052-1022	VG7241NT+7152G
AV-8052-1023	VG7441RT+72CHGA
V-3754	VG7241
V-3754-1008	VG7241LT+3008E
V-3754-1010	VG7241NT+3008E
V-3754-1022	VG7241LT+3008B
V-3754-1023	VG7241NT+3008B
V-3754-1026	VG7241LT+3008BP
V-3754-1027	VG7241NT+3008BP
V-3754-1028	VG7241RT+3008B
V-3754-1029	VG7241RT+3008E
V-3754-1030	VG7241RT+3008BP
VB-3754	VG7241
VB-3754-4	VG7241LT
VB-3754-5	VG7241NT
VB-3754-6	VG7241RT
VB-3754-7	VG7241ST
VB-3754-8	VG7241PT
V-3974	VG7441
V-3974-1004	VG7441LT+3008E
V-3974-1005	VG7441NT+3008E
V-3974-1010	VG7441LT+3008EP
V-3974-1011	VG7441NT+3008EP
V-3974-1012	VG7441RT+3008E
VB-3974	VG7441
VB-3974-4	VG7441LT
VB-3974-5	VG7441NT
VB-3974-6	VG7441RT
VB-3974-7	VG7441ST

Cage Trim Valve	VG7000 Series Equivalent
V-4324	VG7842
V-4324-1005	VG7842LT+3008D
V-4324-1006	VG7842LT+3008E
V-4324-1007	VG7842NT+3008D
V-4324-1008	VG7842NT+3008E
V-4324-1013	VG7842LT+3008EP
V-4324-1014	VG7842NT+3008EP
V-4324-1015	VG7842RT+3008D
V-4324-1016	VG7842RT+3008E
V-4324-1017	VG7842RT+3008EP
VB-4324	VG7842
VB-4324-4	VG7842LT
VB-4324-5	VG7842NT
VB-4324-6	VG7842RT
VB-4324-7	VG7842ST
VB-4324-8	VG7842PT
V-5254	VG7241
V-5254-1	VG7241RT+823C00
V-5254-11	VG7241RT+823C01 Plus EP-8000 Series Transducer
V-5254-12	VG7241ST+823C01 Plus EP-8000 Series Transducer
V-5254-2	VG7241RT+823C01
V-5254-3	VG7241RT+823E00
V-5254-4	VG7241ST+823C00
V-5254-5	VG7241ST+823C01
V-5254-6	VG7241ST+823E00
V-5464	VG7441
V-5464-1	VG7441RT+823E00
V-5464-11	VG7441RT+823E01 Plus EP-8000 Series Transducer
V-5464-12	VG7441ST+823E01 Plus EP-8000 Series Transducer
V-5464-2	VG7441RT+823E01
V-5464-3	VG7441ST+823E00
V-5464-4	VG7441ST+823E01
V-5844	VG7842
V-5844-1	VG7842RT+823D00
V-5844-11	VG7842RT+823E01 Plus EP-8000 Series Transducer
V-5844-12	VG7842ST+823E01 Plus EP-8000 Series Transducer
V-5844-2	VG7842RT+823E00
V-5844-3	VG7842RT+823E01
V-5844-4	VG7842ST+823D00
V-5844-5	VG7842ST+823E00
V-5844-6	VG7842ST+823E01
VBC-TCS15	VG7441
VBC-TCS15-820	VG7441RT+72CHGA
VBC-TCS20	VG7441
VBC-TCS20-820	VG7441ST+72CHGA

Cage Trim Valve	VG7000 Series Equivalent
VBC-TMC86	VG7842
VBC-TMC86-700	VG7842LT+7150G
VBC-TMC86-720	VG7842LT+7152G
VBC-TMC86-730	VG7842LT+7153G
VBC-TMS10	VG7842
VBC-TMS10-700	VG7842NT+7150G
VBC-TMS10-720	VG7842NT+7152G
VBC-TMS10-730	VG7842NT+7153G
VBC-TMS12	VG7842
VBC-TMS12-700	VG7842PT+7150G
VBC-TMS12-720	VG7842PT+7152G
VBC-TMS12-730	VG7842PT+7153G
VBC-TMS15	VG7842
VBC-TMS15-700	VG7842RT+7150G
VBC-TMS15-720	VG7842RT+7152G
VBC-TMS15-730	VG7842RT+7153G
VBC-TMS15-800	VG7842RT+7200G
VBC-TMS15-820	VG7842RT+7202G
VBC-TMS15-830	VG7842RT+7203G
VBC-TMS20	VG7842
VBC-TMS20-700	VG7842ST+7150G
VBC-TMS20-720	VG7842ST+7152G
VBC-TMS20-730	VG7842ST+7153G
VBC-TMS20-800	VG7842ST+7200G
VBC-TMS20-820	VG7842ST+7202G
VBC-TMS20-830	VG7842ST+7203G
VBC-TNC86	VG7241
VBC-TNC86-700	VG7241LT+7150G
VBC-TNC86-720	VG7241LT+7152G
VBC-TNC86-730	VG7241LT+7153G
VBC-TNS10	VG7241
VBC-TNS10-700	VG7241NT+7150G
VBC-TNS10-720	VG7241NT+7152G
VBC-TNS10-730	VG7241NT+7153G
VBC-TNS12	VG7241
VBC-TNS12-700	VG7241PT+7150G
VBC-TNS12-720	VG7241PT+7152G
VBC-TNS12-730	VG7241PT+7153G
VBC-TNS15	VG7241
VBC-TNS15-700	VG7241RT+7150G
VBC-TNS15-720	VG7241RT+7152G
VBC-TNS15-730	VG7241RT+7153G
VBC-TNS15-800	VG7241RT+7200G
VBC-TNS15-820	VG7241RT+7202G
VBC-TNS15-830	VG7241RT+7203G
VBC-TNS20	VG7241
VBC-TNS20-700	VG7241ST+7150G
VBC-TNS20-720	VG7241ST+7152G
VBC-TNS20-730	VG7241ST+7153G
VBC-TNS20-800	VG7241ST+7200G
VBC-TNS20-820	VG7241ST+7202G
VBC-TNS20-830	VG7241ST+7203G

Cross-Reference of Cage Trim Valves to VG7000 Series Valves (Continued)



This product is made of copper alloy, which contains lead.
The product is therefore not to be used on drinking water.



This product can expose you to chemicals including lead, which is known to the State of California to cause cancer, birth defects, or other reproductive harm. For more information, go to www.P65Warnings.ca.gov.

WARNING: BRASS MAY CONTAIN LEAD

To fulfill our obligations towards Article 33, in accordance to the European REACH Regulation No 1907/2006 EC, we hereby inform you that this article contains the following Substances of Very High Concern mentioned on the Candidate list:

- Lead

Cross-Reference of V-7x16 Series Valves to VG7000 Series Valves

V-7x16 Series Valve	VG7000 Series Equivalent
V-7216	VG7243
V-7216-4502	VG7243CT+3008B
V-7216-4503	VG7243ET+3008B
V-7216-4505	VG7243GT+3008B
V-7216-4506	VG7243GT+3008B
V-7216-4507	VG7243LT+3008B
V-7216-4515	VG7243GT+821C00
V-7216-4516	VG7243LT+821C00
V-7216-4517	VG7243NT+822C00
V-7216-4518	VG7243PT+822C00
V-7216-4519	VG7243RT+823C00
V-7216-4521	VG7243PT+822C00
V-7216-4522	VG7243RM+843C00
V-7216-4523	VG7243SM+843C00
V-7216-4552	VG7243CT+3008BP
V-7216-4553	VG7243ET+3008BP
V-7216-4555	VG7243GT+3008BP
V-7216-4557	VG7243LT+3008BP
V-7216-4564	VG7243GT+821C01
V-7216-4565	VG7243GT+821C01
V-7216-4566	VG7243LT+821C01
V-7216-4567	VG7243NT+822C01
V-7216-4571	VG7243PT+822C01
V-7216-4572	VG7243RM+843C01
V-7216-4573	VG7243SM+843C01

V-7x16 Series Valve	VG7000 Series Equivalent
V-7416	VG7443
V-7416-4502	VG7443CT+3008E
V-7416-4503	VG7443ET+3008E
V-7416-4505	VG7443GT+3008E
V-7416-4506	VG7443GT+3008E
V-7416-4507	VG7443LT+3008E
V-7416-4515	VG7443GT+821E00
V-7416-4516	VG7443LT+821E00
V-7416-4517	VG7443NT+822E00
V-7416-4518	VG7443PT+822E00
V-7416-4519	VG7443RT+823E00
V-7416-4521	VG7443PT+822E00
V-7416-4522	VG7443RM+843E00
V-7416-4523	VG7443SM+843E00
V-7416-4552	VG7443CT+3008EP
V-7416-4555	VG7443GT+3008EP
V-7416-4557	VG7443LT+3008EP
V-7416-4563	VG7443GT+821E01
V-7416-4565	VG7443GT+821E01
V-7416-4566	VG7443LT+821E01
V-7416-4567	VG7443NT+822E01
V-7416-4571	VG7443PT+822E01
V-7416-4572	VG7443RM+843E01
V-7416-4573	VG7443SM+843E01



This product is made of copper alloy, which contains lead. The product is therefore not to be used on drinking water.



This product can expose you to chemicals including lead, which is known to the State of California to cause cancer, birth defects, or other reproductive harm. For more information, go to www.P65Warnings.ca.gov.

WARNING: BRASS MAY CONTAIN LEAD

To fulfill our obligations towards Article 33, in accordance to the European REACH Regulation No 1907/2006 EC, we hereby inform you that this article contains the following Substances of Very High Concern mentioned on the Candidate list:

- Lead

Johnson Controls offers a broad line of innovative, high performing and energy-saving HVAC and refrigeration controls

REFRIGERATION CONTROLS



VARIABLE SPEED DRIVES



VALVES



ACTUATORS



SENSORS & THERMOSTATS



HVAC CONTROL PANEL PRODUCTS



DAMPERS, LOUVERS & AIR MEASURING PRODUCTS



PNEUMATICS



We are in the business of building efficiency. We create buildings and environments that help people achieve and enterprises succeed. We do that by delivering energy savings. Operational savings. And sustainable solutions.

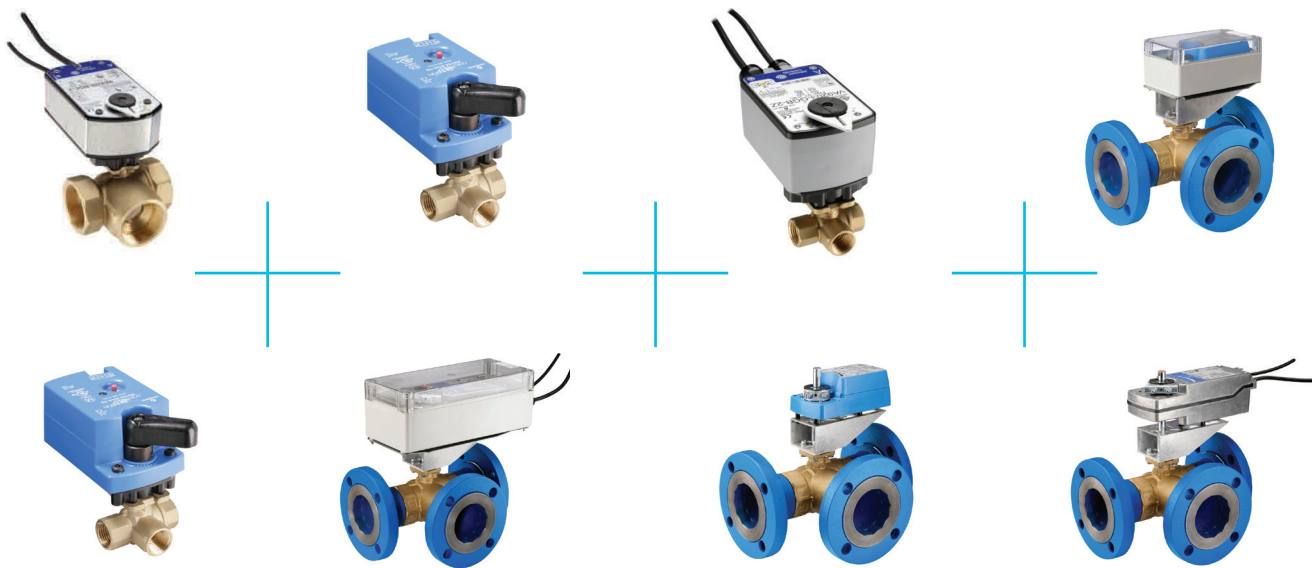

For more information, or to purchase Johnson Controls products, call 1-800-275-5676 or 1-800-482-2778.

Johnson Controls and the Johnson Controls logo are registered trademarks of Johnson Controls, Inc. in the United States of America and other countries. Other trademarks used herein may be trademarks or registered trademarks of other companies.

© 2019 Johnson Controls P.O. Box 423, Milwaukee, WI 53201 All rights reserved worldwide Printed in USA PUBL-9082 (Rev. 3/19) www.johnsoncontrols.com

