

EVAPORATIVE CONDENSERS



Reliable products with long-term, low cost of ownership

For Industrial Refrigeration



Frick[®]

BY JOHNSON CONTROLS



Why buy FRICK products?

FRICK HISTORY INCLUDES A GREAT REPUTATION FOR MAKING RELIABLE PRODUCTS



Frick began building quality products in Waynesboro, PA, USA in 1853. We built our first refrigeration compressor in 1883 and have been on the cutting edge of technology ever since. Each year, Frick continues to be stronger and strengthens its reputation for reliability, great engineering and application knowledge.

PART OF JOHNSON CONTROLS



As a part of Johnson Controls, Frick has access to the technical and financial resources of a Fortune 100 company. This allows us to share knowledge among our various sales and service organizations around the world.

FRICK FACTOR NETWORK



When you purchase a Frick industrial refrigeration system from a Frick Factor you get all of the benefits of Frick product and service experience of over 150 years. To be a Frick Factor you must have great skills in understanding customers' complex processes, product applications, and be able to provide excellent installations and service.

STATE-OF-THE-ART TECHNOLOGY IN BOTH DESIGN AND MANUFACTURING

We lead the industrial refrigeration industry with cutting edge controls technologies that allow for seamless system integration. Our product innovations continue to be a major focus as we strive to bring tomorrow's products to the marketplace today.

ENGINEERING EXCELLENCE

Frick products have been around for a very long time. Our engineers have continually refined existing products, adding the newest technologies as time passes. This constant evaluation of products ensures that Frick will always deliver customer satisfaction by providing the most reliable equipment in the industry. We often make changes to improve the performance of current products with the intent that they can be applied to previous installations. This allows continual upgrades to existing equipment.

QUALITY, SATISFACTION AND RELIABILITY

The Industrial refrigeration industry places high demands on the equipment it uses. Today's equipment must be easy to maintain and meet high standards for quality, reliability and energy efficiency. Unit designs must be compact and easily installed. Frick products accomplish all of these goals. High quality materials, innovative design and modern manufacturing methods add up to a product that is unmatched in overall quality. JOHNSON CONTROLS QUALITY POLICY - We will deliver products and services that conform to our customer's requirements and strive to exceed their expectations.

ENERGY EFFICIENT

Facility owners are paying more attention to energy efficiency now more than ever before. Executives who oversee energy efficiency investments expect a reasonable payback period. Many years of experience in the industrial refrigeration industry has allowed Frick to provide several options of energy efficient solutions for your system. For example, our VSD drives with unique liquid cooling are factory mounted to lower installation costs. Our cutting edge designs, along with our own engineered control systems and the use of VSDs can dramatically reduce operating costs.



ENGINEERED CONTROL SYSTEMS FEATURE Q-NET TECHNOLOGY

Get optimum performance when you use Q-Net to take control of your refrigeration system. View, monitor and control your entire system by changing setpoints; react to system changes from one location because everything is linked. Our constant evaluation of best practices regarding energy conservation and system performance keeps pace with current technologies and sets the standard by which competition is gauged. We offer nearly limitless expansion of your controls capability to keep pace with controls technology. Select from complete PLC based Engineered Control Systems to Q-Net Technology panels.



SUPERIOR SYSTEM INTEGRATION

Our expertise in each product area means a better understanding of how to build a complete and superior refrigeration system with integrated controls. This complete system integration allows for a dependable, efficient and sustainable refrigeration system.

Evaporative Condensers

Evaporative condensers provide heat rejection for many types of systems, and the specific application will largely determine which Frick Evaporative Condenser is best suited for a project.

The information contained within this brochure is geared towards the use of evaporative condensers in the industrial refrigeration market.

Evaporative condensers are used to provide lower condensing temperatures and compressor horsepower savings of up to 15 percent when compared with traditional systems. For technical support with a refrigeration application, contact your local Frick Refrigeration Sales Representative.

COOLWARE



Coolware selection software is used to determine the best system components for a complete refrigeration system.

It allows models to be selected, priced and placed directly into an order document to assure that exactly the right equipment is ordered. It also provides flexibility in design considerations to provide a total system that is green, sustainable and efficient. Coolware is the most sophisticated and complete software in the Industrial Refrigeration business.

WE ARE ENVIRONMENTALLY GREEN

*NATURAL
REFRIGERANTS
DON'T LEAVE A
FOOTPRINT!*

Ammonia and CO₂ are the primary refrigerants used for industrial refrigeration. Both are natural refrigerants that are environmentally friendly and have low Ozone Depletion Potential (ODP) and low Global Warming Potential (GWP).

AFTERMARKET SERVICE

If you have FRICK equipment, it is our policy to support it. Our technical support does not end with the warranty. The Baltimore Parts Center online ordering system is designed to help Frick® Factors obtain parts fast. Prompt and accurate service is always a priority. We also offer a Priority order service to expedite in stock parts orders when they require same day shipment.

Principle of Operation

The vapor to be condensed is circulated through a condensing coil, which is continually wetted on the outside by a recirculating water system. Air is pulled over the coil, causing a small portion of the recirculating water to evaporate. The evaporation removes heat from the vapor in the coil, causing it to condense.



Efficient, Long Lasting Evaporative Condensers Designed to Meet Your Application Needs!

ECH

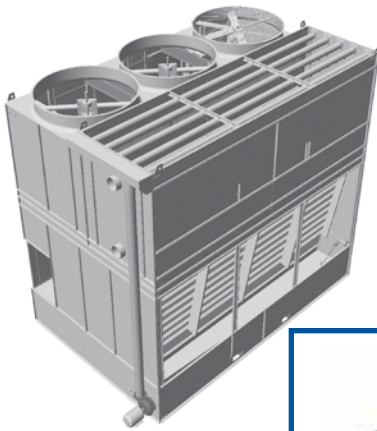

ECH-D

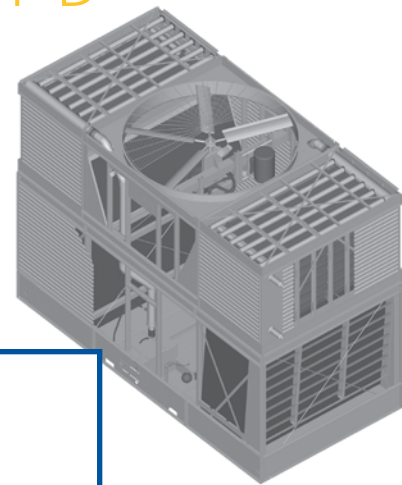

XLP2



ECC



ECL

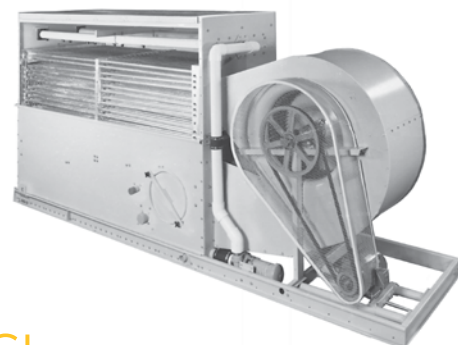

Customer Focus puts you in the picture!

Frick® manufactures a broad product line to ensure your project needs are met. And our custom catwalks with full-sized manways give safe, easy service access to all areas of your condenser.



Features & Benefits

All Models

Easy Maintenance

- **Internal Access** – The interior of the unit is spacious and easily accessible via multiple large hinged access doors for adjusting the float valve, cleaning the strainer, or flushing the basin.
- **Basin Sweeper System** – The basin contains an optional piping system to sweep away sediment.
- **Harmony™ Removal System** – Water distribution branch removal system that requires no tools.

Reliable Year-Round Operation

- **Drive System** – The fans, motor, and drive system are located to protect them from moisture, condensation and icing. Backed by a 5-year fan drive and motor warranty, these units are suitable for year-round operation.
- **HDGAF Coil** – The coil is hot dip galvanized after fabrication.

Low Installed Cost

- **Support** – All models mount directly on two parallel I beams and ship complete with motors and drives factory installed and aligned.
- **Modular Design**– Large models ship in multiple sections to minimize the size and weight of the heaviest lift, allowing for the use of smaller, less costly cranes.

Green (Energy Saving)

- **PE VFD Motors** – Fan motors are premium efficient inverter duty.
- **VFD** – Variable frequency fan motor drives are optional.
- **Design** – Evaporative condensers lower the condensing temperature saving up to 15% compared to a traditional condenser.



Features & Benefits

ALL MODELS

Serpentine Coil

- Constructed of continuous lengths of all prime surface steel, hot-dip galvanized after fabrication.
- Galvanizing is on the outside surface of the coil, designed for low pressure drop with sloping tubes for free drainage of fluid.

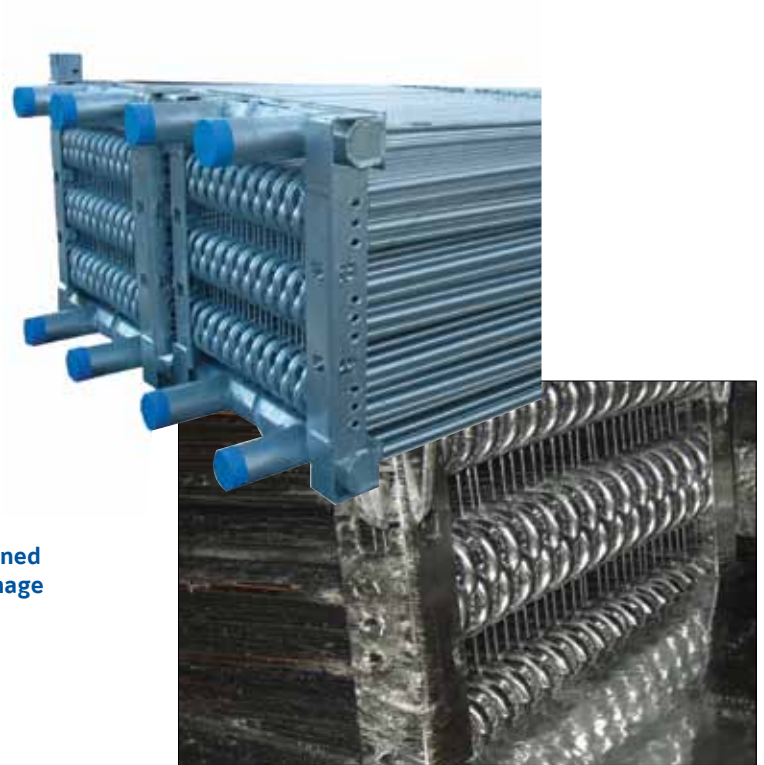

Coil – Hot-dip Galvanized after Fabrication process.

Features & Benefits

Harmony™ Spray System

- Snap in/out nozzles, no tools required to remove and inspect.
- Large orifice
- Nonrotating 360° overlapping dual-umbrella spray pattern
- Harmony™ Removal System – Water distribution branch removal system that requires no tools.



Features & Benefits



XLP2

Low Energy Consumption

- Evaporative condensers minimize the energy consumption of the entire system by providing lower condensing temperatures. Owners save money while conserving natural resources and reducing environmental impact.
- XLP2 Evaporative Condensers provide the heat rejection required at the lowest possible energy via:
 - High efficiency, low horsepower axial fans
 - Premium efficient/VFD duty motors (standard)
 - Variable Frequency Drives (Optional)
 - Multiple fan models allow for capacity staging

Easy Maintenance

- Access Doors – Two 30" x 42" access doors are standard on side blow units and one on end blow units. This allows the interior of the unit to be easily accessed for adjusting the float valve, cleaning the strainer or flushing the basin. A large hinged internal partition door and an external door step are standard on all units.
- Hygienic Cold Water Basin – The cold water basin is sloped to eliminate stagnant water and reduce biological growth. Additionally, the suction strainer is easily removed to simplify maintenance.
- Fan Motors – The fan motors for the XLP2 models are mounted in a horizontal position on an adjustable base. To aid belt tensioning and changing, the base is easily adjusted by turning one large nut.

ECH & ECH-D

Panels

- Panels are standard G-235 hot-dip galvanized heavy-duty construction on ECH and FRP on ECH-D

Fortitude™ drive train

- Solid-backed multigrooved belt
- Corrosion resistant cast aluminum sheaves
- Heavy-duty bearings L₁₀ 40,000 hours on ECH and 80,000 hours on ECH-D
- Premium efficient inverter duty fan motors are standard
- 5-year warranty

Fans

- Low horsepower axial
- Dual fans with guide vanes
- Heavy-duty cast aluminum
- Corrosion resistant
- Quiet operation

Water distribution system

- Visible and accessible during operation
- Overlapping dual-umbrella spray patterns ensure proper water coverage
- Nonrotating 360° nonclog nozzles
- Corrosion resistant
- Snap in/out nozzles – no tools required

Coil section

- Continuous serpentine steel tubing
- HDGAF
- Sloped tubes for draining
- Smaller coil
- ASME 31.5 compliant
- Canadian orders are CRN

Wet deck fill and drift eliminators

- PVC
- Impervious to rot, decay, and biological attack
- Flame spread rating of 5 per ASTM E84

FRP air inlet louvers

- Corrosion resistant
- UV-resistant finish
- Maintenance free

Cold water basin

- Sloped for easy cleaning
- G-235 hot-dip galvanized
- Suction strainer with anti-vortex hood accessible from louver face
- Adjustable water makeup assembly accessible from louver face
- Integral internal walkway

Recirculated spray water pump

- Close-coupled bronze-fitted centrifugal pump
- TEFC fan-cooled motor
- Bleed line with metering valve installed from pump discharge to overflow

Hinged access doors

- Inward swinging large access doors on each end wall

Options

All Models

- Smooth Link™ piping
- Basin sweeper system
- Basin heaters
- Water level controls
- Remote sump
- 304 SS coil
- ASME "U" stamp
- Equipment starters & controls
- Coil circuiting
- Vibration cutout switch



Options - XLP2

- Pre-assembled platforms
- DuraTest™ construction
- TripleGuard™ basin corrosion protection system
- SS construction with welded basin
- Wiring to terminal box
- Heavy gauge coil
- 5 FPI extended surface coil
- UniLink™ alignment



Options - ECC

The Frick Fan System

Two standard assemblies. One sized for Full speed & load. The second, 2/3 speed and consumes only 1/3 of design HP.

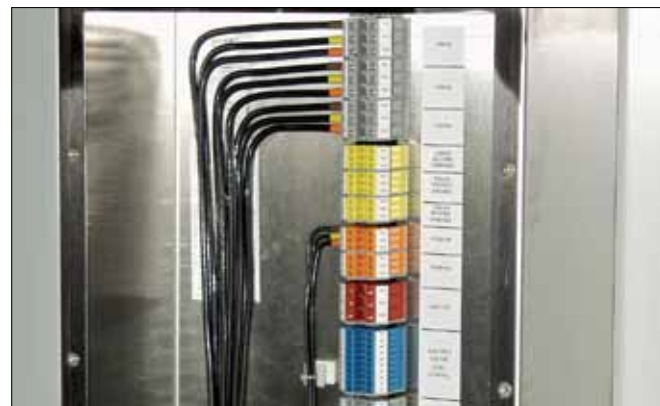



Options

Options - ECH & ECH-D

- Platforms and ladders, both external and internal
- Redundant pump
- Sound attenuation
- Air and debris screens
- Low sound fans
- Anchorage options
- Sentinel™ fan system (standby motor)
- Sentinel™ PLUS fan system
- Gear drive fan system (ECH-D only)
- Independent fan drive
- Basinless (ECH-D only)

External Service Platforms

For external service, lower face and access door platforms can be added to the unit when purchased or as an aftermarket item. Safety cages and safety gates are also available. All components are designed to meet OSHA requirements.

Internal Service Platforms

For access to the motor and drive assemblies on ECH and ECH-D, an internal ladder and upper service platform with handrails is available. Safety gates are also available for all handrail openings, designed to meet OSHA requirements.

Basin Heaters

Evaporative condensers which are exposed to below freezing ambient temperatures require protection to prevent freezing of the water in the cold water basin when the unit is idle. Factory installed electric immersion heaters are a simple and inexpensive way of providing protection.

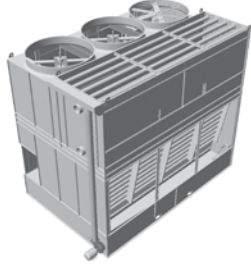
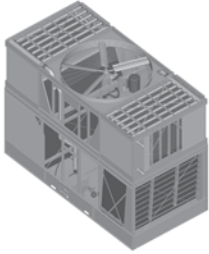

Specifications

Specifications	<p>XLP2</p> 	<p>ECH</p> 	<p>ECH-D</p> 
Standard Casing Corrosion Protection	G-235 (Z700 metric) Hot-Dip Galvanized steel panels	G-235 (Z700 metric) Hot-Dip Galvanized steel panels	G-235 (Z700 metric) Hot-Dip Galvanized steel panels
Basin Corrosion Protection	G-235 Galvanized steel	G-235 Galvanized steel	G-235 Galvanized steel
Fan Guard Corrosion Protection	G-235 (Z700 metric) Hot-Dip Galvanized	G-235 (Z700 metric) Hot-Dip Galvanized	G-235 (Z700 metric) Hot-Dip Galvanized
Coil Test Pressure, psig	375	375	375
Maximum Working Pressure, psig	300	300	300
Fan Type	Heavy-Duty axial flow with aluminum blades	Heavy-Duty axial flow with aluminum blades	Heavy-Duty axial flow with aluminum blades
Nozzle Type	Large Orifice 360° Non-Clog	Large Orifice 360° Non-Clog	Large Orifice 360° Non-Clog
Capacity Control	Variable Frequency Drives, Independent Fan Operation	Variable Frequency Drives, Independent Fan Operation*, & the Frick 1/3-2/3 Fan System options are available. *on select models	Variable Frequency Drives, Independent Fan Operation, & the Frick 1/3-2/3 Fan System options are available.
Ease of Maintenance Features	Two 30" x 42" Access Doors standard to adjust float valve, clean strainer & flush basin. Cold water basin sloped to eliminate water and reduce biological growth.	Hinged access doors provide easy access to the unit interior.	Hinged access doors and a standard internal walkway (available on single air inlet models) provide easy access to the unit interior.
Noise Abatement	Sound level at full fan speed, Max.76 (dB)	Sound level at full fan speed, Max.76 (dB)	Sound level at full fan speed, Max.76 (dB)
Motor Design, Pump and Fan	Totally Enclosed Motors	Totally Enclosed Motors	Totally Enclosed Motors
Fully Factory Assembled Pan and Water Spray Tested	Yes, complete factory testing is included on all condensers	Yes, complete factory testing is included on all condensers	Yes, complete factory testing is included on all condensers
Ease of Assembly	Standard Unit. Coil and Pan Shipped Assembled, Easy Pan Section Mounting	Standard Unit. Coil and Pan Shipped Assembled, Easy Pan Section Mounting	Standard Unit. Coil and Pan Shipped Assembled, Easy Pan Section Mounting



Specifications

Specifications	ECC	ECL
Standard Casing Corrosion Protection	 <p>G-235 (Z700 metric) Hot-Dip Galvanized steel panels</p>	 <p>G-235 (Z700 metric) Hot-Dip Galvanized steel panels</p>
Corrosion Protection	G-235 Galvanized steel	G-235 Galvanized steel
Fan Guard Corrosion Protection	G-235 (Z700 metric) Hot-Dip Galvanized	G-235 (Z700 metric) Hot-Dip Galvanized
Coil Test Pressure, psig	375	375
Design Operating Pressure, psig	300	300
Fan Type	Dynamically balanced, forward curved centrifugal fans, V-belt drive	Dynamically balanced, forward curved centrifugal fans, V-belt drive
Nozzle Type	Large Orifice 360° Non-Clog	Large Orifice 360° Non-Clog
Capacity Control	Variable Frequency Drives, Independent Fan Operation, & the Frick 1/3-2/3 Fan System options are available.	Variable Frequency Drives, Independent Fan Operation, & the Frick 1/3-2/3 Fan System options are available.
Ease of Maintenance Features	Internal access to adjust float valve, clean strainer & flush basin. Cold water basin sloped to eliminate water and reduce biological growth	Hinged access doors provide easy access to the unit interior.
Noise Abatement	For extreme sound sensitive applications, factory designed sound attenuation is available.	For extreme sound sensitive applications, factory designed sound attenuation is available.
Motor Design, Pump and Fan	Totally Enclosed Motors	Totally Enclosed Motors
Fully Factory Assembled Pan and Water Spray Tested	Yes, complete factory testing is included on all condensers	Yes, complete factory testing is included on all condensers
Ease of Assembly	Standard Unit. Coil and Pan Shipped Assembled, Easy Pan Section Mounting. Containerized version for export shipment	Standard Unit. Coil and Pan Shipped Assembled, Easy Pan Section Mounting

MODEL XLP2

Traditional Evaporative Condenser

XLP2 models are traditional forced draft evaporative condensers with axial fans to minimize energy consumption. The XLP2 models have been designed to address the energy efficiency, reliability, maintainability, and field assembly needs of the market. These benefits provide the end user with long service life, and ease of installation and commissioning for the contractor.



Traditional forced draft evaporative condenser with axial fans designed for energy efficiency, reliability, maintainability, and easy field assembly.

CAPACITY RANGE (TR)	
Ammonia	90-1,430
R-507	120-2,000

Standard Features
Axial fan
HDGAF coil
VFD motor

- Forced draft
- Energy saving
- Superior corrosion protection
- HDGAF coil assembly
- TripleGuard™ (option) 5-year warranty basin
- Full-size hinged access doors
- Premium efficient VFD motors
- Independent drive system
- International Building Code (IBC) compliant
- Easy assembly



MODEL XLP2

Traditional Evaporative Condenser

Construction Details

Heavy Duty Construction

- G-235 (Z700 metric) hot-dip galvanized steel panels

Water Distribution System

- Schedule 40 PVC spray branches
- Large orifice, 360° nonclog nozzles
- Nozzles and spray branches snap in/out for easy maintenance

Coil

- Continuous serpentine, steel tubing
- Hot-dip galvanized after fabrication (HDGAF)
- Pneumatically tested at 375 psig
- Sloped tubes for free drainage of fluid
- ASME B31.5 compliant
- Orders shipping into Canada are supplied with a CRN (Canadian Registration Number)

Drift Eliminators

- Polyvinyl chloride (PVC)
- Impervious to rot, decay, and biological attack
- Flame spread rating of 5 per ASTM E84
- Assembled in easy to handle sections

Independent Fan Drive System

- Premium quality, solid-backed, multigroove belt
- Heavy-duty bearings L₁₀ 94,000 hours
- Extended lubrication lines
- Premium efficient/VFD Duty fan motors are standard
- 5-year motor and drive warranty

Low Horsepower Axial Fan(s)

- Corrosion resistant

Recirculating Spray Pump

- Close-coupled, bronze, fitted centrifugal pump
- Totally enclosed fan cooled (TEFC) motor
- Bleed line with metering valve installed from pump discharge to overflow

Access Door

- Interior of unit is easily accessible
- Two 30" x 42" access doors are standard on side blow units
- One 30" x 42" access door is standard on end blow units

Strainer

- Anti-vortexing design to prevent air entrainment

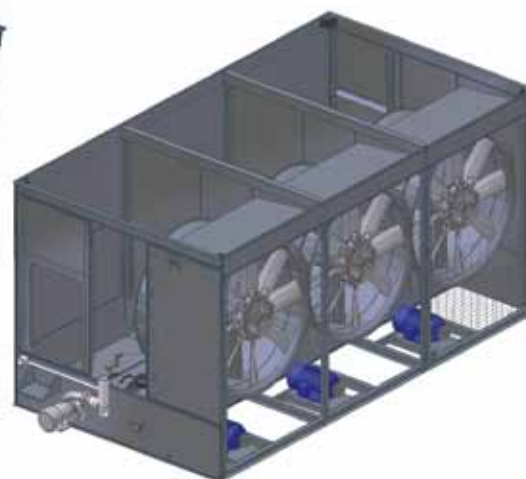

MODEL ECH

Evaporative Condenser Hybrid

ECH models deliver efficient performance in an easy-to-maintain package. Our combined flow technology provides maximum capacity at the lowest refrigerant charge available in the industry by incorporating fill media into the traditional evaporative condenser. In addition, ECH models are designed to mount directly on existing support steel of both crossflow and counterflow units, making them a direct replacement option for almost any existing model.

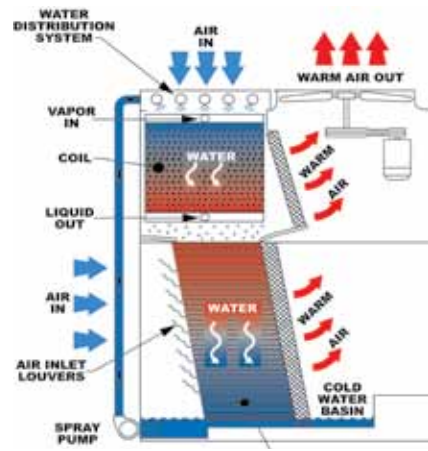
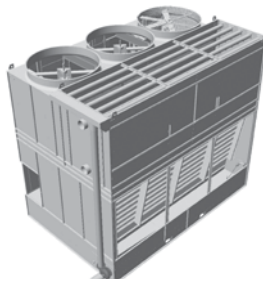

Combined flow technology – combines wet deck with traditional spray coil heat transfer for maximized capacity at lowest refrigerant charge.

CAPACITY RANGE (TR)	
Ammonia	60-960
R-507	80-1,210

Standard Features
Axial fan
HDGAF coil
VFD motor

- Energy saving
- Easy maintenance
- Increased capacity
- Reduced footprint
- Reduced refrigerant charge
- Reduced coil scaling
- HDGAF coil assembly
- Ideal replacement unit
- Premium Efficient VFD motors
- Welded stainless steel 5-year warranty basin (leak & corrosion)



MODEL ECH-D

Evaporative Condenser Hybrid-Dual Inlet

ECH-D models are the largest factory-assembled evaporative condensers available on the market. The design is similar to that of the ECH, but on a larger scale with two air inlets instead of one. These models provide the same efficient performance and easy-to-maintain package and offer additional benefits for large projects. These benefits include fewer required cells, lower overall fan horsepower, and fewer piping connections, lowering both the cost of installation and ownership.

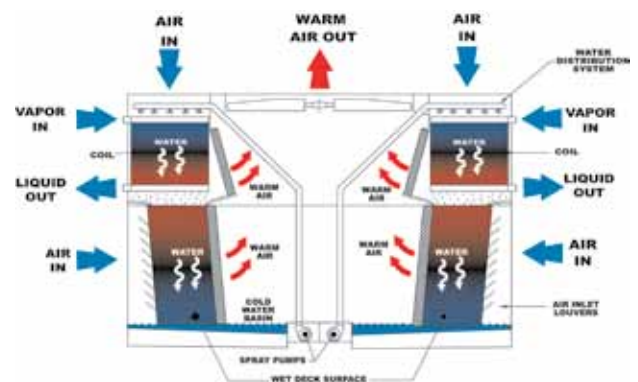
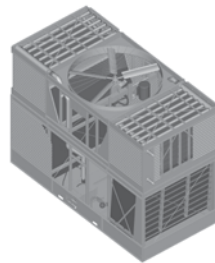

Combined flow technology – combines wet deck with traditional spray coil heat transfer for maximized capacity at lowest refrigerant charge PLUS reduced size in dual package.

CAPACITY RANGE (TR)	
Ammonia	640-1,900
R-507	810-2,360

Standard Features
Axial fan
HDGAF coil
VFD motor

- Energy saving
- Easy maintenance
- Increased capacity
- Reduced footprint
- Reduced refrigerant charge
- Reduced coil scaling
- HDGAF coil assembly
- Ideal replacement unit
- Premium Efficient VFD motors
- Welded stainless steel 5-year warranty basin

MODEL ECH/ECH-D

Evaporative Condenser Hybrid/Plus

Construction Details

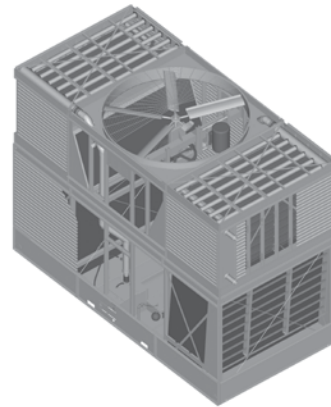
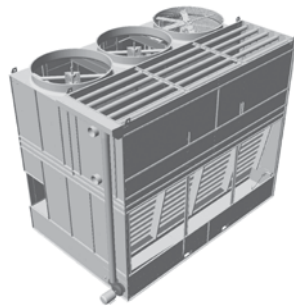

Cross Fill with Integral Drift Eliminators

- Polyvinyl chloride (PVC)
- Impervious to rot, decay and biological attack
- Flame spread rating of 5 per ASTM E84

Heavy-Duty Construction

- G-235 (Z700 metric) hot-dip
- Galvanized steel panels

Power Train

- Premium quality, solid-backed, multigroove belt
- Corrosion resistant cast aluminum sheaves
- Heavy-duty bearings
- L₁₀ 40,000 hours (ECH) 80,000 (ECH-D)
- Premium efficient/inverter duty fan motors are standard
- 5-year motor and drive warranty

Low HP Axial Fan(s)

- High efficiency
- Quiet operation
- Corrosion resistant

Water Distribution System

- Visible and accessible during operation
- Overlapping spray patterns ensure proper water coverage
- Large orifice, 360° nonclog nozzles

Coil Section

- Continuous serpentine, steel tubing
- Hot-dip galvanized after fabrication (HDGAF)

- Pneumatically tested at 375 psig
- Sloped tubes for free drainage of fluid
- ASME B31.5 compliant
- Orders shipping into Canada are supplied with a CRN

FRP Air Inlet Louvers

- Corrosion resistant
- UV-resistant finish
- Maintenance free

Cold Water Basin

- Sloped cold water basin for easy cleaning
- Suction strainer with anti-vortex hood accessible from louver face
- Adjustable water make-up assembly accessible from louver face
- Integral internal walkway

Recirculating Spray Water Pump

- Close-coupled, bronze, fitted centrifugal pump
- Totally enclosed fan cooled (TEFC) motor
- Bleed line with metering valve installed from pump discharge to overflow

Hinged Access Doors

- Inward swinging access door on opposite sides



MODEL ECL

Evaporative Low Profile Centrifugal

ECL models are centrifugal fan evaporative condensers that are specifically designed with a low profile. These units fit well into mechanical equipment rooms with low ceilings and are easily hidden behind louvered walls on buildings. Low profile models are available in heights from 5' 2¼" to 8' 4¾".

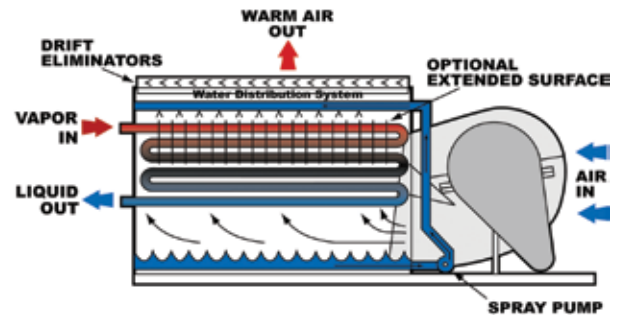
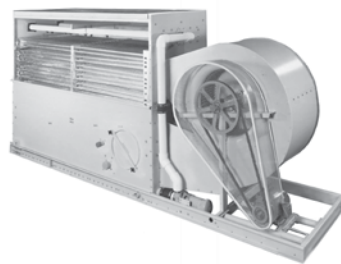

Traditional forced draft evaporative condenser with centrifugal blower(s) designed for low profile to fit into mechanical room with low ceilings or are easily hidden outdoors.

CAPACITY RANGE (TR)	
Ammonia	11-210
R-507	16-290

Standard Features
Centrifugal fan
HDGAF coil
VFD motor

- Forced draft
- Low profile
- Low sound
- Energy saving
- Locate indoor or outdoor
- Superior corrosion protection
- HDGAF coil assembly
- Easy assembly
- Premium efficient VFD motors

MODEL ECC

Evaporative Condenser Centrifugal

ECC models are traditional evaporative condensers with centrifugal fans and are suited to applications where external ductwork or other sources of external static pressure exist.

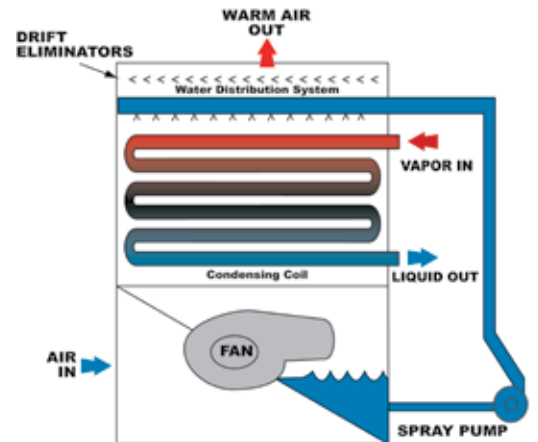
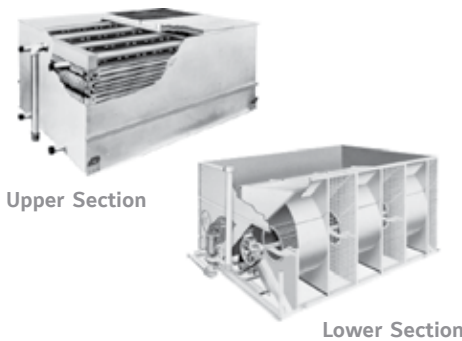

Traditional forced draft evaporative condenser with centrifugal blowers designed for applications where external ductwork or other sources of static pressure exist.

CAPACITY RANGE (TR)	
Ammonia	7-1,140
R-507	10-1,600

Standard Features
Centrifugal fan
HDGAF coil
VFD motor

- Forced draft
- Low sound
- Energy saving
- Locate indoor or outdoor
- Superior corrosion protection
- HDGAF coil assembly
- Easy assembly
- Premium efficient VFD motors



MODEL ECL/ECC

Evaporative Condenser Centrifugal

Construction Details

Heavy Duty Construction

- G-235 (Z700 metric) hot-dip galvanized steel panels

Water Distribution System

- Schedule 40 PVC spray branches
- Large orifice, 360° non-clog nozzles
- Nozzles and spray branches grommetted for easy maintenance

Coil

- Continuous serpentine, steel tubing
- Hot-dip galvanized after fabrication (HDGAF)
- Pneumatically tested at 375 psig
- Sloped tubes for free drainage of fluid
- ASME B31.5 compliant
- Orders shipping into Canada are supplied with a CRN (Canadian Registration Number)

Drift Eliminators

- Polyvinyl chloride (PVC)
- Impervious to rot, decay and biological attack
- Flame spread rating of 5 per ASTM E84
- Assembled in easy to handle sections

Fan Drive System

- V-belt drive
- Heavy-duty bearings
- L₁₀ 40,000 hours
- Premium efficient/VFD Duty fan motors are standard
- 5-year motor and drive warranty

Low Sound Centrifugal Fan(s)

- Quiet operation

Recirculating Spray Pump

- Close-coupled, bronze, fitted centrifugal pump
- Totally enclosed fan cooled (TEFC) motor
- Bleed line with metering valve installed from pump discharge to overflow

Access Door

- Interior of unit is easily accessible

Strainer

- Anti-vortexing design to prevent air entrainment



ECC
Upper Section

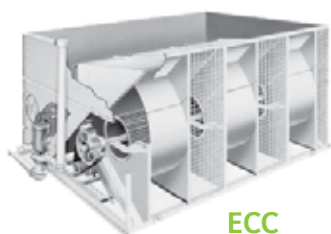

ECC
Lower Section

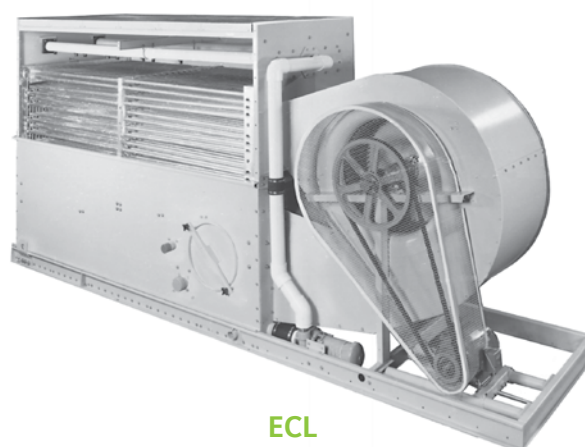

ECL

Quantum™LX Condenser Panel



*Link Your Entire Refrigeration System.
Get Optimum Performance When You
Take Control.*

The Quantum™LX Condenser control optimizes condenser operation to maintain discharge pressure while conserving energy. A Condenser Remote I/O Panel can control up to 23 condensing steps (fans and pumps). These condenser steps are cycled on and off based on discharge pressure changes. Up to 8 variable speed fans can be controlled for more precise and efficient condenser control. Wet bulb control, defrost pressure setpoints and separate summer / winter setpoints are control options.

The Quantum™LX Condenser Interface Panel includes the standard Quantum™LX features and web ready graphics. When the Condenser Remote I/O Panel is used with the Vessel Remote I/O Panel, they are controlled from the same Quantum™LX Condenser / Vessel Interface Panel.



Operator Interface features (Nema 4 Standard, Nema 4X optional):

- Provides ability to view status information and change setpoints.
- Program / setpoints stored on Compact Flashcard.
- Security provides (3) levels of user access
- Language Capability
- Temperature Display
- Pressure Display
- Trending (File transfer capability)
- Setpoint saving (File transfer capability)

- Serial Communication Protocols (Comm#1 Comm#2 and Comm#3)
- Ethernet Communications
- Remote Display Access over Ethernet using an Internet Browser to allow for full access to Quantum™LX. No special software required
- Software updates performed with USB drive at this panel only (No need to update remote panels)

Condenser Remote I/O Control Panel (Nema 4 Standard, Nema 4X optional):

- One Condenser Remote I/O control panel per Condenser / Vessel Operator Interface Panel
- Controls (11) steps of condenser fans or pumps as standard, option available for an additional (12) steps

Control Strategies

- Control Pressure
- Wet Bulb
- Defrost Pressure

Step Types:

- Single / Variable Speed Fan
- Water Pump
- Two-Speed Fan

Step Sequences

- Summer / Winter Control Setpoints with automatic transition

Form 140.00-SG1 (2009-10)

Supersedes: Nothing

Subject to change without notice

Printed in USA • GUI 2M 1009 2.00

© 2009 Johnson Controls, Inc. ALL RIGHTS RESERVED



JOHNSON CONTROLS

100 CV Avenue

Waynesboro, PA 17268 USA

Phone: 717-762-2121 • Fax: 717-762-8624

www.johnsoncontrols.com